

Samson SeceuroDoor Installation Manual Electric Operation



**EMAIL: ENQUIRIES@SAMSONDOORS.CO.UK
TELEPHONE: (01933) 274276
MON - FRI - 8.30AM - 5.30PM**

Introduction

Welcome to our new SecuroDoor Industrial Steel Roller Shutter with GfA motors. This innovative new product has been redesigned from the ground up to provide you, the installer, with a simpler and quicker installation than ever before.

We are convinced this industry leading product will enhance your productivity and efficiency – while being a huge improvement for your end user than has previously been seen!

Follow our new installation instructions to enable your new installation experience. Please feel free to contact our experienced Technical Support team if you have any queries about the product.

Thank you for purchasing our new product!

Colin Reoch, Managing Director, SWS UK



Contents

Introduction	2
Safety Obligations	5
Conformity and CE marking	5
General Operating Information.....	5
Recommended service period	6
Warranty/Life Cycles	6
Site installation safety guidance	6
Installation criteria	6
Introduction to the new SeceuroDoor Industrial Door system	7
Tools required for SeceuroDoor assembly.....	7
Recommended tools for assembly.....	7
Roller shutter parts	8
Parts common to each installation	8
Parts dependent on configuration	8
Parts dependent on optional extras.....	8
General sequence of installation	9
General diagram of variations of layouts.....	9
Installation around an opening	9
Installation within an opening.....	9
SeceuroDoor installation around an opening	10
Check parts and sizes	10
Fit channel angles.....	10
Fit endplates.....	10
Fit axle	10
Fit motor.....	11
Load curtain.....	11
Single skin lath.....	11
Insulated lath.....	12
Attach channels.....	12
Installation within an opening.....	13
Check parts and sizes	13
Fit stand-off angles.....	13
Fit channel angles.....	13
Fit non-drive endplate and brake shelf.....	13
Fit drive-end endplate and axle	14
Fit motor bracket and motor	14
Load curtain.....	14
Single skin lath.....	15
Insulated lath.....	15
Attach channels.....	15
Commission shutter	16
General commissioning sequence	16

Attach motor cable..... 16

Attach Red/Green toggle extension cords 16

Attach hand haul chain extension 16

Mount hand haul chain keep..... 17

Mount control unit 17

Attach control unit cables 17

Set motor limits 18

Adjust operating mode..... 19

Operating mode options 19

Contact us..... 20

Safety Obligations

Your safety, your end user's safety and that of the general public are our primary concern. To that end, please read, understand and follow our advice. These installation instructions are intended for qualified and trained installation engineers. Installation, initial operation, servicing, repairs and dismantling of this product should only be carried out by a qualified and trained installation engineer.

Conformity and CE marking

To comply with the Machinery Directive both the shutter and the motor and controller used in the installation must have a **Declaration of Performance** from the manufacturer.

- On completion of the installation the installer must provide a **Declaration of Conformity** and apply a CE mark giving details of the installations to the shutter/motor and controller combination, which is now classed as a machine.
- The installer must issue to the customer a Declaration of Conformity, operating and maintenance instructions on completion of the installation.
- The installer must hold copies of both the Declaration of Performance and the Declaration of Conformity on a technical file for inspection by the relevant authorities.
- If any of the above requirements are not fulfilled, the installation is illegal.

Please ensure for your own safety and peace of mind that whoever installs your electric motor and controller is both willing and able to fulfil these requirements; if they are not – do not use them. As a member of the DHF we CAN and WILL install your motor and controller safely and legally.

General Operating Information

Upon completion of the installation the end user/operator of the shutter must be trained how to operate the product safely paying particular attention to the following points;

- ✓ The shutter should only be operated when in view
- ✓ The operator must ensure there are no objects or persons in the opening before and during operation.
- ✓ The end user must read and follow the instructions given in the operating and maintenance instructions.
- ✓ In the event of a malfunction the end user should follow the instructions given in the operating and maintenance instructions and if required contact the installer.
- ✓ Their responsibility in law to maintain a regular and appropriate service and maintenance schedule.

Recommended service period

The recommended service period for a shutter which will operate on average two cycles per day is once every 12 months. If the shutter will perform a greater number of cycles per day the service period should be shortened accordingly. One cycle is a full open and close sequence.

Warranty/Life Cycles

The warranty for this product is only granted if;

- ✓ The installation is carried out by a competent installation engineer following these instructions.
- ✓ Only original parts are used.
- ✓ No additional objects are attached to the door.
- ✓ Regular and appropriate maintenance checks are performed.
- ✓ For further details on the product warranties please contact us.
- ✓ To comply with the Construction Products Directive, all products have been durability tested for a minimum of 11,000 cycles.

Site installation safety guidance

This checklist is not exhaustive, but a guidance on the minimum amount of safety levels required. Your company needs to comply with relevant safety directives to ensure your and others' safety. Modern building sites are safe places to work and they will simply not allow an installation to proceed if they are not in agreement with your company's proposal for installation.

- ✓ Relevant work site induction procedures are complete. Permits to work have been obtained as required.
- ✓ Method statements and risk assessments have been read and understood.
- ✓ Appropriate Personal Protective Equipment (PPE) to be used.
- ✓ Site specific hazards are understood and mitigated.
- ✓ Work area cordoned as appropriate.
- ✓ Other trades or persons in area to be briefed as to ongoing installation.
- ✓ Where appropriate, use motorised work platforms for working at height (scissor lifter).
- ✓ Keep work area tidy and free from trip hazards, etc.

Installation criteria

The structure of the opening must be adequate to take the weight of the door and suitable to take the appropriate fixings. The strength of the fixings must be enough to support a minimum weight of 25kg per square metre of the roller shutters. Be aware that this is a dynamic loading.

Introduction to the new SeceuroDoor Industrial Door system

The new SeceuroDoor has been designed to be a flexible system, which easily allows different installation configurations from the same fundamental components. The end the motor is fitted to can now be decided on site, channel angles can simply be reversed on site to have an inset or outset layout. Channel angles are pre-punched to allow adaptability of fitment to the building's structure.

Endplates are reversible and are laser cut to ensure accuracy and aid bearing, brake, motor fitments. The channels can now be fitted to the pre-punched slots in the channel angles with no reworking of the holes. Top slats are now punched and attached to the curtain rather than the axle.

Fittings kits have been thoughtfully sealed in labelled bags which can be selected as required during the installation process. The labels contain information such as the type of fitting, tool required for the fitting and where the fitting goes. We have also rationalised the number of different tools required for the assembly of our new industrial door.

Tools required for SeceuroDoor assembly

The new SeceuroDoor system has fittings pre-bagged in kits specific to each door type. They are labelled clearly indicating the tools required for each kit. This list gives guidance on the tools required for the assembly of the roller shutter.

There are currently 6 different fittings kits, each with their own tool requirement; although there are commonalities throughout the range. The kits are broken up into smaller sections. Broadly; Bearing, Brake (where required), Channel, Endplate and Motor.

If you are unsure on which fittings kit you will receive with your industrial door, please contact us for advice. Generally, we suggest you are equipped with the tools required for all of the kits to ensure you are ready for each eventuality.

Your responsibility as the installer is to have appropriate tools, equipment and fixings appropriate to the installation. Good quality tools are vital to ensure a safe and efficient installation - investment in quality will return productivity dividends. We suggest you have a broad range of tools available.

Recommended tools for assembly

- 13mm ratcheting spanner/socket
- 17mm ratcheting spanner/socket x 2
- 19mm ratcheting spanner/socket x 2
- 24mm spanner/socket x 2
- 27mm spanner/socket x 2 (very large doors only)
- 5mm T-bar allen key
- 6mm allen key
- 8mm allen key
- Large flat bladed screwdriver
- Hand riveter

Roller shutter parts

Whether you have collected your roller shutter or it has been delivered, check you have all the components required before proceeding with installation. Notify SWS UK immediately if there are any parts apparently missing or any damage visible. They will then be able to advise how to proceed. Each roller shutter order will have parts common to each installation, parts dependent on a particular configuration and parts dependent on optional extras.

Parts common to each installation

- ✓ Customer information sheet
- ✓ Assembly drawing
- ✓ Control unit instructions
- ✓ 1 x Axle assembly
- ✓ 1 x Motor
- ✓ 2 x Channel
- ✓ 2 x Channel angles
- ✓ Curtain – several bundles. Labelled from 1, being the top section.
- ✓ 2 x Universal endplates

Parts dependent on configuration

- ✓ Fittings kits
- ✓ Bearings
- ✓ Motor control unit and cables
- ✓ Motor bracket
- ✓ Override kit
- ✓ Drive chain
- ✓ Safety brake and bracket
- ✓ Reveal fitting kit

Parts dependent on optional extras

- ✓ Hood, fascia, motor cover
- ✓ Hood fitting kit
- ✓ Alternate control units
- ✓ Installation instructions specific to optional extras

General sequence of installation

Each SeceuroDoor installation is unique, but they all share some commonalities. The following list gives the intended sequence of installation;

- Read and understand all installation instructions
- Check all parts and sizes
- Fit guide channel angles
- Fit endplates
- Fit axle
- Fit motor
- Load curtain
- Attach guide channels
- Commission shutter

General diagram of variations of layouts

There are many configurations of the SeceuroDoor available, but these two configurations represent the most common variants. Any other configurations will be a variation on the diagrams shown below.

Installation around an opening

This installation arrangement tends to be the most common. You may be aware of it as a 'flag fix', 'face fix' or 'plant on'. The channel angles can easily be swapped to be outset or inset – with inset being the default standard.

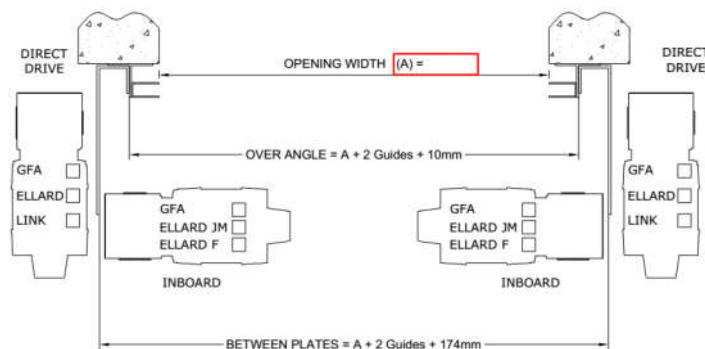

Installation within an opening

This installation arrangement tends to be less common than installations around an opening. You may be aware of it as a 'reveal fix'. The channel angles are designed for an 'outset' fit. Extra stand-off angles are provided, which enable a 'face' to be created to fix the channel angles to.

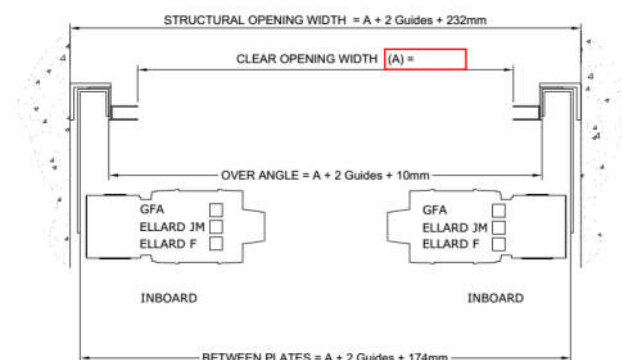

SecuroDoor installation around an opening

Check parts and sizes

With reference to the Customer information sheet and the specific assembly drawing, ensure that all components are present and the size and specification of the supplied roller shutter is appropriate to structural opening before proceeding with installation or dismantling an existing installation.

Fit channel angles

The position of the channel angles around an opening is the most critical part of the installation, as it determines whether the curtain will fit down the channels. The Assembly Drawing will provide you with the dimensions for *Clear Opening Width* and *Back Of Angle* size.

To help ensure a speedy installation process, the channel angles are pre-drilled for fixing to the structure. The installer *must* install using fixings appropriate to the weight of the shutter and the structural integrity.

The *Back Of Angle* size is derived by adding the width of the channels to the thickness of the channel angles. Generally, the *Back Of Angle* size is best used by the installer for initial layout as the channel angles are the first components required to be fitted.

The channel angles *must* be fitted to the correct spacing per the Assembly Drawing, *plumb and parallel* to each other and also the top end of each angle *must* be level with each other.

Fit endplates

The supplied endplates are not handed, so they are reversible. They are pre-drilled and are to be attached to the matching holes on the channel angle. Attach the endplates to the channel angles using the screws, washers and nuts from the 'Endplates' section of the fittings kit. The bolts feed through from the channel angle and the nuts and washers are inside the endplate return flap.

Once the endplates are secured to their channel angles, they must be fitted to the structure. Holes have been pre-drilled in the back face to aid this if required. The endplates must be square and parallel to each other. Sometimes there will be a deflection caused by an uneven structure – this should be compensated for by using shims.

Fit axle

The supplied axle will have a drive end shaft, which has a keyway and is longer than the non-drive end shaft which is plain round. Remove the pre-fitted curtain attachment screws and washers, and keep safe.

Slide one bearing on the non-drive end shaft up to the axle and temporarily tighten a grub screw to stop it sliding off. Remove the keyway key from the drive end shaft and keep safe. Slide the other bearing on the drive end shaft up to the axle and temporarily tighten a grub screw to stop it sliding off.

Lift the axle up to the endplates and slide the drive end shaft through its endplate hole first. Then slide the non-drive end shaft into its hole. The non-drive end bearing now needs to be secured to its pre-drilled endplate holes using the fittings supplied in the 'Bearings' section of the fittings kit. Now secure the drive end bearing to its pre-drilled endplate holes using the fittings supplied in the 'Bearings' section of the fittings kit.

Once both bearings are secured, release the bearing grub screws and align the axle from side to side. The design is such that each end of the axle will align with the inside face of the endplate flap that is

used to attach to the channel angles. This ensures that the curtain will roll up evenly on the axle, as there will be no end-lock overlap.

All bearing grub screws must be firmly tightened at this stage. We suggest carefully removing the grub screws and use a drill to dimple the shaft before tightening the grub screws fully.

Fit motor

The motor is of a direct drive design, so installation is very straightforward. Fit the motor mounting bracket slightly loosely to the appropriate endplate using the fittings from the 'Motor' section of the fittings kit. Re-fit the keyway key to the drive shaft and slide the motor on to the drive shaft. We suggest using a light coating of grease to aid installation, and removal in the future.

Use the fittings from the 'Motor' section of the fittings kit to secure the motor foot plate to the motor mounting bracket. There is movement in the motor bracket and the motor foot plate to allow optimal positioning of the motor. Ensure the drive shaft keyway is evenly positioned within the motor and tighten all nuts and bolts.

Load curtain

The installer may find it easier to load the curtain prior to wiring the control unit by using the manual override haul chain. The motor travel limits can easily be set later in the installation process.

The override drive is engaged by pulling the Red toggle. Pull the haul chain until the axle has rotated to position the curtain attachment screw holes to between horizontal and vertical.

The curtain will be in bundles of approximately 35kg and clearly numbered from 1 (top) in order of attachment. The sections are rolled in their bundles so the top part is presented first. The top lath of the top section has pre-punched slots to enable easy attachment without having to move various attachment strips around.

Offer the top section up to the axle from the far side of the axle and pull over the axle to align the slots with the attachment holes. Loosely fit two screws and washers towards either end of the axle to take the weight of the first curtain section, which can now be uncoiled and hung down. Now ensure the curtain section is aligned evenly between the channel angles. The rest of the screws and washers can now be attached and screwed in firmly, as well as the original loosely attached screws.

The remaining curtain sections can now be installed;

Single skin lath

The bottom lath of each section will be end-locked. There will be enough flexibility in the lath and end-lock to pull it away from the lath to enable the next section of curtain to be slid on. It may help if a medium sized flat bladed screwdriver is used to carefully prise the end-lock clear of the lath. If this is done, ensure that the end-lock is returned to its correct position.

This should be repeated until all of the curtain sections are attached. Depending on the situation, the installer may prefer to haul the curtain up on the haul chain after each section is attached.

Otherwise, the installer can allow the curtain to hang all the way down and attach the last sections from the ground rather than from an access platform. Care should be taken if it is a windy day, as the curtain will act like a large sail.

Once the curtain has been fully installed, haul it up until the bottom lath is hanging about 100mm down from the underside of the endplates.

Insulated lath

The bottom lath of each section will have only one end-lock riveted in place, with the other end-lock loose and ready to be riveted in place. Slide the next section of curtain on from the open end and then rivet the loose end-lock into place with the supplied rivets. If sliding on from the open end isn't possible due to the nature of the structure, take the last lath off the upper section and slide it onto the top of the next section.

This should be repeated until all of the curtain sections are attached. Depending on the situation, the installer may prefer to haul the curtain up on the haul chain after each section is attached.

Otherwise, the installer can allow the curtain to hang all the way down and attach the last sections from the ground rather than from an access platform. Care should be taken if it is a windy day, as the curtain will act like a large sail.

Once the curtain has been fully installed, haul it up until the bottom lath is hanging about 100mm down from the underside of the endplates.

Attach channels

Offer up the appropriate channels to the channel angles. With single skinned curtains, the channel may have welded on tab-stops which will need to be guided over the T-rail bottom lath. With insulated lath curtains there are no tab-stops, so it will be straightforward to position the guide channels.

Loosely fit all the channel screws and nuts to allow optimal positioning of channels before tightening.

Go to 'Commission shutter' section when this section is complete.

Installation within an opening

Check parts and sizes

With reference to the Customer information sheet and the specific assembly drawing, ensure that all components are present and the size and specification of the supplied roller shutter is appropriate to structural opening before proceeding with installation or dismantling an existing installation.

Fit stand-off angles

The stand-off angles must be fitted plumb and parallel to each other. There will be a small allowance in the size of the roller shutter to allow for any structural discrepancies, but you should attempt to fit the angles to the spacing defined in the Customer information sheet and the Assembly Drawing. The installer *must* install using fixings appropriate to the weight of the shutter and the structural integrity.

Fit channel angles

The position of the channel angles around an opening is the most critical part of the installation, as it determines whether the curtain will fit down the channels. The Assembly Drawing will provide you with the dimensions for *Clear Opening Width* and *Back Of Angle* size. The channel angles will always be 'outset' for this configuration.

To help ensure a speedy installation process, the channel angles are pre-drilled for fixing to the stand-off angles. Fittings are supplied in the 'Reveal Fittings Kit' for this purpose.

The *Back Of Angle* size is derived by adding the width of the channels to the thickness of the channel angles. Generally, the *Back Of Angle* size is best used by the installer for initial layout as the channel angles are the first components required to be fitted.

The channel angles *must* be fitted to the correct spacing per the Assembly Drawing, *plumb and parallel* to each other and also the top end of each angle *must* be level with each other.

Fit non-drive endplate and brake shelf

The supplied brake shelf should be fitted to the relevant endplate before fitting endplates to the channel angles. The brake shelf is fitted to the inside of the relevant endplate with the fittings from the 'Brake Pack' of the fittings kit.

These fittings can be tightened at this stage, but be aware that there will be movement on this shelf to allow for minor level discrepancies if required.

The supplied endplates are not handed, so they are reversible. They are pre-drilled and are to be attached to the matching holes on the channel angle. Attach the endplates to the channel angles using the screws, washers and nuts from the 'Endplates' section of the fittings kit. The bolts feed through from the channel angle and the nuts and washers are inside the endplate return flap.

Once the endplates are secured to their channel angles, they must be fitted to the stand-off angles and if possible to the structure. Holes have been pre-drilled in the back face to aid this if required. The endplates must be square and parallel to each other. Sometimes there will be a deflection caused by an uneven structure – this should be compensated for by using shims.

Fit drive-end endplate and axle

The supplied axle will have a large chain drive sprocket to one end, with a round plain shaft and the other end will have a keyed shaft for fitting to an anti-fall brake. Remove the pre-fitted curtain attachment screws and washers, and keep safe.

Slide the bearing on the drive end shaft so that 5 – 10mm of shaft is protruding and firmly tighten the grub screws – the drive shaft should be dimpled using a drill to allow firm location of the grub screws. The drive-end endplate can now be fitted to the bearing using the fittings from the 'Bearing Pack'.

With reference to the direction markings on the anti-fall back brake, slide on to the keyed non-drive end shaft.

Extreme care must be taken when installing the axle into position. We recommend the use of a mechanised work platform (scissor lift) at this stage using two persons.

Lift the axle up into position and attach the drive-end endplate to the channel angles using the fittings from the 'Endplate Pack'. The non-drive end brake can be secured to its shelf bracket on the endplate using fittings from the 'Bearing Pack'. Check the barrel is perfectly level, there may be a small amount of movement in the brake shelf bracket if required. Ensure the drive-end endplate is secured to the channel angles and if possible the structure.

Fit motor bracket and motor

The motor drive convertor has an input and output shaft. The output shaft needs to go through the hole on the motor mounting bracket and then have the drive sprocket slid on. The drive convertor can now be attached to the bracket using the fittings supplied in the 'Motor Pack'.

Fit this assembly to the relevant endplate with the fittings from the 'Motor Pack' slightly loose. Now align the motor drive sprocket with the larger drive sprocket on the axle and secure tightly using the grub screw. Fit the drive chain over both drive sprockets and secure with the supplied split link. The bracket should be pulled to tension the drive chain sufficient that there is minimal deflection of it when pressed.

The motor bracket has a pre-drilled lock off hole which must be used to secure it to the endplate. This will prevent any movement of the bracket to cause loosening of the chain tension. Fittings are supplied in the 'Motor Pack' for this purpose.

Now slide the motor onto the input shaft of the drive convertor and use the fittings supplied with the motor to secure it to the drive convertor.

Load curtain

The installer may find it easier to load the curtain prior to wiring the control unit by using the manual override haul chain. The motor travel limits can easily be set later in the installation process.

The override drive is engaged by pulling the Red toggle. Pull the haul chain until the axle has rotated to position the curtain attachment screw holes to between horizontal and vertical.

The curtain will be in bundles of approximately 35kg and clearly numbered from 1 (top) in order of attachment. The sections are rolled in their bundles so the top part is presented first. The top lath of the top section has pre-punched slots to enable easy attachment without having to move various attachment strips around.

Offer the top section up to the axle from the far side of the axle and pull over the axle to align the slots with the attachment holes. Loosely fit two screws and washers towards either end of the axle to

take the weight of the first curtain section, which can now be uncoiled and hung down. Now ensure the curtain section is aligned evenly between the channel angles. The rest of the screws and washers can now be attached and screwed in firmly, as well as the original loosely attached screws.

The remaining curtain sections can now be installed;

Single skin lath

The bottom lath of each section will be end-locked. There will be enough flexibility in the lath and end-lock to pull it away from the lath to enable the next section of curtain to be slid on. It may help if a medium sized flat bladed screwdriver is used to carefully prise the end-lock clear of the lath. If this is done, ensure that the end-lock is returned to its correct position.

This should be repeated until all of the curtain sections are attached. Depending on the situation, the installer may prefer to haul the curtain up on the haul chain after each section is attached. Otherwise, the installer can allow the curtain to hang all the way down and attach the last sections from the ground rather than from an access platform. Care should be taken if it is a windy day, as the curtain will act like a large sail.

Once the curtain has been fully installed, haul it up until the bottom lath is hanging about 100mm down from the underside of the endplates.

Insulated lath

The bottom lath of each section will have only one end-lock riveted in place, with the other end-lock loose and ready to be riveted in place. Slide the next section of curtain on from the open end and then rivet the loose end-lock into place with the supplied rivets. If sliding on from the open end isn't possible due to the nature of the structure, take the last lath off the upper section and slide it onto the top of the next section.

This should be repeated until all of the curtain sections are attached. Depending on the situation, the installer may prefer to haul the curtain up on the haul chain after each section is attached. Otherwise, the installer can allow the curtain to hang all the way down and attach the last sections from the ground rather than from an access platform. Care should be taken if it is a windy day, as the curtain will act like a large sail.

Once the curtain has been fully installed, haul it up until the bottom lath is hanging about 100mm down from the underside of the endplates.

Attach channels

Offer up the appropriate channels to the channel angles. With single skinned curtains, the channel may have welded on tab-stops which will need to be guided over the T-rail bottom lath. With insulated lath curtains there are no tab-stops, so it will be straightforward to position the guide channels.

Loosely fit all the channel screws and nuts to allow optimal positioning of channels before tightening.

Go to 'Commission shutter' section when this section is complete.

Commission shutter

This section refers to SeceuroDoor installations using a GfA motor. The information below is a summary of the booklet supplied with the GfA motor, should any further information be required. If your SeceuroDoor has been supplied with an operator other than a GfA, the instruction manual for that motor will be with the motor in its packaging.

Assuming the curtain has been hauled up on the override chain, disengage this mechanism by pulling the Green toggle. (For information; the Red toggle interlocks the motor so it cannot be operated using electric and must always be disengaged to restore push button control.)

General commissioning sequence

- Attach motor cable
- Attach Red/Green toggle extension cords
- Attach hand haul chain extension
- Mount hand haul chain keep
- Mount control unit
- Attach control unit cables
- Set motor limits
- Adjust operating mode & options

Attach motor cable

The motor cable has pre-wired plugs on each end. Remove the black housing on the underside of the motor. Plug in the appropriate connectors and feed the cable out of the housing, and reattach the housing.

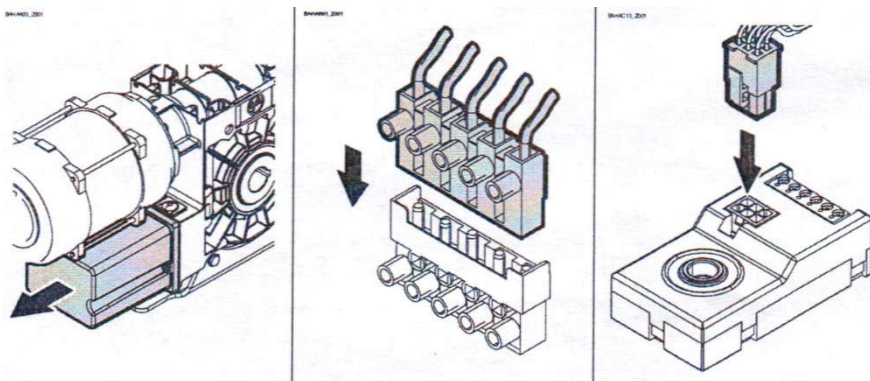

Feed the cable to where the control unit is to be installed. Ensure the cable is secured along its length by using appropriate containment or clips.

Attach Red/Green toggle extension cords

Extension cords are supplied and should be attached to the appropriate toggles to enable activation of the override mechanism by users from the ground. These can be simply looped and tied on and then the cord cut and adjusted to required length. Two cord guides are supplied and should be fitted against a flat surface to keep the cords away from the opening and any danger of snagging.

Attach hand haul chain extension

This will only be required if the shutter is taller than the standard hand haul chain. There is a special split link in the chain which does not require a tool. Split the chain and attach the extension, which also will have another special split link.

Mount hand haul chain keep

The chain keep must be fitted and used to keep the chain away from the opening and any danger of snagging. The end user may decide to use a padlock with this keep, so it is important to ensure the keep is accessible.

Mount control unit

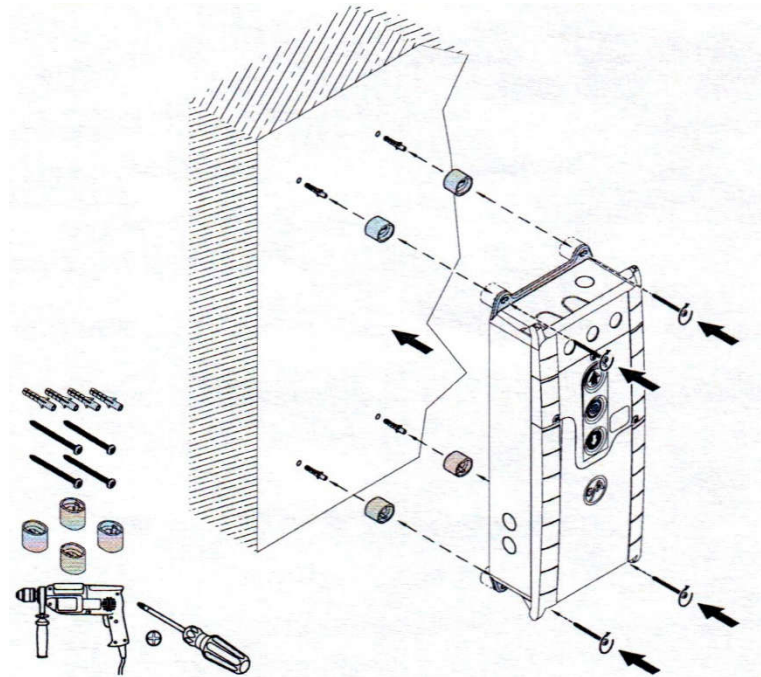

Attach control unit cables

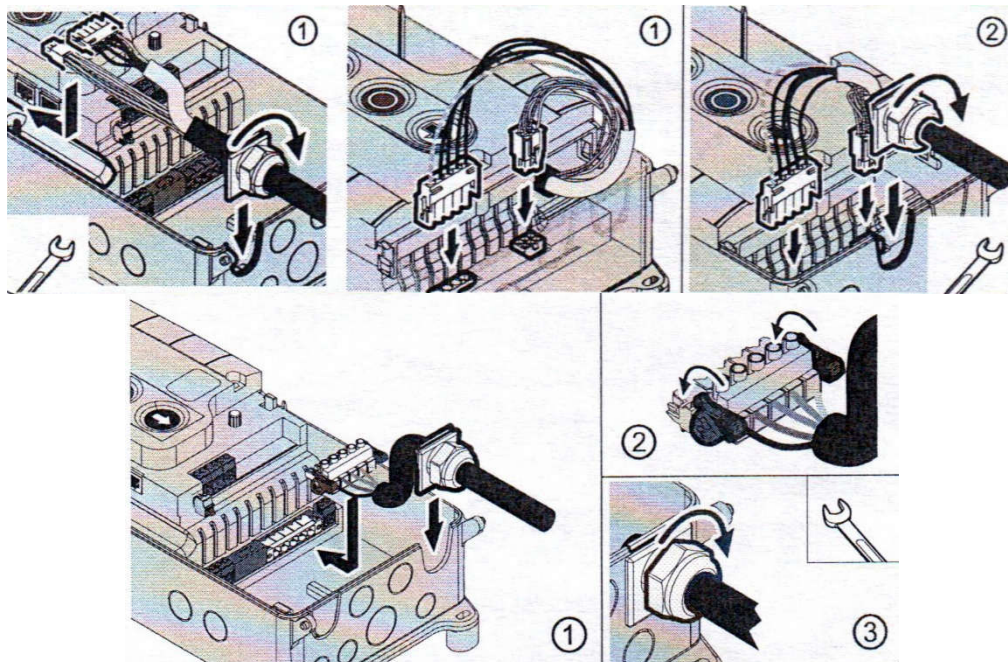

Set motor limits

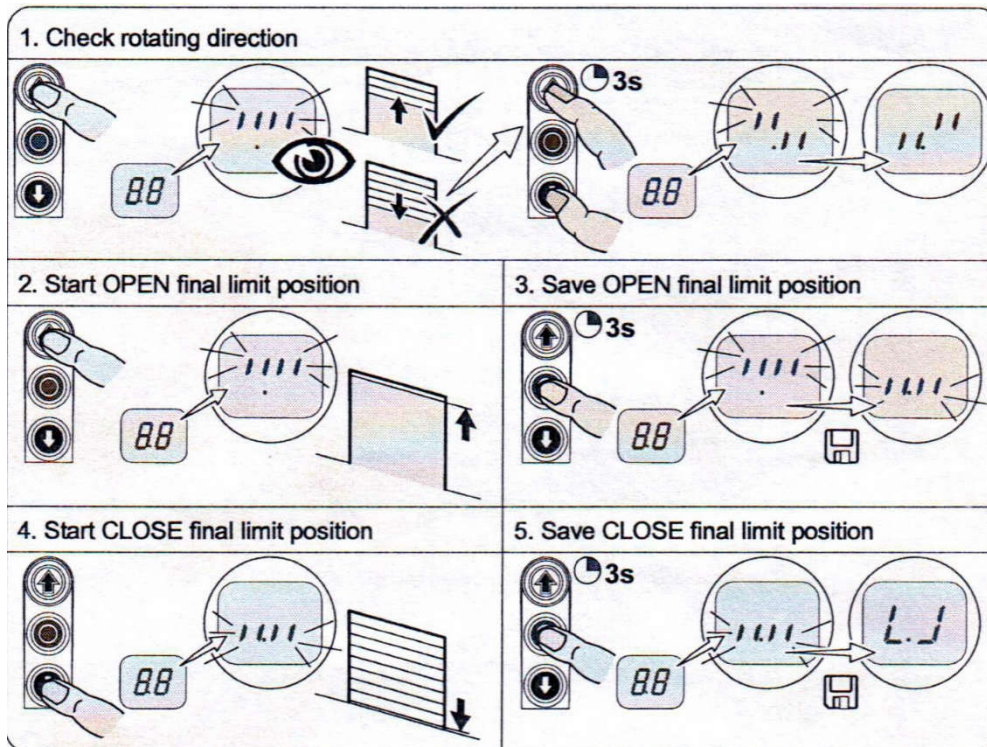

Adjust operating mode

1. Only program after rapid adjustment of final limit positions!

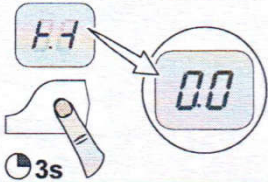

2. Select and confirm the menu

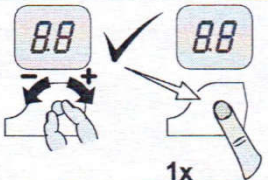

3.a) Set and store functions

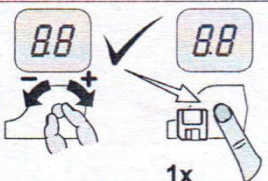



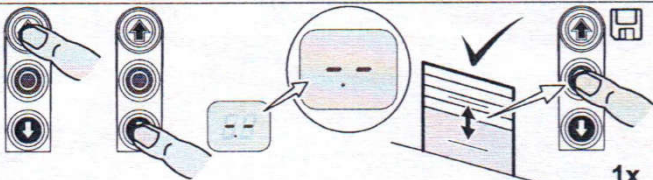

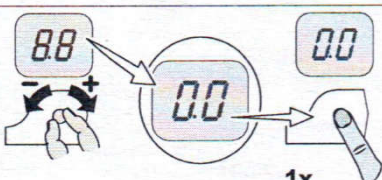

3.b) Set and save (DES) positions



4. Exit programming



Operating mode options

Operating mode		
01	Door operating mode	
	.1 OPEN Hold-to-run CLOSE Hold-to-run	
	.2 OPEN Self-hold CLOSE Hold-to-run	
	.5 Extended hold-to-run For NES: Set the S5 limit switch right before the Close position	
02	Output direction of rotation	
	.0 Maintain the output direction of rotation	
	.1 Change output direction of rotation	

Samson

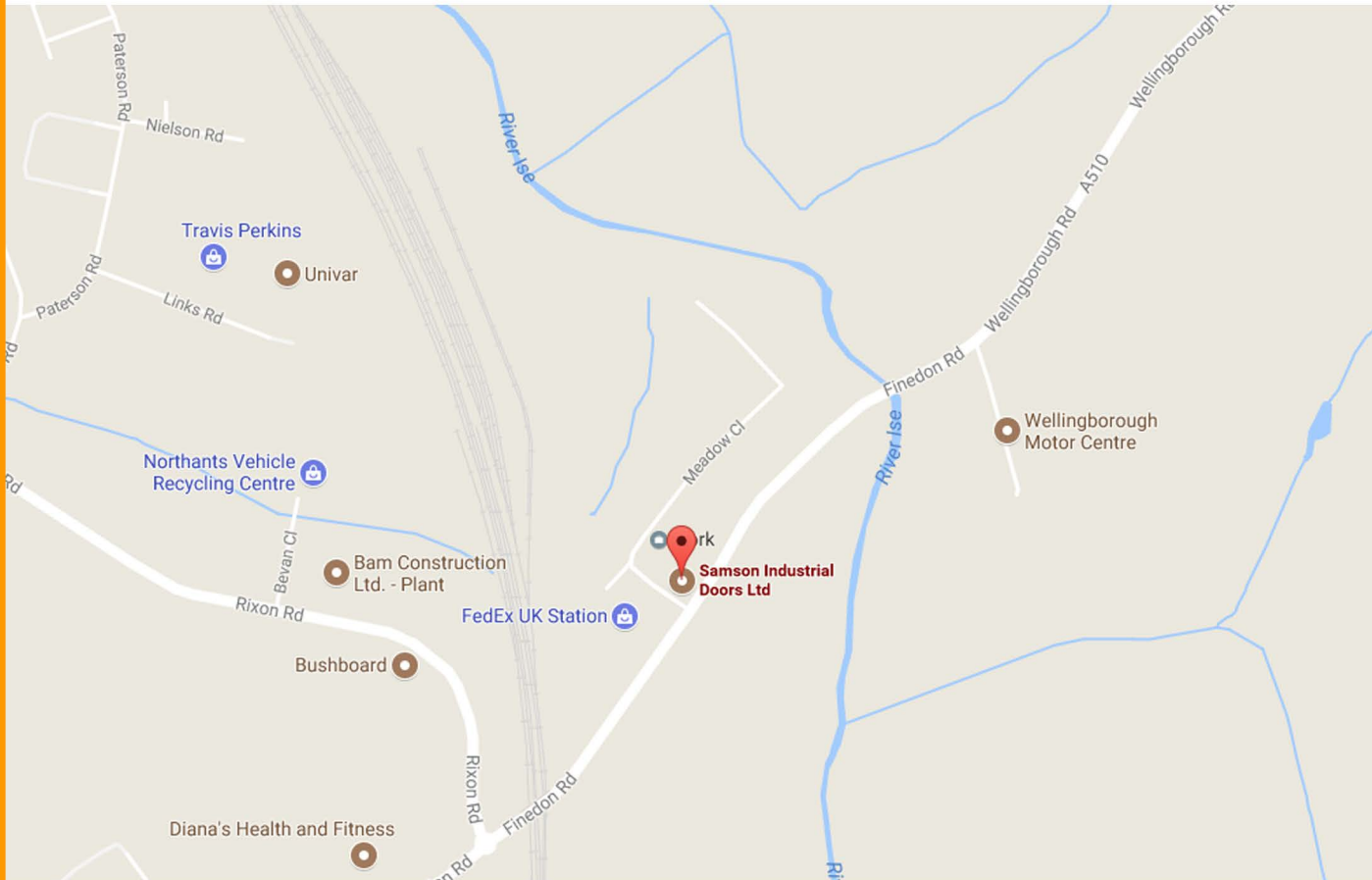

**6-8 MEADOW CLOSE
ISE VALLEY INDUSTRIAL ESTATE
FINEDON ROAD
WELLINGBOROUGH
NN8 4BH**

**EMAIL: ENQUIRIES@SAMSONDOORS.CO.UK
TELEPHONE: (01933) 274276
MON - FRI - 8.30AM - 5.30PM**