

Steel Hinged Door

Technical guide

January 2009



a member of the Sanwa Shutter family

Welcome to Novoferm

Novoferm is a member of the Sanwa Shutter family, the world's largest manufacturer of metal door systems and associated products.

Founded fifty years ago, now with annual sales in over 60 countries totalling more than £1.3 billion and with over 8,400 employees, Sanwa Shutter has become the world's number one company for metal door systems – providing everything from: garage doors, industrial doors, door and gate automation systems, shutters, shop-fronts and steel hinged doors for security, personal access and fire protection.

The Sanwa Shutter Family



SANWA HOLDINGS CORPORATION

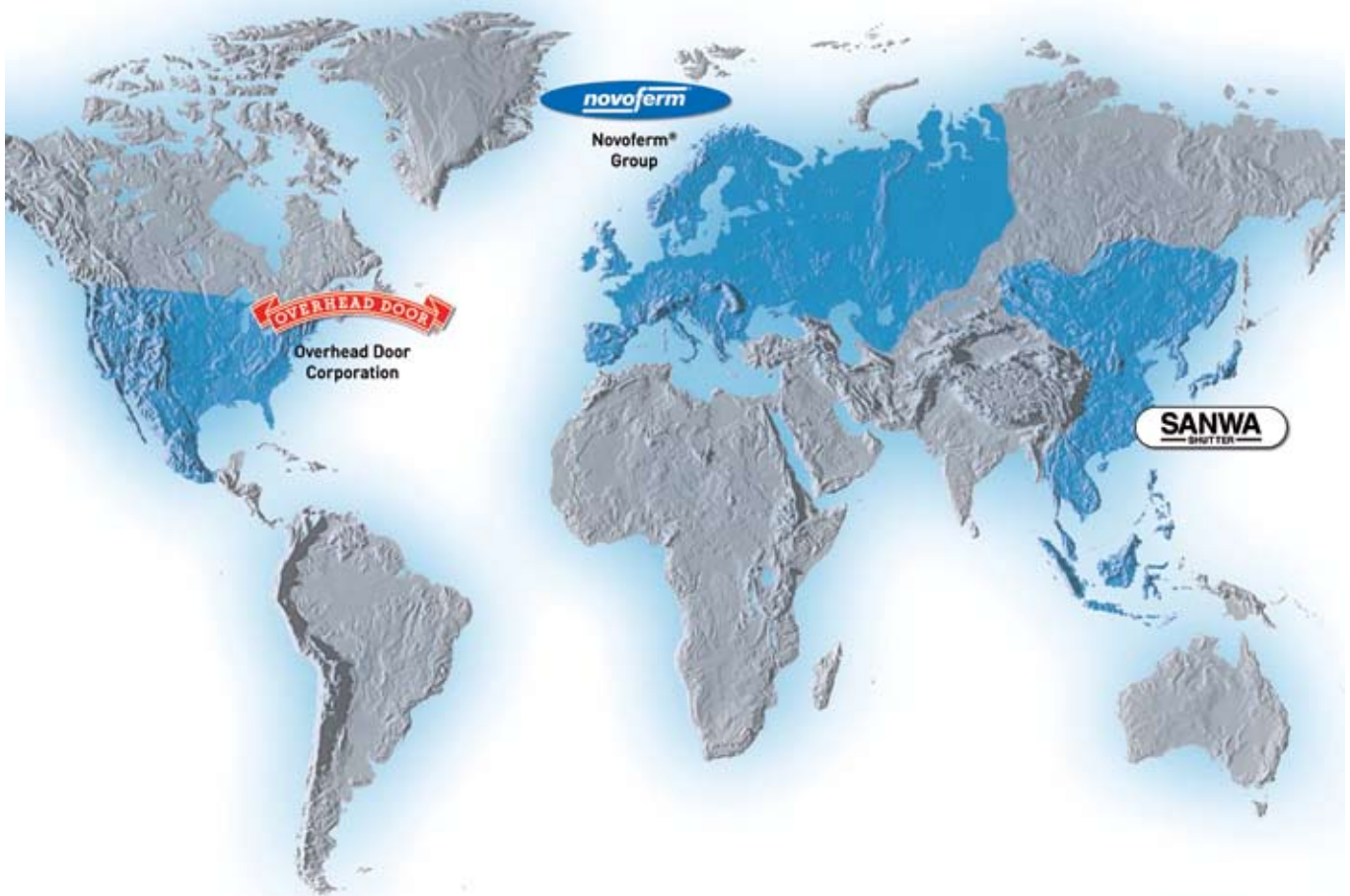



Steel Hinged Door Technical Guide

We are passionate about providing our customers with doors that guarantee safety, security and convenience – in their homes, workplaces, hospitals, schools, airports and shops.

**Discover door systems from Novoferm.
Your door... Our passion!**

Contents

An introduction to Novoferm	2
Frame profiles	4
Threshold options and door size configuration	5
Door panel arrangements, glazing and louvre options	6
Door handing selector	7
Escape hardware and furniture options	8
Lock case options	9
Standard hardware options	10
Technical specifications	11
Novoferm product family	12



Frame profiles

Novoferm can offer a standard range of metal door frames to suit most site conditions, complemented by an extensive range of 'bespoke' frame profiles. Manufactured from 1.5mm Zintec steel, with bolt-together corner frame assembly, our frame profiles are designed and constructed to meet customer demand and our stringent 'in-house' quality procedures.

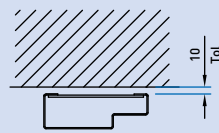

Header Frame Profile

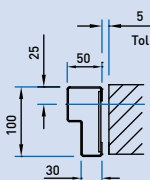

Standard Frame Profile

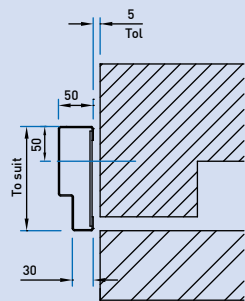

Optional Frame Profile

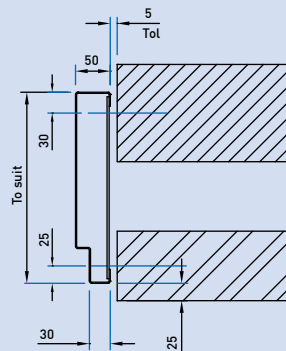

Optional Frame Profile

Door frames can be supplied with standard fixing positions or a wide variety of single and twin fixing positions to provide a secure and stable platform for the operation of the door and ensure long service life.





Threshold options

Low profile threshold bars are constructed from industrial grade aluminium and can be supplied with or without weather seals. Novoferm's range of threshold options provides suitability to most public and industrial applications, we can also offer a large range of DDA approved low profile thresholds to suit disabled access.

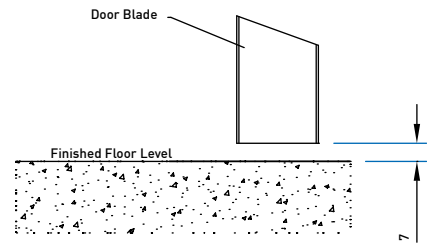

No Threshold

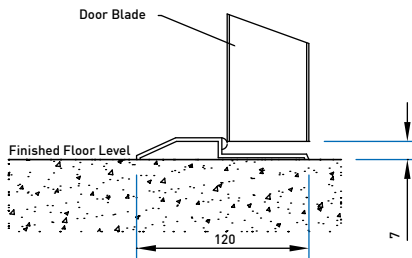

Low Profile Aluminium Threshold

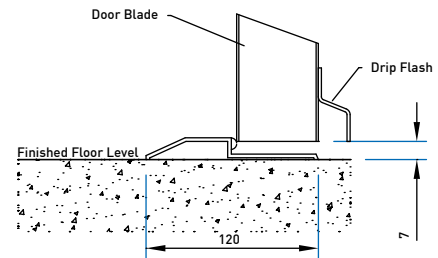

Low Profile Aluminium Threshold with Drip Flash



Size configuration

Novoferm provide steel doors to suit standard masonry and steel clear opening sizes, we can also offer 'made to measure' doors, purpose built to suit most applications. An extensive range of removable transom panels with louvre, glazing or solid infill are available.

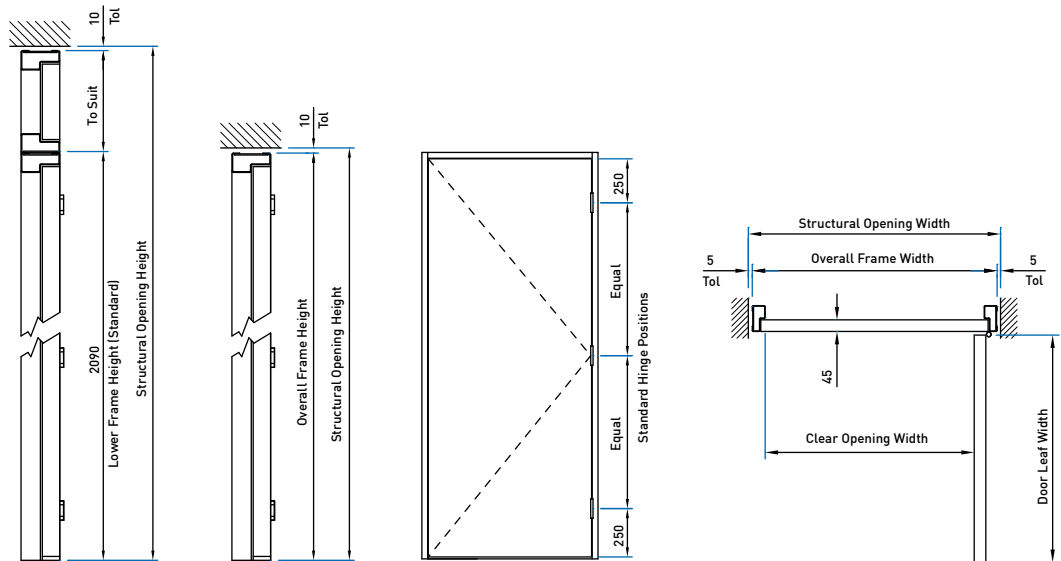

The minimum clear opening widths on escape routes are defined in the Building Regulation Approved Documents, which may limit the door clear opening sizes. Our 'bespoke' frame profiles with 'made to measure' doors cover most applications.

Door Panel arrangements

Novoferm's extensive range of 'made to measure' door panels, side panels and transom panel configurations suit both 'standard' and 'bespoke' applications.

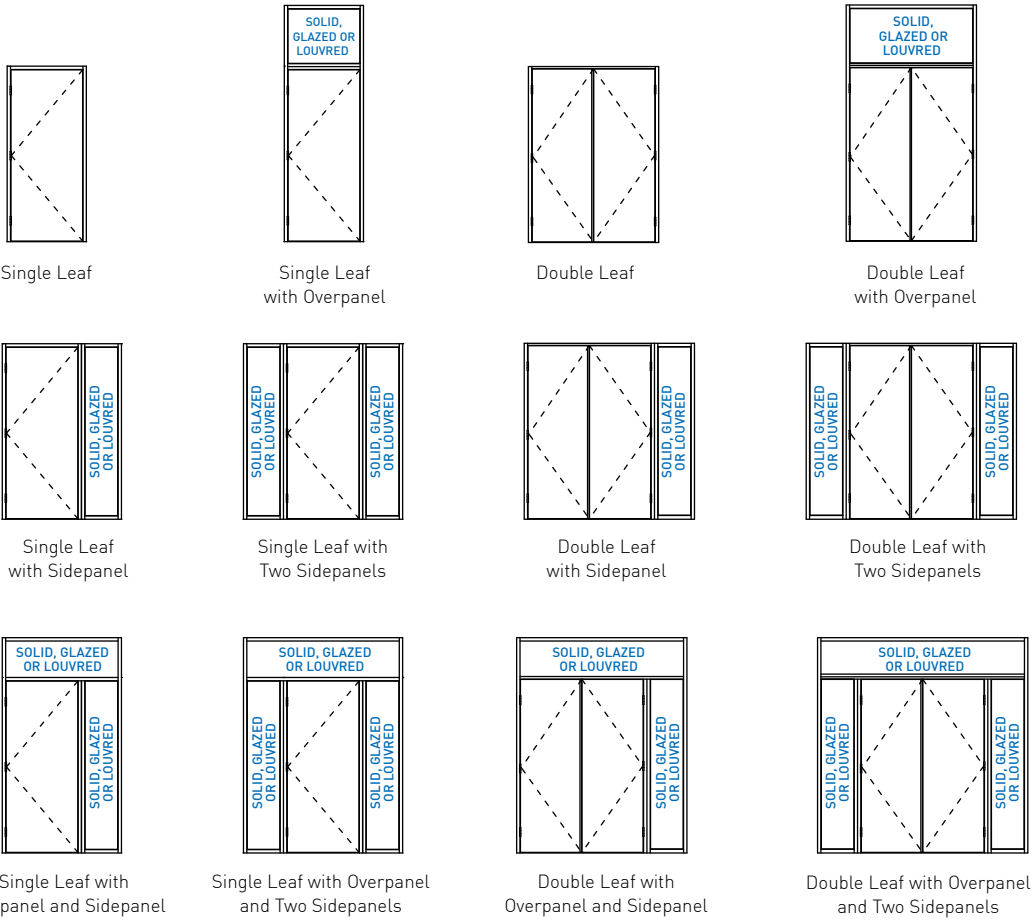

Glazing and Louvre options

We can offer a wide range of glazing, louvre and custom designs to meet your requirements.

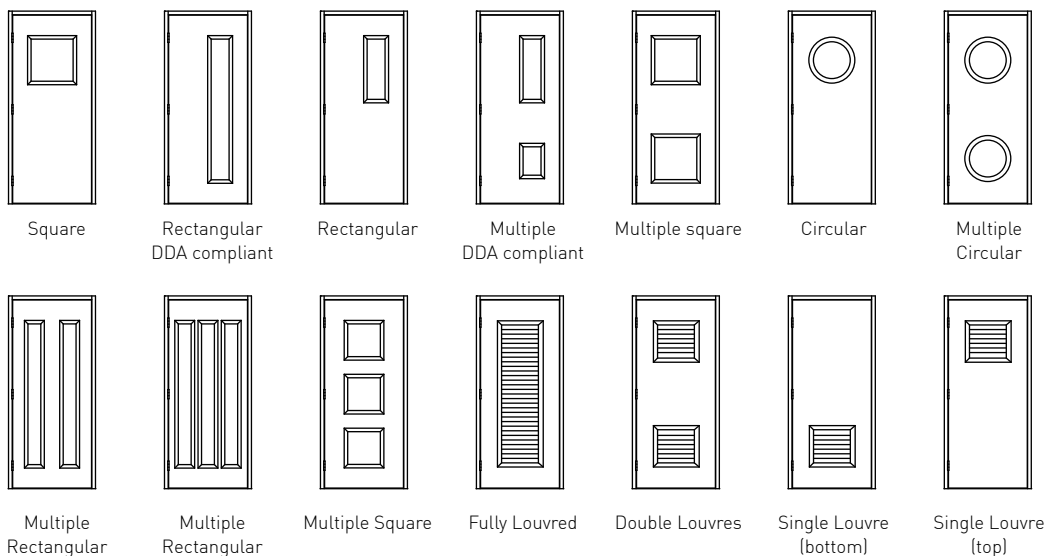



Door Handing Selector

Door handing options are available in left and right hand both inward and outward opening.

Single Blade Outward Opening

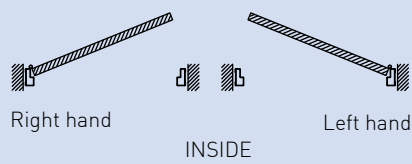

Single Blade Inward Opening

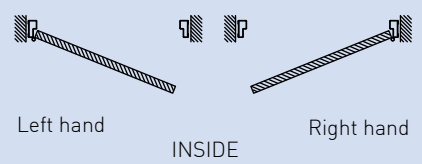

Double blade outward opening

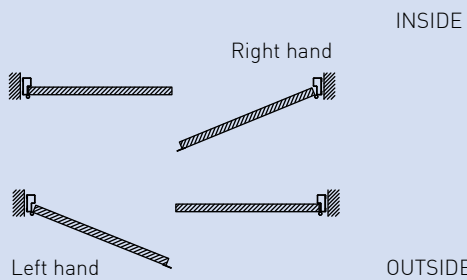

Double blade inward opening

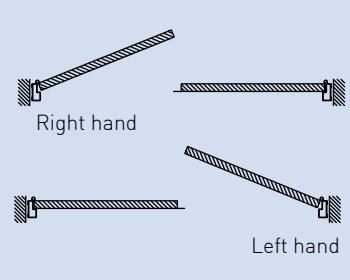



Escape Hardware Options



Two point panic bolt Two point locking at top and bottom with horizontal bar.



External locking attachment Euro-profile cylinder and turn knob.



Single point panic latch Single point latch with horizontal panic bar.



External locking attachment Euro-profile cylinder and lever handles.



Mortice nightlatch with panic bar actuator Morticed nightlatch operated by a horizontal panic bar.



Fire Exit signs We can supply a full range of exit signs and other mandatory signage.

Door Furniture



Pull handle 19mm dia x 225mm cts stainless steel pull handle on 75 x 300mm backing plate.



Push plate 75 x 300mm stainless steel plate.



Mortice lock components and terminology

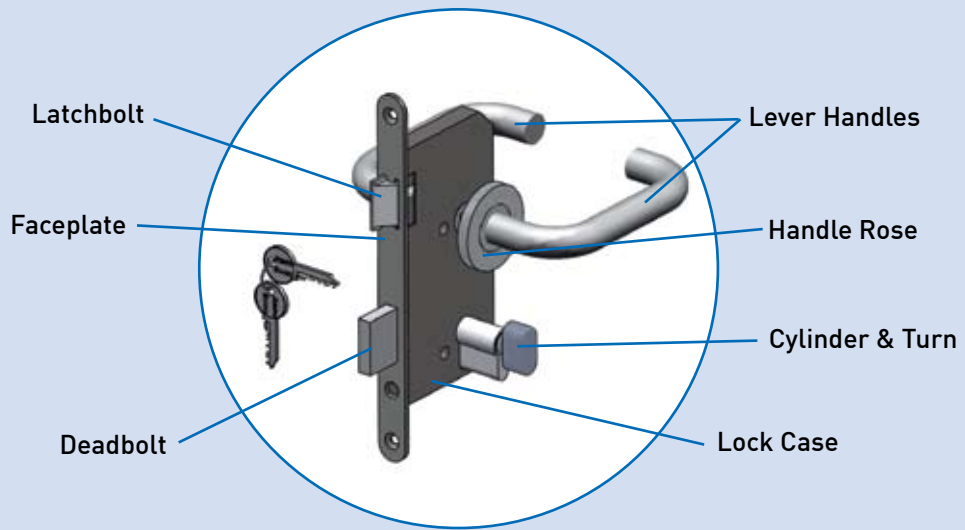

Mortice Lockcase Options



Exterior		Interior
Latchbolt retracted by lever handle or key.		Latchbolt retracted by lever handle or key.
Deadbolt operated by key		Deadbolt operated by thumbturn
SASHLOCK with Cylinder & Thumbturn		

Exterior		Interior
Latchbolt retracted by lever handle or key.		Latchbolt retracted by lever handle or key.
Deadbolt operated by key		Deadbolt operated by key
SASHLOCK with Double Cylinder		



Exterior		Interior
Deadbolt operated by key		Deadbolt operated by thumbturn
NB. Pull handles and/or Push Plates should be specified separately		
DEADLOCK with Cylinder & Thumbturn		

Exterior		Interior
Latchbolt retracted by lever handle or key.		Latchbolt retracted by lever handle or key.
Deadbolt operated by key		Deadbolt operated by key
DEADLOCK with Double Cylinder		



Exterior		Interior
Latchbolt retracted by Lever Handle		Latchbolt retracted by Lever Handle
NB. Door never locked		
LATCH only		



Exterior		Interior
Latchbolt retracted by key.		Latchbolt retracted by lever handle.
NIGHTLATCH with Single Cylinder		



Exterior		Interior
Latchbolt retracted by lever handle or key.		BOTH Latchbolt and Deadbolt retracted by lever handle.
Deadbolt operated by key.		Deadbolt operated by thumbturn.
ESCAPE SASHLOCK with Cylinder & Thumbturn		

Standard Hardware Set Options

Single Doors

Set 1 Pedestrian

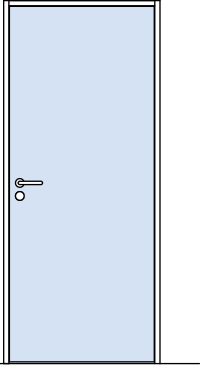

- Mortice Sashlock
- Cylinder & Turn
- Lever Set
- Escutcheons
- Frame Seals
- Security Bolts
- SS BB Hinges

Set 2 Fire Escape

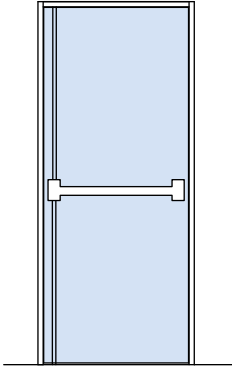

- Two point locking panic bar
- Frame Seals
- Security Bolts
- SS BB Hinges

Set 3 Fire Escape

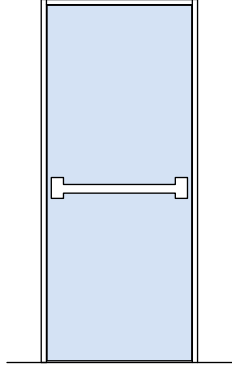

- Single point panic latch
- Frame Seals
- Security Bolts
- SS BB Hinges

Set 4 Personnel

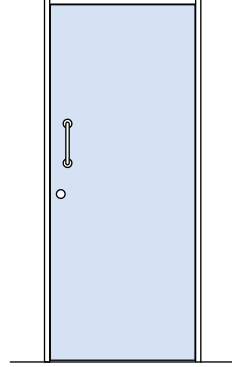

- Mortice Deadlock
- Cylinder & Turn
- Pull Handle
- Push Plate
- Escutcheons
- Frame Seals
- Security Bolts
- SS BB Hinges

Set 5 Security

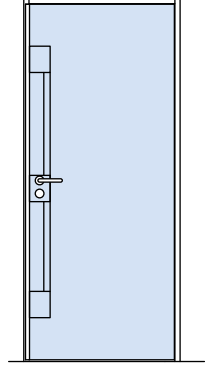

- Mortice 3 point locking
- Security Lip (leading edge)
- Cylinder & Turn
- Lever Set
- Escutcheons
- Frame Seals
- Security Bolts
- SS BB Hinges

Double Doors

Set 6 Pedestrian

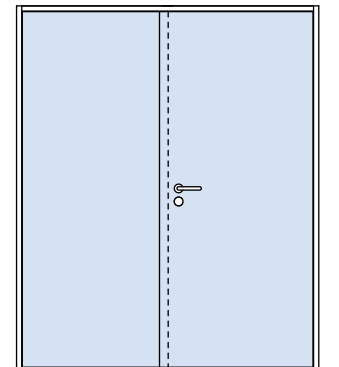

- Mortice Sashlock
- Cylinder & Turn
- Lever Set
- Flush Bolts
- Frame Seals
- Security Bolts
- SS BB Hinges

Set 7 Fire Escape

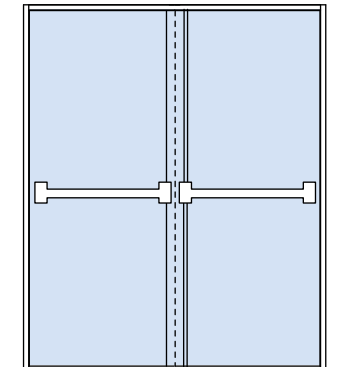

- Panic set
- Frame Seals
- Security Bolts
- SS BB Hinges

Set 8 Personnel

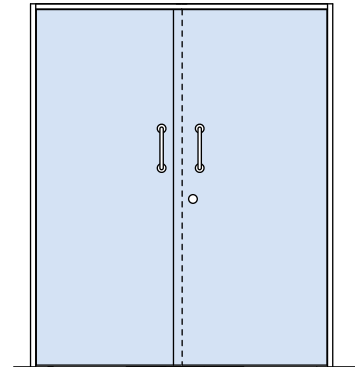

- Mortice Deadlock
- Pull Handles
- Push Plates
- Escutcheons
- Frame Seals
- Security Bolts
- SS BB Hinges

Available options

- Door closer • Friction stay • Kickplates • External locking attachment (panic set only) • Door viewer • Letter flap
- Integral security lipped edge (single doors) • Vision and louvre panels • Fire rating (certified door sets only)

Technical specifications



Finishes

- Grey Cellulose Primer
- Zinc Rich Powder Coated Grey Primer
- Polyester Powder Coated Top Coat (standard grade)
- Polyester Powder Coated Top Coat (marine grade)
- Full range of standard RAL and BS 4800 colours available
- Non-Standard colours are available on request



Leaf Construction

- Manufactured from two skins of 1.2mm (18swg) Zintec Steel
- 45mm thick door leaf
- Constructed to form a twin tray
- Bonded to a structural honeycomb infill as standard
- Capped top and bottom with 16 swg Zintec steel channels
- Supplied with flush leading edge as standard
- Integrated security lip as standard (double doors only)
- Option of an integrated security lip formed into the panel to single blade doors (not planted on)
- 'Floating' Hinge plates within the panel allow for on site adjustment

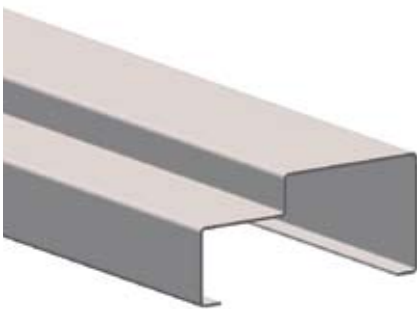

Frame Construction

- Manufactured from of 1.5mm (16swg) Zintec Steel
- Single rebate frame profile supplied as standard
- Various frame depths available from 85mm to 300mm
- Bolted top corner joints
- Single doors supplied fully built up and hung in frame
- Double doors supplied in knock-down form for on site assembly

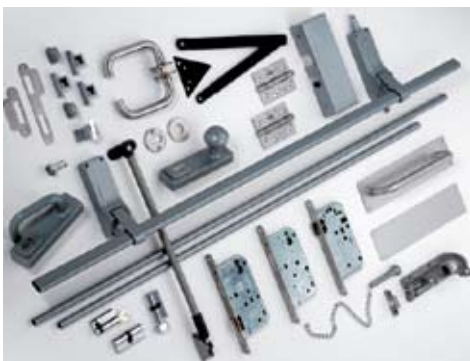

Hardware

- Standard range of quality hardware available specifically suited for steel personnel doors
- Bespoke and special arrangements to suit most applications
- Various finishes available
- All hardware factory fitted and tested in house to ensure full functionality and provide long service life



Other products available in the Novoferm industrial range...



Sectional Door
Thermo



Sectional Door
Prisma



Novospeed Alu



Ecospeed Aluminium



Strip Curtain



Swing Door



Speedroller



Dock Leveller



Dock Shelter



Dock Seal



Dock Pod

Your Novoferm Stockist

Samson Doors

www.samsondoors.co.uk

01933 274276