

Teckentrup Insulated Steel Fire Doors and Doorsets



**EMAIL: ENQUIRIES@SAMSONDOORS.CO.UK
TELEPHONE: (01933) 448850
MON - FRI 8:00AM - 5:00PM**

TECKENTRUP | PROFESSIONAL

THE PROFESSIONALS.

Professional fire and smoke protection doors



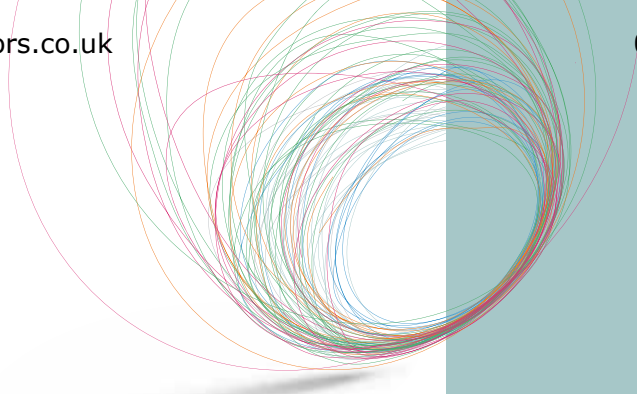

Performance promise and service standards

Design | Security | Service

Pages 04 - 13

Fire protection doors

Fire protection doors T30/T60/T90

T30-1-FSA "Teckentrup HT 8-D"

Pages 14 - 15

T30-1/2-FSA "Teckentrup 42"

Pages 16 - 17

Pages 18 - 19

62er modular system

Pages 20 - 21

T30-1/2-FSA "Teckentrup 62"

Pages 22 - 23

T30-1/2-FSA "Teckentrup 62 DF" (thick rebate)

Pages 24 - 25

T30-1/2-FSA "Teckentrup 72 ST" (flush)

Pages 26 - 27

T30-1/2-FSA "Teckentrup GL" (all-glass)

Pages 28 - 31

EI₂30-C5-S_a "Teckentrup 62"

Pages 32 - 33

EI₂30-C5-S_a "Teckentrup 62 DF" (thick rebate)

Pages 34 - 35

T60-1/2-FSA "Teckentrup 62"

Pages 36 - 37

EI₂60-C5-S_a „Teckentrup 62"

Pages 38 - 39

T90-1/2-FSA "Teckentrup 62"

Pages 40 - 41

T90-1/2-FSA "Teckentrup 62 DF" (thick rebate)

Pages 42 - 43

EI₂90-C5-S_a "Teckentrup 62"

Pages 44 - 45

EI₂90-C5-S_a "Teckentrup 62 DF" (thick rebate)

Pages 46 - 47

Smoke protection

Smoke protection doors

Pages 48 - 49

RS-1/2 „Teckentrup 62"

Pages 50 - 51

Design variety

Colours, stainless steel, glazings, handle-sets

Pages 52 - 56

Design profile FB

Pages 57 - 58

Safety aspects

Safety, accessories, door closer

Pages 59 - 69

Types of door frames

Pages 70 - 77

Technical data

Pages 78 - 79

MADE
IN
GERMANY

TECKENTRUP DOOR SOLUTIONS

Whether it's development, production or distribution, whether it's about the entire whole or about a small detail, for us, everything revolves around the decisive question: **WHAT IS THE SOLUTION FOR YOU?**

Because we are the specialist for fire protection, smoke protection, sound insulation and security doors, for industrial sectional doors, rolling shutters, folding doors, sliding doors and garage doors.

And we are **"Made in Germany"**. For more than 80 years, we have developed and produced our products exclusively in Germany. More than 900 employees at our locations in Verl and Großzöberitz create our high-quality products for you. All processes, from supply to production to commissioning and delivery, are based on the DIN EN ISO 9001 quality management system.

DESIGN

SECURITY

SERVICE

Teckentrup produces more than doors and gates: Teckentrup delivers solutions. Which is why we have applied three new standards to our company and our products which meet your needs: Design. Security. Service.

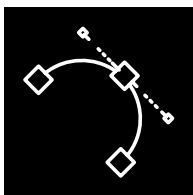
**Design:** We link functionality and aesthetics.

Because good design represents innovative technology that meets the needs of the user. Our products are opening new worlds and offer many individual design options. With us, designers and engineers work hand-in-hand from the beginning. So that intelligent ideas are just as convincing at the second glance and sophisticated designs prove themselves day after day.

**Security:** We link systems to protection.

Our doors meet the highest requirements and are certified accordingly. We are happy to advise you on necessary standards and develop comprehensive needs-oriented safety approaches in order to protect people and valuables.

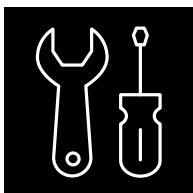
**Service:** We link speed to reliability.

Proximity, clear structures, everything from one source. This is the service advantage of Teckentrup. Because, from product development to installation, from the committed support of our expert advisers to professional servicing: we will be there for you right away. We are happy to make the time.



BUILDING EXPERTISE FROM ONE SOURCE

Large construction projects are faced with enormous cost pressure. This is why all of our products are embedded in an approach for process optimisation. We count on holistic service – from planning to installation to operating our folding doors. We can support you with consultation and planning services, we provide just-in-time deliveries if required, we place great emphasis on easy installation and we are also there to help you at any time during the construction phase by providing solutions at short notice. Therefore, you can rest assured that you receive the right solution for all of your property's requirements.

OUR SERVICES FOR YOU

Secure clear efficiency advantages for yourself in every project phase:

- Comprehensive property and project advising for each of your projects
- Standardised technological platform with sophisticated installation materials
- Tender documents and technical drawings to develop your tender

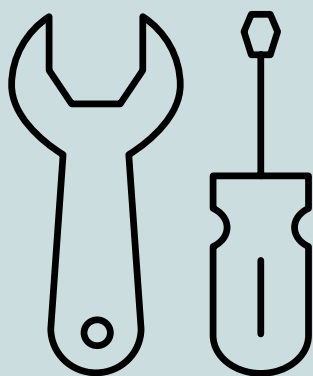

More information at www.teckentrup.co.uk

PROFESSIONAL PRODUCTS IN EVERY DETAIL

You will know the situation as a professional project manager: Whether the project turns out to be a great success often depends on minute details. Got to know that you can rely on our comprehensively designed door solutions. For instance, when it comes to accessories, components and supplemental modules.

In serial production at Teckentrup: Extra advise ex works: Whether it is door handles, lock and escape route technology, hinges and security bolts, door closers or electronic attachments - our employees are happy to support you select and configure the optimal components at any time. It goes without saying that this also applies for the selection of the colours, surfaces and glazing. The result is a comprehensive systematic solution for your project in which all pieces perfectly fit.





COMPREHENSIVE SERVICE

We provide custom solutions and comprehensive service to our customers, from project planning to installation to operating our doors. Take a look for yourself.



ELBPHILHARMONIE HAMBURG

In a concert hall with an auditorium capacity of up to 2.100 spectators the escape routes for instance require time-consuming planning. Depending on their place of action they are one-leaf or two-leaf versions, as T30 or T90, some with and some without smoke protection. Where special sound insulation was required, special fastening material had to be used. Approximately one sixth of the doors are opening automatically and around 40 percent of the doors are connected to the access control system, to the burglar alarm system or the central smoke extraction system. To keep escape routes for people with special needs clear, some fire protection doors are mandatory to open automatically. Those solutions are reason for our products being named „door solutions“. In total there are 15 different frame versions with identical visual appearance.





DATA CENTRES

When people think of data centres, the first things that come to mind are telecommunication providers and cloud operators such as Amazon or Google, who rely on large computing capacities. However, data centres are of great importance for the overall future viability of commercial enterprises and society as a whole.

What hardly anyone thinks about is the physical infrastructure of these data complexes. In this highly sensitive environment, high demands are also placed on doors and their manufacturers. In recent years, Teckentrup has developed in-depth product know-how and a wide range of services and consultation services in this field.

Doors with resistance class RC 2- RC 4 (in accordance with EN 1627) are absolutely essential in order to provide maximum protection for vulnerable areas in the buildings. For the door manufacturer, this means that in some areas, several characteristics in one door must be combined: security, fire, pressure, panic etc. come together here. The construction of the individual server rooms (cages) represents a major technical challenge. Fire protection in elevated installation positions (so-called raised floors) in combination with lightweight construction stud walls must be provided.



EUROPAPARK RUST

Germany's largest theme park is located in the border triangle of Germany, France and Switzerland. On 95 hectares, Europa-Park delights almost six million visitors a year with 13 roller coasters and more than 100 attractions and shows in 15 European themed areas.

Fire protection that inspires visually: At the Europa-Park in Rust, the fire protection doors have none of the clunky appearance of earlier fire protection elements, on the contrary: they blend harmoniously into the sophisticated design of the theme park. It was always a question of finding the optimum solution for the sometimes very different requirements. In the Europa Park, T30-1/2 FSA 62, dw 42, dw 62 multi-purpose doors, among others, are used - depending on the fire protection requirements.

The doors blend in with the scenery. In view of the gigantic dimensions of the park, visitors usually pass unnoticed through a number of doors of various sizes and designs during their stay. The doors often have to fulfil fire protection requirements. Teckentrup has contributed around 250 doors to date. The latest additions to the theme park, the Rulantica water world and the Krønasår hotel, received around 150 doors.





PS.SPEICHER EINBECK

The former granary from 1898 stood empty for a long time until the "Kultur-stiftung Kornhaus" had it restored in 2009. The 6,500 m² of the granary had to be modernised without losing its historical charm. The result are rooms with a combination of cool, elegant steel and warm, cosy wooden elements for the approx. 300 exhibits of the 130-year history of two-, three- and four-wheelers.

Teckentrup is responsible for the safety concept of the "PS.Speicher".

Special steel doors with burglary, fire and in some cases also smoke protection are used. Like for example the double-leaf steel door T90-2 "Teckentrup 62" steel door, which protects against fire, smoke and burglary. This door is sound-insulating and serves as a transition from the bistro to the showroom.

With the patina and the fittings, it fits in perfectly with the ambience, as if it had always belonged to the granary. All single- and double-leaf T90 multifunctional doors are certified according to DIN 4102 (fire-resistant), and all monitoring and locking systems (e.g. the magnetic contacts) of the doors are double.

TECKENTRUP FIRE PROTECTION DOORS

In the event of fire, the primary goal is to protect people from the flames and prevent further spread of the fire.

Good to know that you can also benefit from our decades of experience in this area, too. Our fire protection doors, in addition to comprehensive licences in accordance with DIN 4102 (verified in accordance with EN 1634-1), also hold certifications in accordance with EN 16034 for the European market. Our fire resistant doors thereby guarantee the life cycles required by the legislator and also meet the highest requirements in terms of aesthetics and burglary protection.



Benefits that convince

- Improved fire protection
- Tested as per EN 1634-1
- With CE-label
- EI₂ 30-C5-S_a + EI₂ 60-C5-S_a
EI₂ 90-C5-S_a
- Door leaf flush without protruding edges
- Faster installation and easier to close
- Height adjustable
- More safety, design and convenience

Uses:

- Production plants
- Office buildings
- Hospitals / clinics
- Public facilities
- Large residential structures
- Large garages and schools
- Cultural buildings and cinemas
- Blocks of flats and detaches houses



T30/T60/T90 according to
EN 1634-1/DIN 4102





FIRE-RESISTANT STEEL DOOR

T30-1-FSA "TECKENTRUP „HT 8-D“

- SINGLE LEAF
- THIN REBATE
- NEW: WITH EXPOSED MASONRY INSTALLATION
- FOR LEFT OR RIGHT HAND OPERATION
- FOR INDOOR USE

Size range

Modular dimension: (as flap):

Width: 750 – 1000 mm

Height: 800 – 1250 mm

Modular dimension, 1-leaf:

Width: 750 – 1125 mm

Height: 875 – 2125 mm

Installation in

Modular dimension, 1-leaf:

- Masonry, min. 115 mm
- Concrete, min. 100 mm

Door leaf

- Double-skinned
- Door 4-leaf rebated (thin rebate)
- Door leaf thickness: 42 mm
- Panel thickness: 0.9 mm
- Security bolt: at least 1

Surface

Door leaf and frame galvanised, powder-coated and primed; grey white like RAL 9002

Frame

- Corner page, 4-leaf, 2.0 mm thick with circumferential seal (sound-insulated)
- Frame attached with exposed masonry installation
- Frame with floor recess (standard)

Special frame equipment

Counter frame or circumferential frame

Special equipment

- Prepared for escutcheon hardware
- Top door closer as per EN 1154
- Locks (panic locks)
- Electric door openers
- Lock control (bolt contact) installed



Fire-resistant
as per EN 1634-1/
DIN 4102



Smoke-proof
as per EN 1634-3/
DIN 18095¹⁾



Sound-insulated
as per EN 20140/
EN 717-1 up to
RW 39 dB¹⁾



Burglary-resistant
according to
EN 1627-WK2²⁾

SONDERAUSSTELLUNG

KLEINST- UND KLEINWAGEN



FIRE-RESISTANT STEEL DOOR

T30-1/2-FSA "TECKENTRUP 42"

- 1- AND 2-LEAFS
- THIN REBATE
- FLUSH DOOR LEAF WITHOUT HINGE STAMPING
- SERIAL FOR EXPOSED MASONRY INSTALLATION
- FOR INDOOR USE

Size range

Modular dimension, 1-leaf:

Width: 625 – 1125 mm

Height: 1750 – 2250 mm

Modular dimension, 2-leafs:

Width: 1375 – 2250 mm

Height: 1750 – 2250 mm

Installation in

- Masonry, min. 115 mm
- Concrete, min. 100 mm
- Lightweight construction stud wall²⁾, min. 88 mm
- Autoclaved aerated concrete, min. 115 mm
- Clad steel and wooden supports F60

Door leaf

- Double-skinned, 3-leaf rebated (thin rebate)
- Door leaf thickness: 42 mm
- Panel thickness: 1.0 mm
- Security bolt: at least 1

Surface

Door leaf and frame galvanised, powder-coated and primed; grey white like RAL 9002

Frame

- Corner frame, 2.0 mm thick with 3-leaf seal
- Frame attached with exposed masonry installation

Special frame equipment

Counter frame, U frame or block frame

Special equipment

- Prepared for escutcheon hardware
- Top door closer as per EN 1154
- Locks (panic locks)
- Electric door openers
- Arresting systems
- Bottom seals



Fire-resistant
as per EN 1634-1/
DIN 4102



Smoke-proof
as per EN 1634-3/
DIN 18095¹⁾

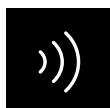

Sound-insulated
as per EN 20140/
EN 717-1 up to
RW 37 dB¹⁾



Burglary-resistant
only 1-leaf
according to
EN 1627 WK2²⁾



SMART AND MODULAR

The modular system of the
Teckentrup 62er doors.

Fives steps to your objective

Our 62er modular system has 400,000 combinations for you. However, what is more important is that all of your needs are met: Your dream door. The path there is very simple. First, you define the application area and the associated functionality, such as fire protection. Then we move on to the checklist: How is the rebate to be structured? What type of wall are we working with? What frame best fits your spatial situation? And last but not least: What special equipment is desired?

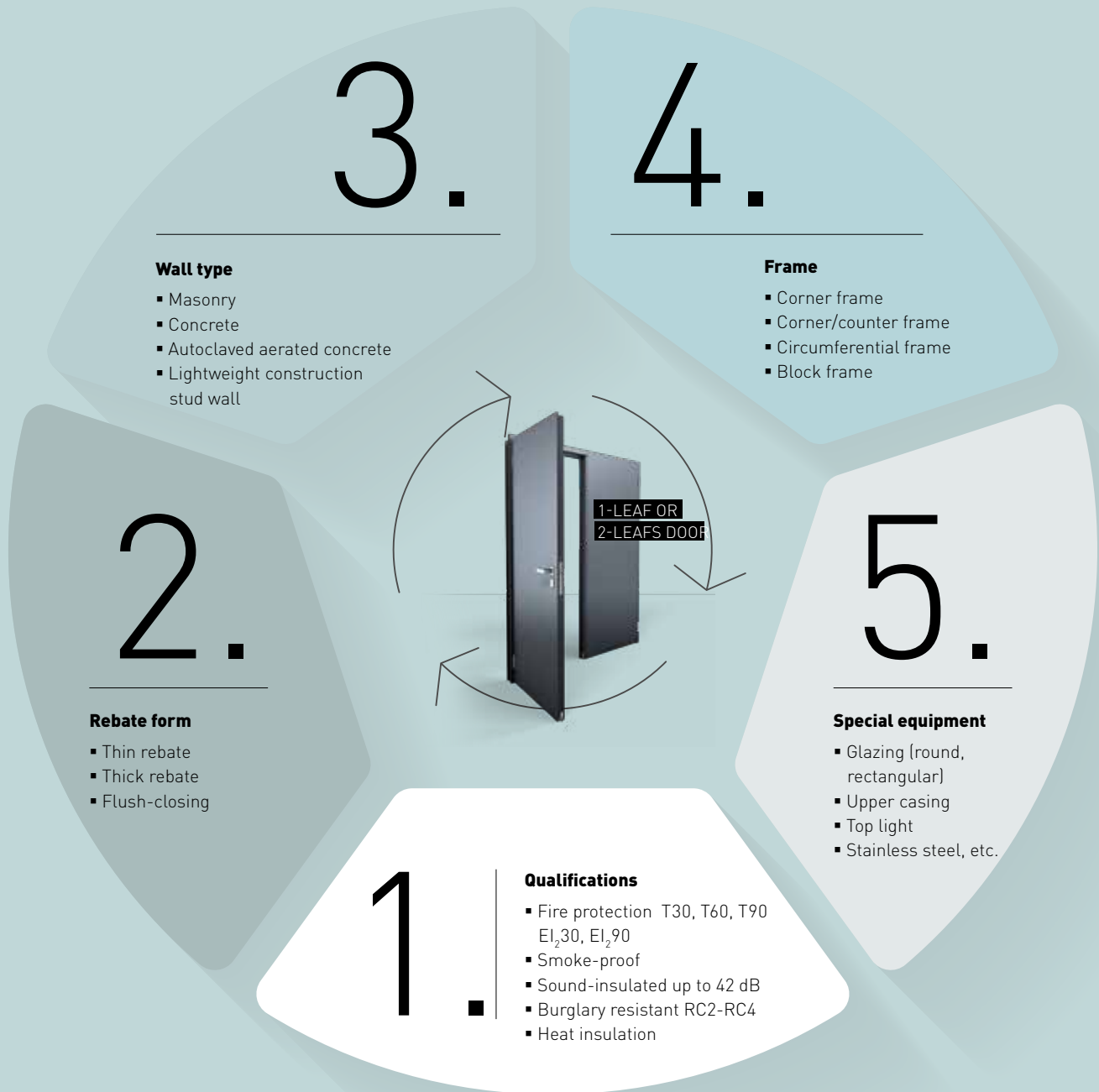

As flexible as your needs: With our modular system, you configure step by step the doors desired for your property. In harmony with the architecture, for the purpose of use and in line with the technical circumstances on site. **Now also for outside use!**



FIRE-RESISTANT STEEL CAP/STEEL DOOR

T30-1/2-FSA "TECKENTRUP 62"

- 1- AND 2-LEAFS
- THIN REBATE
- OPTIONALLY WITH GLAZING AND UPPER CASING
- ALSO IN STAINLESS STEEL
- FOR INDOOR USE

Size range
Modular dimension, 1-leaf:
Width: 500 – 1500 mm
Height: 500 – 4000 mm
Modular dimension, 2-leaves:
Width: 1375 – 3000 mm
Height: 1750 – 4000 mm
With upper casing/top light: 4600 mm

Installation in
<ul style="list-style-type: none"> ▪ Masonry, min. 115 mm ▪ Concrete, min. 100 mm ▪ Lightweight construction stud wall²⁾, min. 88 mm ▪ Autoclaved aerated concrete, min. 115 mm ▪ Clad steel and wooden supports F60

Door leaf
<ul style="list-style-type: none"> ▪ Double-skinned (thin rebate) ▪ Door 3-leaf rebated ▪ Hatch 4-leaf rebated ▪ Door leaf thickness: 62 mm ▪ Panel thickness: 1.0 mm or 1.5 mm ▪ Security bolt: per leaf at least 1

Surface
Door leaf and frame galvanised, powder-coated and primed; grey white like RAL 9002

Frame
<ul style="list-style-type: none"> ▪ Corner frame, 1.5 / 2.0 mm thick ▪ Cap 4-leaf, door 3-leaf with circumferential seal ▪ Frame attached with exposed masonry installation

Special frame equipment
Counter frame, U frame or block frame

Glazing
<ul style="list-style-type: none"> ▪ Fire protection glass F30 ▪ With aluminium glass retainer strips, steel glass retainer strip galvanised and primed, grey white like RAL 9002 ▪ Max. glazing dimensions 904 x 2150 mm ▪ Round glazing Ø 300, 400, 500

Special equipment
<ul style="list-style-type: none"> ▪ Prepared for escutcheon hardware ▪ Top door closer as per EN 1154 ▪ Locks (panic locks) ▪ Electric door openers ▪ Lock control (bolt contact) installed ▪ Swing door drives ▪ Optional with design profile FB



Fire-resistant
as per EN 1634-1/
DIN 4102



Smoke-proof
as per EN 1634-3/
DIN 18095¹⁾



Sound-insulated
as per EN ISO 10140/
EN ISO 717-1 up to
RW 44 dB¹⁾

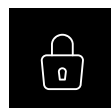

Burglary-resistant
according to
DIN EN 1627
RC 2 – RC 4¹⁾



ATEX
Directive
2014/34/EU¹⁾

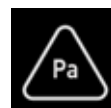

Pressure resistance
as per EN 12210¹⁾



FIRE-RESISTANT STEEL DOOR

T30-1/2-FSA "TECKENTRUP 62 DF" (THICK REBATE)

- 1- AND 2-LEAFS
- THICK REBATE
- OPTIONALLY WITH GLAZING AND UPPER CASING
- ALSO IN STAINLESS STEEL
- FOR INDOOR USE

Size range

Modular dimension, 1-leaf:

Width: 625 – 1500 mm

Height: 1750 – 3500 mm

Modular dimension, 2-leaves:

Width: 1375 – 3000 mm

Height: 1750 – 3500 mm

With upper casing height: 3 750 mm

Installation in

- Masonry, min. 115 mm
- Concrete, min. 100 mm
- Lightweight construction stud wall²⁾, min. 88 mm
- Autoclaved aerated concrete, min. 115 mm
- Clad steel and wooden supports F60

Door leaf

- Double-skinned, rebated on 3 sides with thick rebate
- Door leaf thickness: 62 mm
- Panel thickness: 1.0 mm or 1.5 mm
- Security bolt: per leaf at least 1

Surface

Door leaf and frame galvanised and primed; grey white like RAL 9002

Frame

- Corner frame, 1.5 / 2.0 mm
- 3-leaf with circumferential seal and lower floor bracket
- Frame attached with exposed masonry installation

Special frame equipment

Counter frame, U frame or block frame

Glazing

- Fire protection glass F30
- Glazing field rectangular with Aluminium glass retaining strips
- Max. glazing dimensions 1162 x 1912 mm
- Round glazing Ø 300, 400, 500

Special glazing equipment

- Steel glass retainer strips with additional aluminium cover strips, round glazing
- Glass retainer strips made from stainless steel

Special equipment

- Prepared for escutcheon hardware
- Top door closer as per EN 1154
- Locks (panic locks)
- Secured drive deadlocks
- Swing door drives
- Optional with design profile FB



Fire-resistant
as per EN 1634-1/
DIN 4102



Smoke-proof
as per EN 1634-3/
DIN 18095¹⁾

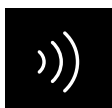

Sound-insulated
as per EN ISO 10140/
EN ISO 717-1 up to
RW 42 dB¹⁾

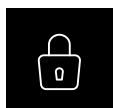

Burglary-resistant
according to
DIN EN 1627
RC 2 – RC 3¹⁾



ATEX
Directive
2014/34/EU¹⁾



FLUSH-CLOSING FIRE-RESISTANT STEEL DOOR

T30-1/2-FSA "TECKENTRUP 72 ST"

- 1- AND 2-LEAFS
- DOOR AND FRAME REBATE-FREE AND FLUSH WITH THE WALL SURFACE
- OPTIONALLY WITH GLAZING

Size range
Modular dimension, 1-leaf:
Width: 625 – 1350 mm
Height: 1750 – 2500 mm
Modular dimension, 2-leaves:
Width: 1375 – 2500 mm
Height: 1750 – 2500 mm

Installation in
<ul style="list-style-type: none"> ▪ Masonry, min. 115 mm ▪ Concrete, min. 100 mm ▪ Lightweight construction stud wall²⁾, min. 88 mm ▪ Autoclaved aerated concrete, min. 115 mm ▪ Clad steel and wooden supports F60

Door leaf
<ul style="list-style-type: none"> ▪ Double-skinned, flush-closing ▪ Door leaf thickness: 72 mm ▪ Panel thickness: 1.0 mm ▪ Security bolt: per leaf min. 1

Surface
Door leaf and frame galvanised, powder-coated and primed; grey white like RAL 9002

Frame
<ul style="list-style-type: none"> ▪ Corner frame, 1.5 mm thick with 3-leaf circumferential seal ▪ Frame attached with exposed masonry installation

Special frame equipment
Counter frame, U frame or block frame

Glazing
<ul style="list-style-type: none"> ▪ Fire protection glass F30 ▪ With steel glass retaining strips ▪ Max. glazing dimensions 1162 x 1912 mm ▪ Round glazing <ul style="list-style-type: none"> Ø 300 Ø 400, 500 mm (stainless steel glass retaining strips) ▪ Special glazing (stainless steel glass retaining strips)

Special equipment
<ul style="list-style-type: none"> ▪ Prepared for escutcheon hardware ▪ Top door closer as per EN 1154 ▪ Locks (panic locks) ▪ Electric door openers ▪ Swing door drives ▪ Bottom seals can be retrofitted



Fire-resistant
as per EN 1634-1/
DIN 4102



Smoke-proof
as per EN 1634-3/
DIN 18095¹⁾

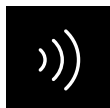

Sound-insulated
as per EN 20140/
EN 717-1 up to
RW 42 dB¹⁾



Burglary-resistant
according to
DIN EN 1627,
RC 2¹⁾



TECKENTRUP

ALL GLASS DOORS

Transparency opens up spaces, creates broad views and communication, benefits flat hierarchies, brings brightness and lightness to contemporary architecture. We add a crucial plus point to these clear benefits:

100% FIRE PROTECTION

Maximum transparency with 100% fire protection? Teckentrup also offers you that. Our all glass door T30 is ex works fire-resistant in accordance with EN 1634-1/DIN 4102 and smoke-tight according to DIN 1634-3/DIN 18095. That makes its lean, reserved design with the elegant hardware made from stainless steel all the more fascinating.



FIRE-RESISTANT ALL-GLASS DOOR

T30-1/2-FSA "TECKENTRUP GL"

- 1- AND 2-LEAFS
- FRAMELESS FIRE PROTECTION DOOR FOR MAXIMUM TRANSPARENCY
- HIGH-QUALITY, ELEGANT APPEARANCE
- 1-LEAF FULL GLASS DOOR ALSO SOUND-INSULATED

Size range

Modular dimension, 1-leaf:

Width: 625 – 1250 mm

Height: 1750 – 2500 mm

Modular dimension, 2-leaves:

Width: 1375 – 2500 mm

Height: 1750 – 2500 mm

Installation in

Modular dimension, 1-leaf:

- Masonry, min. 115 mm
- Concrete, min. 100 mm
- Lightweight construction stud wall²⁾, min. 100 mm
- Autoclaved aerated concrete, min. 115 mm

Modular dimension, 2-leaves:

- Masonry, min. 175 mm
- Concrete, min. 140 mm
- Autoclaved aerated concrete, min. 175 mm

Door leaf

Door leaf thickness: 27 mm

Surface

- Fitting covers stainless steel, 1.4301 240er corn polished
- Frame galvanised and powdercoated primed, traffic white like RAL 9016

Frame

- Corner frame, 1.5 mm thick with 3-leaf seal and lower floor bracket
- Frame attached with exposed masonry installation

Special frame equipment

- Counter frame, U frame or block frame
- Block frame type 4.1 and type 4.2

Special equipment

- Film coating possible on the glass
- Door drive
- Anti-panic function
- Frame in RAL as desired or in stainless steel



Fire-resistant
as per EN 1634-1/
DIN 4102



Smoke-proof
as per EN 1634-3/
DIN 18095¹⁾



Sound-insulated
as per EN 20140/
EN 717-1 up to
RW 34 dB¹⁾ [only 1-leaf]



FIRE PROTECTION OUTSIDE DOOR

EI₂30-C5-S_a "TECKENTRUP 62"

- 1- AND 2-LEAFS
- THIN REBATE
- LICENSED FOR OUTDOOR APPLICATION
- CE MARKING ACCORDING TO EN 16034 / 14351-1
- DIFFERENTIAL CLIMATE BEHAVIOUR 2(d)/2(e)

Size range

Modular dimension, 1-leaf: (as flap):

Width: 500 – 1250 mm

Height: 500 – 1749 mm

Modular dimension, 1-leaf:

Width: 625 – 1250 mm

Height: 1750 – 2500 mm*

Modular dimension, 2-leaves:

Width: 1375 – 2500 mm

Height: 1750 – 2500 mm*

*With upper casing height: 3500 mm
Upper casing with/without glass

Door sizes larger than the above require technical clarification.

Installation in

Modular dimension, 1-leaf:

- Masonry, min. 115 mm
- Concrete, min. 100 mm
- Autoclaved aerated concrete, min 115 mm

Modular dimension, 2-leaves:

- Masonry, min. 115 mm
- Concrete, min. 100 mm
- Autoclaved aerated concrete, min 115 mm

Door leaf

- Double-skinned, 3-sided rebated
- Door leaf thickness: 62 mm
- Sheet thickness: 1.0 mm or 1.5 mm also available in stainless steel 1.0 mm
- Security bolt: per leaf min. 1
- Flush door leaf without hinge stamping
- Door closer (Building inside)
- Bottom seal

Surface

- Door leaf and frame galvanised and powder coated, grey-white similar to RAL 9002
- Also in stainless steel

Frame

- Corner frame, 1.5 mm thick with 3-leaf circumferential seal
- Frame attached with exposed masonry installation

Special frame equipment

Counter frame, surrounding frame or block frame

Special equipment

- Upper rain guard
- Bottom weather board
- Glazing (EI30)
- Electric strike
- Closing control (bolt contact) installed
- Opening detector (Reed contact) installed
- RAL of your choice
- Electromechanical blocking device
- and much more



Fire-resistant
as per EN 1634-1



Smoke-proof
as per EN 1634-3¹⁾



Sound-insulated
as per EN ISO 10140/
EN ISO 717-1 up to
RW 42 dB¹⁾

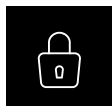

Burglary-resistant
according to
IN EN 1627,
RC 2 - RC 4¹⁾



ATEX
Directive
2014/34/EU¹⁾

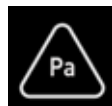

Pressure resistance
as per EN 12210¹⁾



FIRE-PROOF STEEL DOOR

EI₂ 30-C5-S_a "TECKENTRUP 62" (THICK REBATE)

- 1- AND 2-LEAFS
- THICK REBATE
- LICENSED FOR OUTDOOR APPLICATION
- CE MARKING ACCORDING TO EN 16034 / 14351-1
- DIFFERENTIAL CLIMATE BEHAVIOUR 2(d)/2(e)

Size range

Modular dimension, 1-leaf: (as flap):

Width: 500 – 1250 mm

Height: 500 – 1749 mm

Modular dimension, 1-leaf:

Width: 500 – 1250 mm

Height: 500 – 2500 mm*

Modular dimension, 2-leaves:

Width: 1375 – 2500 mm

Height: 1750 – 2500 mm*

*With upper casing height: 3500 mm
Upper casing with/without glass

Door sizes larger than the above require technical clarification.

Installation in

Modular dimension, 1-leaf:

- Masonry, min. 115 mm
- Concrete, min. 100 mm
- Autoclaved aerated concrete, min 115 mm

Modular dimension, 2-leaves:

- Masonry, min. 115 mm
- Concrete, min. 100 mm
- Autoclaved aerated concrete, min 115 mm

Door leaf

- Double-skinned, 3-sided rebated
- Door leaf thickness: 62 mm
- Sheet thickness: 1.0 mm or 1.5 mm also available in stainless steel 1.0 mm
- Security bolt: per leaf min. 1
- Flush door leaf without hinge stamping
- Door closer (Building inside)
- Bottom seal

Surface

- Door leaf and frame galvanised and powder coated, grey-white similar to RAL 9002
- Also in stainless steel

Frame

- Corner frame, 1.5 mm thick with 3-leaf circumferential seal
- Frame attached with exposed masonry installation

Special frame equipment

Counter frame, surrounding frame or block frame

Special equipment

- Upper rain guard
- Bottom weather board
- Glazing (EI30)
- Electric strike
- Closing control (bolt contact) installed
- Opening detector (Reed contact) installed
- RAL of your choice
- Electromechanical blocking device
- and much more



Fire-resistant
as per EN 1634-1



Smoke-proof
as per EN 1634-3¹⁾



Sound-insulated
as per EN ISO 10140/
EN ISO 717-1 up to
RW 42 dB¹⁾



Burglary-resistant
according to
DIN EN 1627,
RC 2- RC 3¹⁾



ATEX
Directive
2014/34/EU¹⁾



HIGHLY FIRE-RESISTANT STEEL DOOR

T60-1/2-FSA "TECKENTRUP 62"

- 1- AND 2-LEAFS
- THIN REBATE
- ALSO IN STAINLESS STEEL
- OPTIONALLY WITH GLAZING
- FOR INDOOR USE

Size range
Modular dimension, 1-leaf: (as flap):
Width: 625 – 1250 mm
Height: 650 – 1749 mm
Modular dimension, 1-leaf:
Width: 625 – 1250 mm
Height: 650 – 2500 mm
Modular dimension, 2-leaves:
Width: 1375 – 2500 mm
Height: 1750 – 2500 mm

Installation in
<ul style="list-style-type: none"> ▪ Masonry, min. 115 mm ▪ Concrete, min. 100 mm ▪ Lightweight construction stud wall²⁾, min. 100 mm ▪ Autoclaved aerated concrete, min. 150 mm ▪ Clad F90 steel beams

Door leaf
<ul style="list-style-type: none"> ▪ Double-leaf ▪ Door 3-leaf rebated ▪ Hatch 4-leaf rebated ▪ Door leaf thickness: 62 mm ▪ Panel thickness: 1.0 mm ▪ Security bolt: per leaf 2

Surface
Door leaf and frame galvanised, powder-coated and primed; grey white like RAL 9002

Frame
<ul style="list-style-type: none"> ▪ Corner frame 1.5 mm thick with 3-leaf seal and lower floor bracket ▪ Frame attached with exposed masonry installation

Special frame equipment
Counter frame, U frame or block frame

Glazing
<ul style="list-style-type: none"> ▪ Fire protection glass F60 ▪ Glazing field rectangular with Aluminium glass retaining strips ▪ Max. glazing dimensions 741 x 1658 mm ▪ Round glazing Ø 300, 400, 500 ▪ Steel glass retainer strip galvanised and primed; grey white like RAL 9002

Special equipment
1-leaf:
<ul style="list-style-type: none"> ▪ Prepared for escutcheon hardware ▪ Locks: ▪ Top door closer as per EN 1154 ▪ For doors with glazing with OTS ▪ Secured drive deadlocks ▪ Electric door openers ▪ Lock control (bolt contact) installed ▪ Opening detector (Reed contact) installed ▪ Swing door drives ▪ Arresting systems



Highly fire-resistant
as per EN 1634-1/
EN 1634-2



Smoke-proof
as per EN 1634-3/
DIN 18095¹⁾



Sound-insulated
as per EN 20140/
EN 717-1 up to
RW 33 dB¹⁾



Burglary-resistant
according to
DIN EN 1627,
RC 2 - RC 3¹⁾



ATEX
Directive
2014/34/EU¹⁾

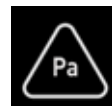

Pressure resistance
as per EN 12210¹⁾



FIRE-PROOF STEEL DOOR

EI₂ 60-C5-S_a "TECKENTRUP 62" (THICK REBATE)

- 1- AND 2-LEAFS
- THIN REBATE
- LICENSED FOR OUTDOOR APPLICATION
- CE MARKING ACCORDING TO EN 16034 / 14351-1
- DIFFERENTIAL CLIMATE BEHAVIOUR 2(d)/2(e)

Size range

Modular dimension, 1-leaf: (as flap):

Width: 625 – 1350 mm

Height: 650 – 1749 mm

Modular dimension, 1-leaf:

Width: 625 – 1350 mm

Height: 1350 – 2500 mm

Modular dimension, 2-leaves:

Width: 1375 – 2500 mm

Height: 1750 – 2500 mm

Door sizes larger than the above require technical clarification.

Installation in

Modular dimension, 1-leaf:

- Masonry, min. 115 mm
- Concrete, min. 140 mm
- Autoclaved aerated concrete, min 150 mm

Modular dimension, 2-leaves:

- Masonry, min. 115 mm
- Concrete, min. 140 mm
- Autoclaved aerated concrete, min 150 mm

Door leaf

- Double-skinned, 3-sided rebated
- Door leaf thickness: 62 mm
- Sheet thickness: 1.0 mm
- Security bolt: per leaf min. 1
- Flush door leaf without hinge stamping
- Door closer (Building inside)
- Bottom seal

Surface

- Door leaf and frame galvanised and powder coated, grey-white similar to RAL 9002

Frame

- Corner frame, 1.5 mm thick with 3-leaf circumferential seal
- Frame attached with exposed masonry installation

Special frame equipment

Counter frame, surrounding frame or block frame

Special equipment

- Upper rain guard
- Bottom weather board
- Glazing (EI60)
- Electric strike
- Closing control (bolt contact) installed
- Opening detector (Reed contact) installed
- RAL of your choice
- Electromechanical blocking device
- and much more



Fire-resistant
as per EN 1634-1



Smoke-proof
as per EN 1634-3¹⁾



Sound-insulated
as per EN ISO 10140/
EN ISO 717-1 up to
RW 33 dB¹⁾



Burglary-resistant
according to
DIN EN 1627,
RC 2 - RC 3¹⁾



ATEX
Directive
2014/34/EU¹⁾

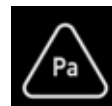

Pressure resistance
as per EN 12210¹⁾



bezahlen Sie Ihr
Ticket an der
Rezeption.
Please pay your
park ticket
at the reception.

FIRE-PROOF STEEL DOOR / FIRE-PROOF HATCH

T90-1/2-FSA "TECKENTRUP 62"

- 1-AND 2-LEAFS
- THIN REBATE
- ALSO IN STAINLESS STEEL
- OPTIONALLY WITH GLAZING
- FOR INDOOR USE

Size range
Modular dimension, 1-leaf: (as flap):
Width: 500 – 1250 mm
Height: 500 – 1749 mm
Modular dimension, 1-leaf:
Width: 500 – 1500 mm
Height: 500 – 3000 mm
Modular dimension, 2-leaves:
Width: 1375 – 3000 mm
Height: 1750 – 3000 mm
With upper casing height: 4000 mm

Installation in
<ul style="list-style-type: none"> ▪ Masonry, min. 175 mm ▪ Concrete, min. 140 mm ▪ Lightweight construction stud wall²⁾, min. 84 mm ▪ Autoclaved aerated concrete, min. 175 mm ▪ Clad F90 steel beams ▪ Permitted for installation at greater heights (> 500 mm; with limited equipment variance)

Door leaf
<ul style="list-style-type: none"> ▪ Double-skinned ▪ Door 3-leaf rebated (thin rebate) ▪ Hatch 4-leaf rebated ▪ Door leaf thickness: 62 mm ▪ Panel thickness: 1.0 mm – 1.5 mm ▪ Security bolts: at least 1 per leaf

Surface
Door leaf and frame galvanised, powder-coated and primed; grey white like RAL 9002

Frame
<ul style="list-style-type: none"> ▪ Corner frame, 1.5 mm thick ▪ Cap 4-leaf, door 3-leaf with circumferential seal and lower floor bracket ▪ Frame attached with exposed masonry installation

Special frame equipment
Counter frame, U frame or block frame

Glazing
<ul style="list-style-type: none"> ▪ Fire protection glass F90 ▪ With aluminium glass retaining strips ▪ Max. glazing dimensions 1000 x 2263 mm ▪ Round glazing Ø 300, 400, 500 mm with steel glass retainer strip galvanised and primed; grey white like RAL 9002

Special glazing equipment
<ul style="list-style-type: none"> ▪ Steel glass retainer strips with additional aluminium covering strips ▪ Round glazing retainer strips in stainless steel

Special equipment
<ul style="list-style-type: none"> ▪ Prepared for escutcheon hardware ▪ Top door closer as per EN 1154 ▪ Locks (panic locks) ▪ Swing door drives ▪ Bottom seals can be retrofitted ▪ Optional with design profile FB



Fire-proof
as per EN 1634-1/
DIN 4102



Smoke-proof
as per EN 1634-3/
DIN 18095¹⁾

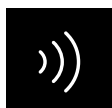

Sound-insulated
as per EN ISO 10140/
EN ISO 717-1 up to
RW 42 dB¹⁾

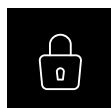

Burglary-resistant
according to
IN EN 1627,
RC 2 – RC 4¹⁾



ATEX
Directive
2014/34/EU¹⁾

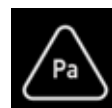

Pressure resistance
as per EN 12210¹⁾



FIRE-PROOF STEEL DOOR

T90-1/2-FSA "TECKENTRUP 62 DF" (THICK REBATE)

- 1- AND 2-LEAFS
- THICK REBATE
- ALSO IN STAINLESS STEEL
- FOR INDOOR USE

Size range

Modular dimension, 1-leaf:

Width: 625 – 1500 mm

Height: 1750 – 3500 mm³⁾

Modular dimension, 2-leaves:

Width: 1375 – 3250 mm⁴⁾

Height: 1750 – 3500 mm³⁾

Installation in

- Masonry, min. 175 mm
- Concrete, min. 140 mm
- Lightweight construction stud wall²⁾, min. 100 mm
- Autoclaved aerated concrete, min. 200 mm

Door leaf

- Double-skinned, rebated on 3 sides with thick rebate
- Door leaf thickness: 62 mm
- Panel thickness: 1.0 mm/1.5 mm also available in stainless steel 1.0 mm
- Security bolt: per leaf at least 2

Surface

- Door leaf and frame galvanised and powder coated, grey-white similar to RAL 9002
- Also in stainless steel

Frame

- Corner frame, 2.0 mm (3.0 mm) thick with 3-leaf seal and lower floor bracket
- Frame attached with exposed masonry installation

Special frame equipment

Counter frame, U frame or block frame

Glazing

- Fire protection glass F90
- With aluminium glass retaining strips
- Max. glazing dimensions 1000 x 2263 mm
- Round glazing Ø 300, 400, 500

Special glazing equipment

- Steel glass retainer strips galvanised and primed
- Round glazing - glass retainer strips made from stainless steel

Special equipment

- Top door closer as per EN 1154
- Locks (panic locks)
- Panic bar handle
- Swing door drives
- RAL of your choice
- Electric strike
- Closing control (bolt contact) installed
- Opening detector (Reed contact) installed
- Electromechanical blocking device
- and much more



Fire-proof
as per EN 1634-1/
DIN 4102



Smoke-proof
as per
EN 1634-3¹⁾

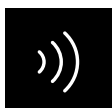

Sound-insulated
as per EN ISO 10140/
EN ISO 717-1 up to
RW 41 dB¹⁾

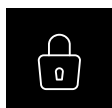

Burglary-resistant
according to
EN 1627,
RC 2 – RC 3¹⁾



ATEX
Directive
2014/34/EU¹⁾



FIRE PROTECTION OUTSIDE DOOR

EI₂90-C5-S_a "TECKENTRUP 62"

- 1- AND 2-LEAFS
- THIN REBATE
- LICENSED FOR OUTDOOR APPLICATION
- CE MARKING ACCORDING TO EN 16034 / 14351-1
- DIFFERENTIAL CLIMATE BEHAVIOUR 2(d)/2(e)

Size range

Modular dimension, 1-leaf: (as flap):

Width: 500 – 1250 mm

Height: 500 – 1749 mm

Modular dimension, 1-leaf:

Width: 625 – 1250 mm

Height: 1750 – 2500 mm*

Modular dimension, 2-leaves:

Width: 1375 – 2500 mm

Height: 1750 – 2500 mm*

*With upper casing height: 3500 mm
Upper casing with/without glass

Door sizes larger than the above require technical clarification.

Installation in

Modular dimension, 1-leaf:

- Masonry, min. 175 mm
- Concrete, min. 140 mm
- Autoclaved aerated concrete, min 175 mm

Modular dimension, 2-leaves:

- Masonry, min. 175 mm
- Concrete, min. 140 mm
- Autoclaved aerated concrete, min 175 mm

Door leaf

- Double-skinned, 3-sided rebated
- Door leaf thickness: 62 mm
- Sheet thickness: 1.0 mm or 1.5 mm also available in stainless steel 1.0 mm
- Security bolt: per leaf min. 1
- Flush door leaf without hinge stamping
- Door closer (Building inside)
- Bottom seal

Surface

- Door leaf and frame galvanised and powder coated, grey-white similar to RAL 9002
- Also in stainless steel

Frame

- Corner frame, 1.5 mm thick with 3-leaf circumferential seal
- Frame attached with exposed masonry installation

Special frame equipment

Counter frame, surrounding frame or block frame

Special equipment

- Upper rain guard
- Bottom weather board
- Glazing (EI90)
- Electric strike
- Closing control (bolt contact) installed
- Opening detector (Reed contact) installed
- RAL of your choice
- Electromechanical blocking device
- and much more



Fire-proof
as per EN 1634-1



Smoke-proof
as per EN 1634-3¹⁾

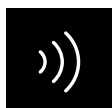

Sound-insulated
as per EN ISO 10140/
EN ISO 717-1 up to
RW 42 dB¹⁾

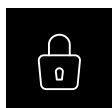

Burglary-resistant
according to
DIN EN 1627,
RC 2 – RC 4¹⁾



ATEX
Directive
2014/34/EU¹⁾

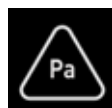

Pressure resistance
as per EN 12210¹⁾



FIRE PROTECTION OUTSIDE DOOR

EI₂90-C5-S_a "TECKENTRUP 62" (THICK REBATE)

- 1- AND 2-LEAFS
- THICK REBATE
- LICENSED FOR OUTDOOR APPLICATION
- CE MARKING ACCORDING TO EN 16034 / 14351-1
- DIFFERENTIAL CLIMATE BEHAVIOUR 2(d)/2(e)

Size range

Modular dimension, 1-leaf:

Width: 625 – 1250 mm
Height: 1750 – 2500 mm*

Modular dimension, 2-leaves:

Width: 1375 – 2500 mm
Height: 1750 – 2500 mm*

Door sizes larger than the above require technical clarification.

Installation in

Modular dimension, 1-leaf:

- Masonry, min. 175 mm
- Concrete, min. 140 mm
- Autoclaved aerated concrete, min 175 mm

Modular dimension, 2-leaves:

- Masonry, min. 175 mm
- Concrete, min. 140 mm
- Autoclaved aerated concrete, min 175 mm

Door leaf

- Double-skinned, 3-sided rebated
- Door leaf thickness: 62 mm
- Sheet thickness: 1.0 mm or 1.5 mm also available in stainless steel 1.0 mm
- Security bolt: per leaf min. 1
- Flush door leaf without hinge stamping
- Door closer (Building inside)
- Bottom seal

Surface

- Door leaf and frame galvanised and powder coated, grey-white similar to RAL 9002
- Also in stainless steel

Frame

- Corner frame, 1.5 mm thick with 3-leaf circumferential seal and lower floor bracket
- Frame attached with exposed masonry installation

Special frame equipment

Counter frame, surrounding frame or block frame

Special equipment

- Upper rain guard
- Bottom weather board
- Glazing (EI90)
- Electric strike
- Closing control (bolt contact) installed
- Opening detector (Reed contact) installed
- RAL of your choice
- Electromechanical blocking device
- and much more



Fire-proof
as per EN 1634-1



Smoke-proof
as per EN 1634-3¹⁾

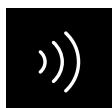

Sound-insulated
as per EN ISO 10140/
EN ISO 717-1 up to
RW 42 dB¹⁾



Burglary-resistant
according to
DIN EN 1627,
RC 2, RC 3¹⁾



ATEX
Directive
2014/34/EU¹⁾

TECKENTRUP

SMOKE PROTECTION DOORS

Smoke creation is a hazard to life. Inhaling even small quantities can result in unconsciousness. Good that our smoke protection doors are ever more frequently being used in both private and public development projects.

Our smoke protection doors are tested in accordance with EN 1634-3, have been issued building authority test certificates in accordance with DIN 18095-1 (RS-1/2-62), and satisfy the requirements of future European standard specifications: S_{200} according to EN 13501-2. If a fire breaks out in a room, the smoke protection doors tested in accordance with DIN 18095 are automatically closed by door closers. A special seal on three sides and the floor seal adapted to the particular application reliably protect against the penetration of smoke.

Uses:

- Detached houses
- Residential facilities
- schools
- Clinics
- Cinemas
- Industrial facilities
- Offices
- Large garages





Smoke-proof according to
EN 1634-3/DIN 18095





SMOKE PROTECTION STEEL DOOR

RS-1/2 "TECKENTRUP 62"

- 1- AND 2-LEAFS
- WITH THIN REBATE
- OPTIONALLY WITH GLAZING

Size range

Modular dimension, 1-leaf:

Width: 625 – 1350 mm

Height: 1750 – 2500 mm

Modular dimension, 2-leaves:

Width: 1375 – 2500 mm

Height: 1750 – 2500 mm

Installation in

- Masonry, min. 115 mm
- Concrete, min. 100 mm
- Lightweight construction stud wall²⁾, min. 100 mm
- Autoclaved aerated concrete, min. 150 mm

Door leaf

- Double-skinned
- 3-leaf rebated (thin rebate)
- Door leaf thickness: 62 mm
- Panel thickness: 1.0 mm
- Security bolt: at least 1

Surface

Door leaf and frame galvanised, powder-coated and primed; grey white like RAL 9002

Frame

- Corner frame, 1.5 mm thick with 3-leaf seal and lower threshold for sliding threshold in door leaf
- Frame attached with exposed masonry installation

Special frame equipment

Counter frame, U frame or block frame

Glazing

- Standard: rectangular - with aluminium glass retainer strips and VSG glazing
- Max. glazing dimensions 904 x 2150 mm
- Round glazing with steel glass retainer strips, VSG glazing
- Round glazing Ø 300, 400, 500 mm

Special equipment

- Prepared for escutcheon hardware
- Top door closer as per EN 1154
- Locks (panic locks)
- Panic bar handle
- Retractable bottom seal



Smoke-proof
as per EN 1634-3/
DIN 18095¹⁾



Sound-insulated
as per EN 10140/
EN 717-1 up to
RW 40 dB¹⁾

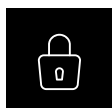

Burglary-resistant
according to
DIN EN 1627
RC 2 – RC 3



ATEX
Directive
2014/34/EU¹⁾

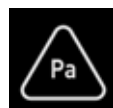

Pressure resistance
as per EN 12210¹⁾



GREAT DESIGN APPEARANCE

A wide variety of colours and surfaces, hinges, door handles, and glazing variants provide ample leeway for the visual design. Choose from a large selection of door handles that match the overall concept. Together with our 3D hinges, the flushness of the cable channels, the concealed frame, and the stainless steel material, the result is an aesthetically pleasing overall impression that appears to have come from a mould.

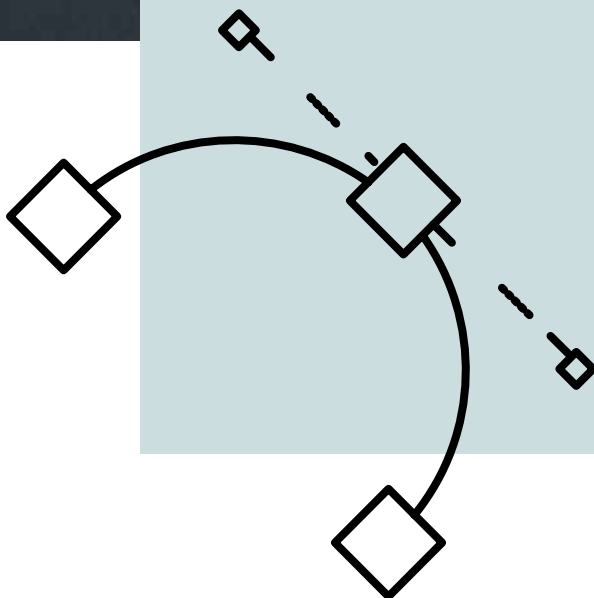



ALWAYS MATCHES YOUR TASTE

Teckentrup fire and smoke protection doors are delivered with a primer coating in grey-white, similar to RAL 9002. Optional are powder end coatings in accordance with RAL colour map.





GLAZING OPTIONS FOR BRIGHT MOMENTS

Depending on approvals, the application, and function, doors can be provided with glazing in various shapes, glass qualities, and frame materials. Additional shapes and arrangements available per the valid price list or upon request.



Glazing with steel frame, optionally in stainless steel



Glazing with aluminium frame



Glazing with aluminium frame with stainless steel appearance



Round glazing in stainless steel

rectangle 1



rectangle 2

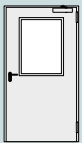
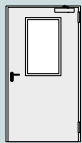
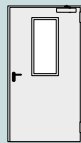
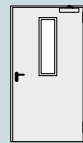

rectangle 3

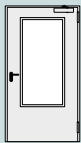
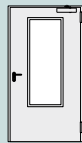
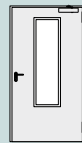
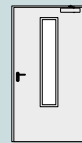

rectangle 4



Clear view

aluminium-glass-holding strips = 120x800

steel glass-holding strips = 140x820

(RC 3 / RC 4)

190x800

315x800

440x800

565x800

210x820

335x820

460x820

585x820

190x1260

315x1260

440x1260

565x1260

545x345

-

round

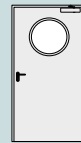
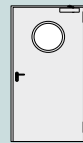

Clear view

steel glass-holding strips =

Ø 300

Ø 400

Ø 500

rectangle of choice

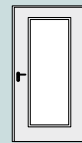

up to 2m²

special glazings

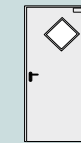

STAINLESS STEEL



SPECIAL ACCENT WITH STAINLESS STEEL

Stainless steel doors are especially dazzling. The representative patterns, matching lever handle sets and hinges create a modern, aesthetic room design. Stainless steel doors are also used in areas with special hygienic requirements.



Stainless steel,
polished
(240er core)

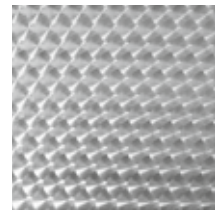

Stainless steel,
circle-polished
(marbled)

DOOR HANDLE

Attractive lever/lever and lever/knob handle sets made of plastic, aluminium, and stainless steel meet all requirements of function and ergonomics. Here you can find a selection of the available handle sets.

Lever/lever and lever/knob handle sets in short and long plate versions



Round handle set, short plate,
aluminium



Round lever/knob handle set, short plate,
aluminium



Round handle set, short plate,
aluminium



Round handle set, long plate,
aluminium

Lever and lever/knob handle set with escutcheon



Round handle set, escutcheon,
aluminium



Round lever/knob handle set, escutcheon,
aluminium



Round handle set, escutcheon,
stainless steel



Round lever/knob handle set, escutcheon,
stainless steel

ES 1 security handle sets for RC2 doors or ES 3 for RC3 and RC4 doors in accordance with EN 1627



Security lever handle set Class ES 1 per DIN 18257,
aluminium



Security lever/knob handle set Class ES 1 per,
aluminium



Security lever/knob handle set Class ES 3 per,
aluminium

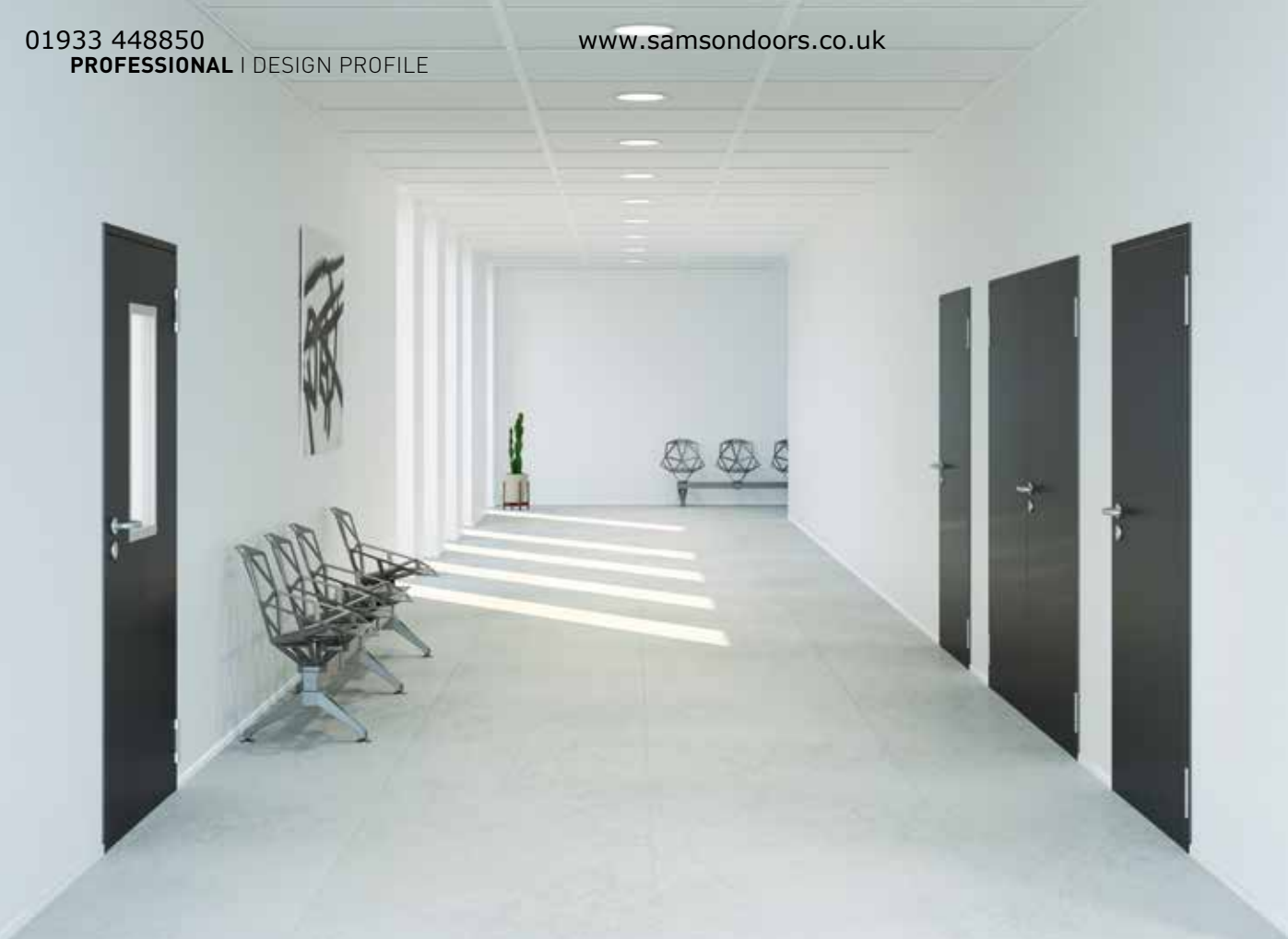

Flush styling with the Teckentrup design profile FB.

Flush doors with harmonious lines, aesthetic recess and harmonious closing edges are features of contemporary architecture. The trend towards a reduction of visible structures through to puristic solutions as well as a formal integration of technical and functional elements has asserted itself in many areas in recent years.

Wish and reality collide on the building site. Cumbersome detailed solutions can quickly consume a lot of time and money and result in an execution risk. When developing our solution, we always also consider a simple installation in addition to the architectural quality and ease of use.

With the Teckentrup design profile FB, we have developed a simple solution for flush styling. We now thereby enable simple installation of doors with contemporary and aesthetic styling.



Strong design

- Flush front
- Attractive and contemporary
- Frame profile in mitre
- Design stainless steel fittings



Strong security

- Anti-burglary protection up to RC 4 possible
- High quality
- Stable construction for high demands



Strong service

- Short delivery times
- Quick installation on the building site



For every purpose

- Construction
- Contemporary industrial architecture
- Offices
- Healthcare or education
- Hotels
- Public buildings
- Server rooms
- Nurseries

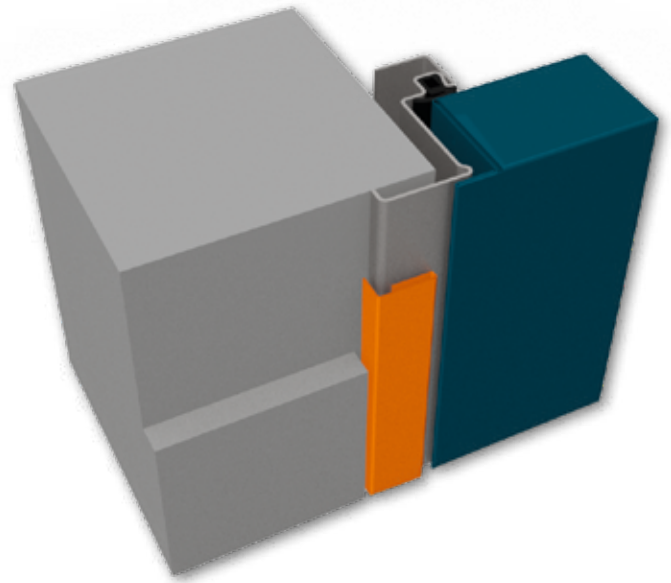

The frame set can be easily combined with standard frames. In combination with a block frame, the door is flush with the wall, as a supplement to corner or closed frames, the door leaf is flush in the frame and on one level with the skirting board. The wide variability of the available door variants is also ensured with the design profile FB: They are available with many additional functions: smoke protection, sound insulation, anti-burglary protection, glazing - the doors can be adapted to almost any structural and planning specification.



Frame mitre



Aesthetic appearance



3D hinges

* Available for:

Thin rebate doors¹⁾

T30/T90, multipurpose, RC2-RC4, sound insulation up to 42dB, smoke protection

Thick rebate doors¹⁾²⁾

T30, multipurpose, RC2-RC3, sound insulation up to 42dB, smoke protection

1) Excluded: Stainless steel doors, upper casing 2) Opening angle reduced to 160°

GREATEST SAFETY FOR MANY APPLICATIONS

The numerous safety functions of project doors are guaranteed with various door closers, arresting devices, drives, anti-panic equipment, etc. The door leaf and frame provide the basis for a long-lasting door element. However, it is only complete with high-quality fittings and electrical equipment which implement current requirements on reliable function with an integrated system.

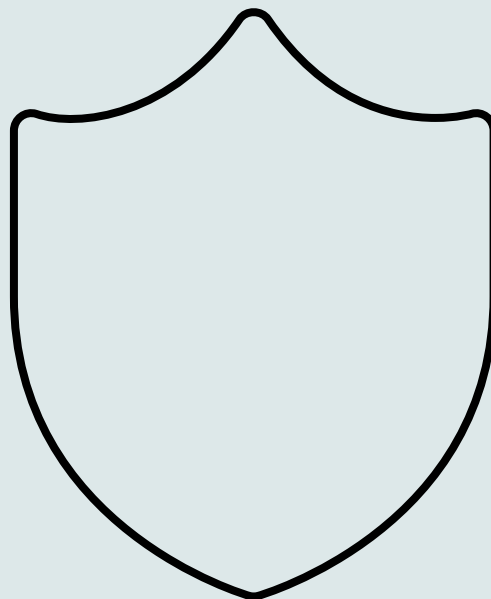



LAYER FOR LAYER QUALITY

Safety, durability, aesthetics – the same requirements also apply for the surfaces of our products.

- a** Internal core depending on application
- b** 2-component industrial adhesive
- c** Anti-corrosion galvanisation
- d** High-strength steel
- e** Anti-corrosion galvanisation
- f** Door leaf and frame primer similar to RAL 9002
- g** Powder-coating finish (optional)





PANIC LOCK

Automatically locking
anti-panic lock with
A panic bar handle
in accordance with DIN 1125,

In the case of an emergency, users must be able to exit the building as quickly as possible. Therefore, it must always be possible to open doors in escape routes. On request, we equip our project doors with locks and fittings for emergency exits in accordance with DIN EN 179 or for escape routes in accordance with DIN EN 1125. Therefore, a safe exit is always guaranteed - even if the doors are locked. Here, panic handle and push bar provide the safest solution because they unlock automatically when physical pressure is applied to the door.

LOCK AND ESCAPE ROUTE TECHNOLOGY

Our locks and locking systems will impress you with the highest level of quality and permanent reliability.



Automatically locking anti-panic locks can also be equipped with multi-point locks.



Push bar: It enables the opening of the door by gently pushing on the release surface.



Standard lock: Mortice lock with knob, perforated profile. Alternatively, other locks such as an additional bolt switching lock or motor lock can also be used.

HINGES AND SECURITY BOLTS

Our doors receive sturdy construction hinges with ball bearings. Flush-closing doors can also be equipped with the completely concealed Tectus hinge system on request.



3D hinge - refinement and functionality: For improved installation friendliness, we offer flexible 3D hinges for our project doors. They are an innovation which enables subsequent adjustment of the door leaf in 3 directions. This enables problem-free compensation of small tolerances. The 3D hinges are available in galvanised and stainless steel versions.



Construction hinge: Construction hinges with ball bearings guarantee that opening and closing the door will always be easy. The hinges are integrated in the door leaf and thus have no influence on the visual appearance of the door leaf surface. The door height can be subsequently adjusted with the supplied hinge hook rings up to 4 mm.



Security bolts: When the door is closed, they protrude into the frame and provide additional protection against forced entry.

ELECTRICAL ATTACHMENTS

Doors with electrical systems are frequently interconnected. This includes escape routes and alarm technology as well as motor and block locks, for example. The overall look of our building doors is not affected by the concealed cable conduit.



Concealed cable access: Doors with electrical systems are frequently interconnected. This includes escape routes and alarm technology as well as motor locks, for example. The overall look of our building doors is not affected by the concealed cable conduit.



Electric strikes / Door drive: The door opener can be used to access the building remotely (2-leaves doors also). Swing door drives provide added comfort and ease of operation, e.g. in hospitals, retirement homes, etc.



Concealed magnetic contact: With its concealed installation in the frame and door leaf, the magnetic contact reports when the door is closed and/or open.



Escape door terminal: Safely locked in everyday use while allowing quick and easy opening in the case of an emergency. These are the most important requirements for doors in escape and emergency routes. Electronic escape route securing systems assist in fulfilling these apparently contradictory requirements.

DOOR CLOSERS

Doors can be closed automatically with door closers, even for fire and smoke protection doors. They are also available with arresting systems or free-wheel function.





INTEGRATED DOOR CLOSERS

A must for aesthetics: a door closer that is completely integrated in the door leaf and thus invisible when the door is closed. Integrated door closers compliment the concealed Tectus hinges.

DESIGN PROFILE FB

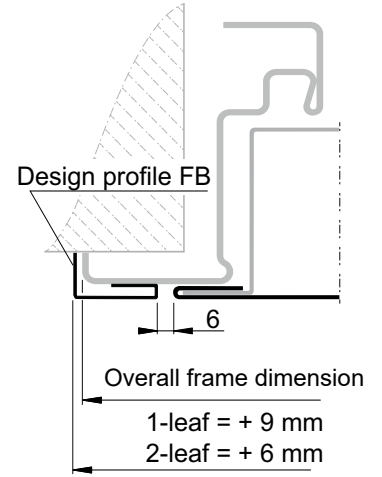
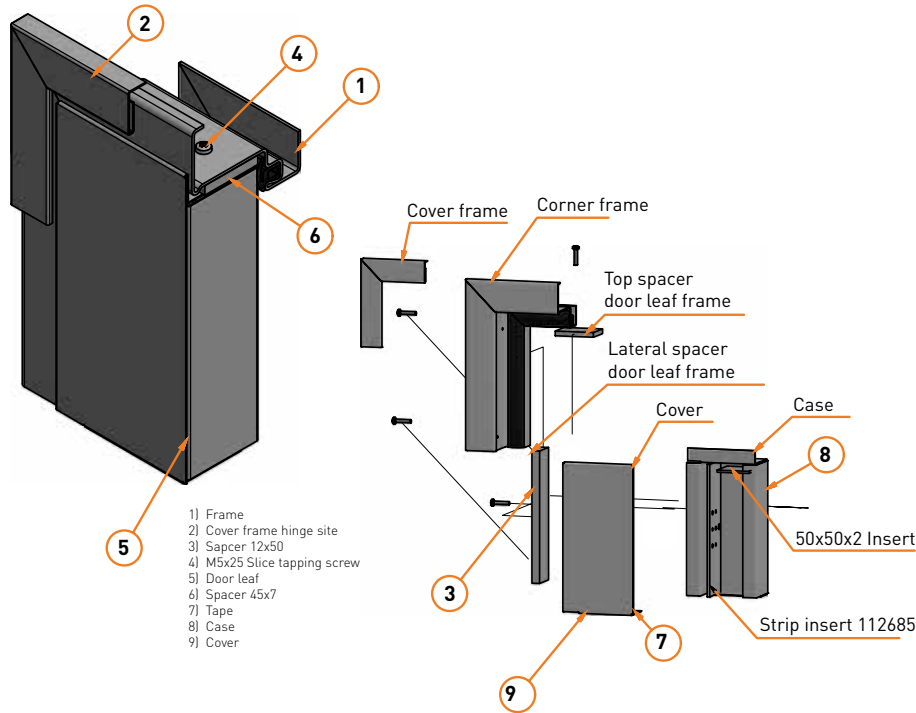

Installation in:

- Masonry
- Concrete
- Autoclaved aerated concrete
- Lightweight construction stud wall only with block frame 4.1 (with T30, multipurpose)

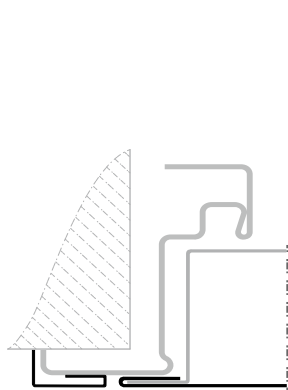

Corner Frame
 (Thin/Thick rebate door)

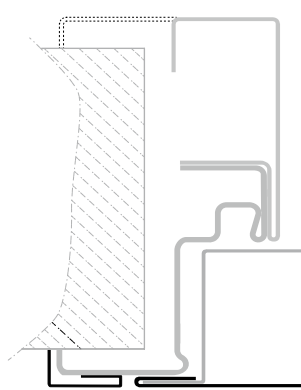

Corner/Counter frame
 (Thin/Thick rebate door)

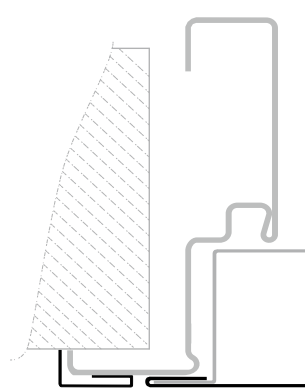

Closed frame
 (Thin/Thick rebate door)

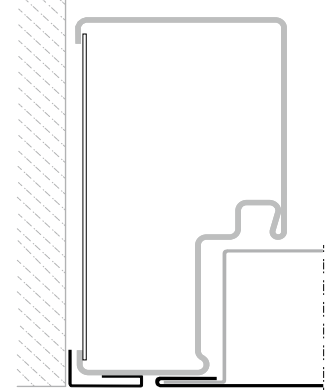

Block frame Typ 4.1
 (Thin/Thick rebate door)

NEW FRAME FASTENING FOR LIGHTWEIGHT CONSTRUCTION STUD WALLS



Without new frame fastening



With new frame fastening

Advantages:

- Aesthetic design thanks to invisible screw connections in the front and rear frame part
- Invisible fastening for construction hinges, almost no longer visible with 3D hinges
- Installation up to 20% faster

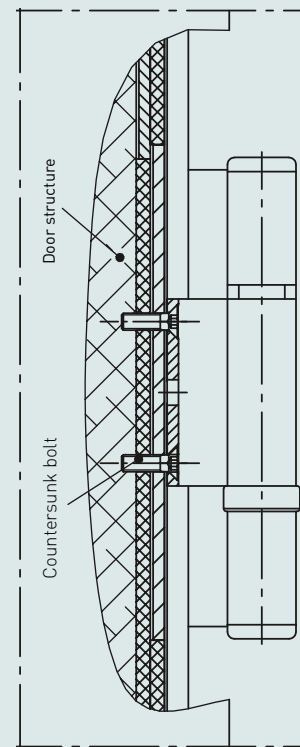
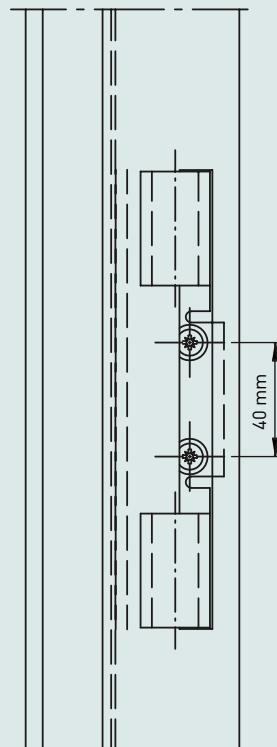
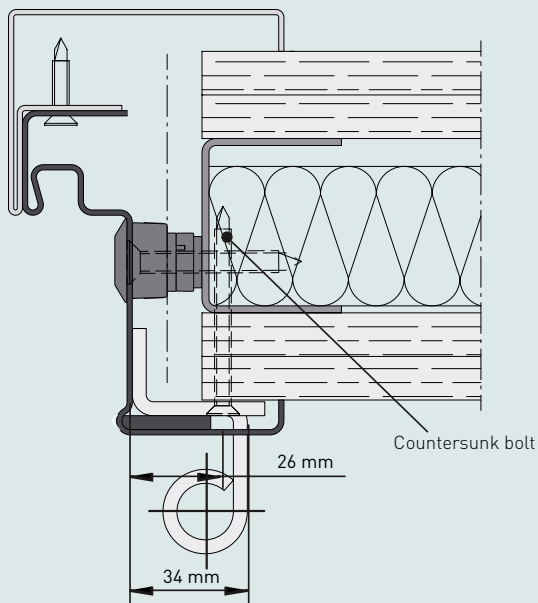

CORNER FRAME

Corner frame for 62er doors,
 wall plug assembly

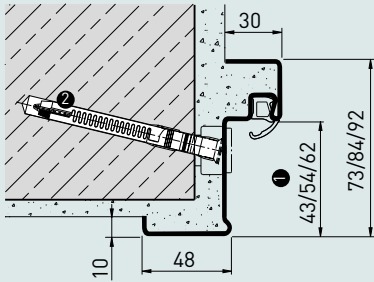

1. Depends on door leaf thickness and rebate construction
2. Installation with frame anchor possible (excluded T60, T90)

Quick and concealed installation with adjustable screws and only one fastening point.



Corner frame for 42 mm doors, wall plug assembly
 (masonry/concrete)

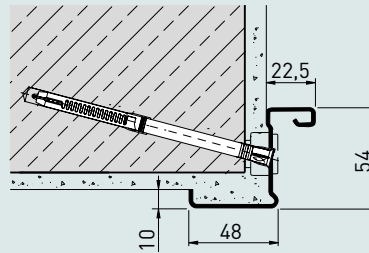

Wall anchor, dowelled,
 (masonry/concrete)

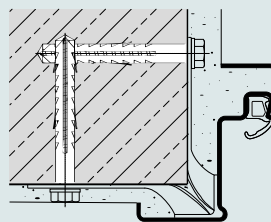

Weld installation with
 sliding anchor (exposed
 masonry)

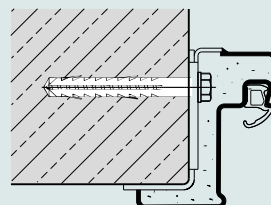

Wall anchor, mortared,
 (masonry/concrete)

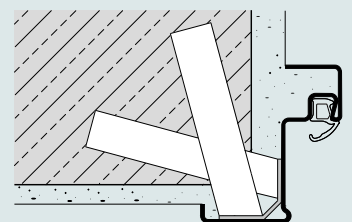

Wall plug installation
 (aerated concrete)

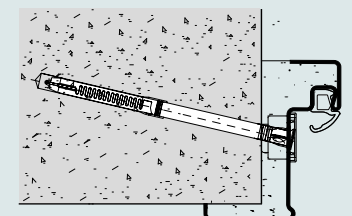

TSM CORNER FRAME - DRY, QUICK ASSEMBLY

- MORTAR-FREE FRAME FASTENING
- READY-TO-ASSEMBLE SYSTEM
- OPTIONALLY ALSO IN REVEAL DEPTH



Mortar-free wall plug assembly
(masonry/concrete)

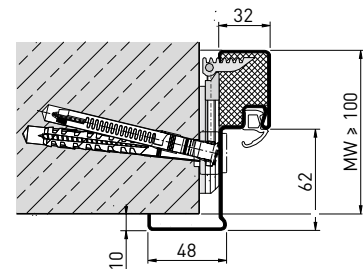

- Frame factory infill with mineral wool
- No time-consuming grouting - no mess
- Complete installation in one step
- Simple fixing of the frame with a special frame anchor
- Improvement of the overall appearance with concealed fastening
- Ready-to-install frame also suitable for retroactive installation in a finished wall

CORNER/COUNTER FRAME

Corner/counter frame for 62 mm doors
 Wall plug installation with slide anchor
 (masonry/concrete)

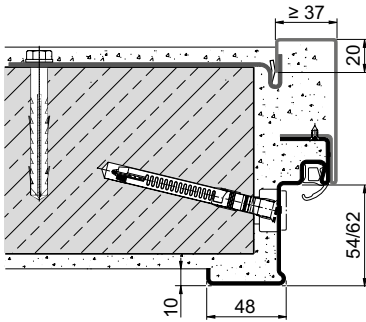

Depends on door leaf thickness and rebate construction

Corner/counter frame for 42 mm doors
 Wall plug installation with slide anchor
 (masonry/concrete)

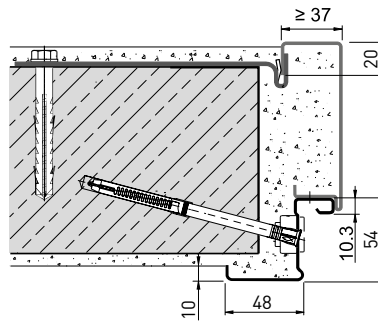

Wall anchor, dowelled with slide anchors
 (masonry/concrete)

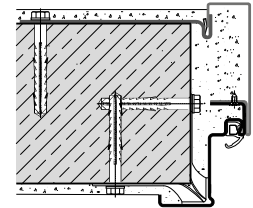

Wall plug and hinged anchor installation (masonry/concrete)

Wall plug and hinged anchor installation (exposed masonry/autoclaved aerated concrete walls)

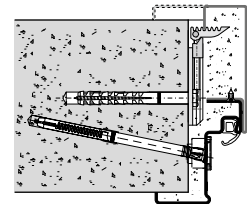
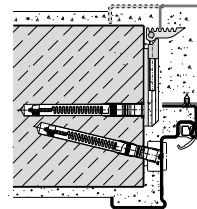

Concealed installation of the counter frame with special fold anchor



Weld installation with anchor bracket (autoclaved aerated concrete walls)

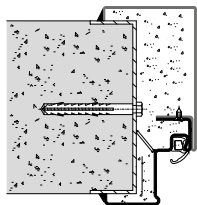

Countersunk screw fastening (lightweight partition)

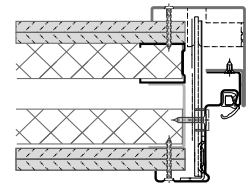

CIRCUMFERENTIAL FRAME

Wall plug with slide anchor (masonry / concrete)

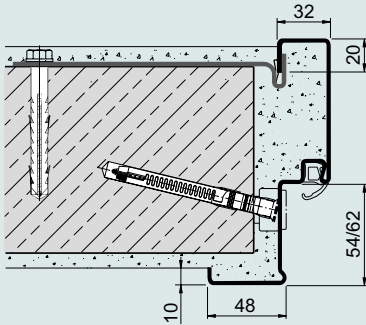

Wall anchor, dowelled with slide anchors (masonry/ concrete)

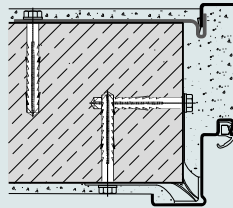

Wall plug and hinged anchor installation (masonry/concrete)

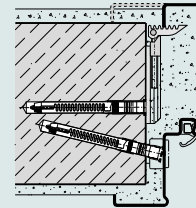

Depending on door leaf thickness and rebate design

Quick and concealed installation of the closed frame using adjusting screws and slide anchors.

Wall plug and hinged anchor installation (exposed masonry/autoclaved aerated concrete walls)

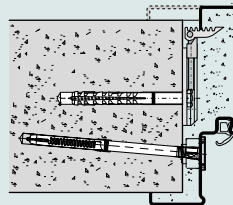

Weld installation with anchor bracket (autoclaved aerated concrete walls)

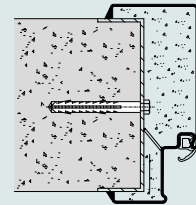

Countersunk screw attachment (lightweight construction stud wall)

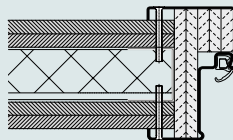

BLOCK FRAME

Type 4.1 Wall plug assembly with plaster filling (masonry/autoclaved aerated concrete)

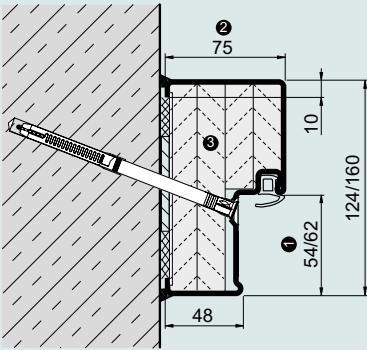

1. Depends on door leaf thickness and rebate construction
2. For block frame Type 4.2 = 100 mm
3. Factory infill optional

Quick and easy installation of a block frame Type 4.1 with factory infill



Type 2.2 Concealed wall plug assembly in front of opening (masonry/concrete),

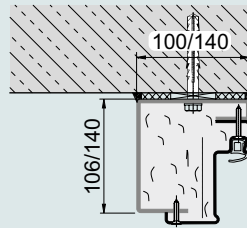

On-site screw-mounting and optional factory infill

Type 2.3 Concealed wall plug assembly in opening (masonry/autoclaved aerated concrete)

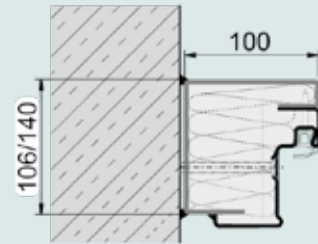

Factory pre-installed and optional factory infill

Type 5.1 Wall plug assembly in front of opening (masonry/concrete),

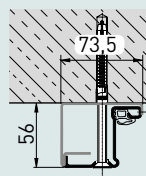

Type 5.3 / 5.3 L Wall plug assembly in the opening (masonry/concrete/steel beams)

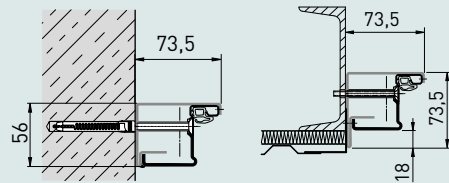

Version for single- and double-leaf Multi-purpose doors Teckentrup dw 42-1/2, optional factory infill

BOTTOM SEAL

Sliding threshold

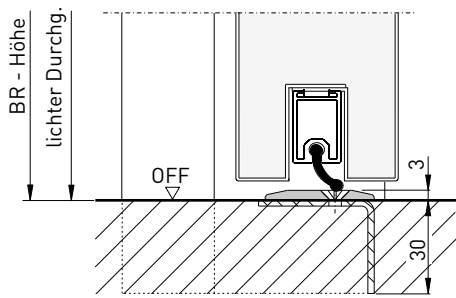

Buffer seal

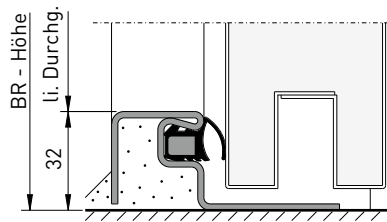

Retractable bottom seal

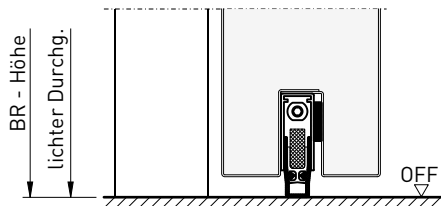

Double retractable bottom sea
(for highly sound-insulated doors)

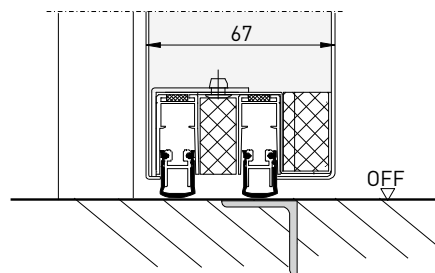

Double sliding threshold and bottom profile
(for high sound-insulated doors)

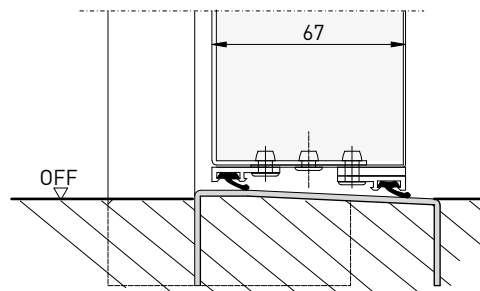

Time delayed retractable bottom sea

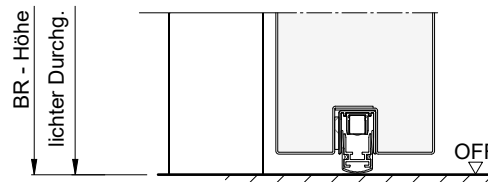

Main qualification		Fire-resistant T30												
DOOR NAME		HT8-D (thin rebate)	FSA 42 (thin rebate)		FSA 62 (thin rebate)		FSA 62 DF (thick rebate)		FSA 72 ST (flush)		FSA GL (all-glas)		EI ₃₀ -C5-S ₃ (thin rebate)	
Number of leaves		1-leaf	1-leaf	2-leafs	1-leaf	2-leafs	1-leaf	2-leafs	1-leaf	2-leafs	1-leaf	2-leafs	1-leaf	2-leafs
Product on pages		16/17	18/19	18/19	22/23	22/23	24/25	24/25	26/27	26/27	28/29	28/29	32/33	32/33
ADDITIONAL QUALIFICATIONS, STANDARD														
Heat insulation		1,5	1,5	1,7	1,3	1,4	1,3	1,4	-	-	-	-	1,3	1,4
Differential climate behaviour		-	-	-	-	-	-	-	-	-	-	-	2(d)/2(e)	2(d)/2(e)
ADDITIONAL QUALIFICATIONS WITH APPROPRIATE EQUIPMENT														
Smoke protection		■	■	■	■	■	■	■	■	■	■	■	■	■
Sound insulation (dB)		37-39	37	37	35-42	37-42	38-42	38-42	42	42	34	-	35-42	37-42
Anti-burglary characteristics		WK 2	WK 2	-	RC 2-4	RC 2-4	RC 2-3	RC 2-3	RC 2	RC 2	-	-	RC 2-4	RC 2-4
ATEX		-	-	-	■	■	■	■	-	-	-	■	-	-
CE marking (outdoor use)		-	-	-	-	-	-	-	-	-	-	-	■	■
Pressure resistance (on request)		-	-	-	■	■	-	-	-	-	-	-	■	■
DOOR LEAF														
Leaf thickness (mm)		42	42	42	62	62	62	62	72	72	27	27	62	62
Panel thickness (mm)	primed	0,9	1,0	1,0	1,0/1,5	1,0/1,5	1,0/1,5	1,0/1,5	1,0	1,0	-	-	1,0/1,5	1,0/1,5
	Stainless steel	-	-	-	1,0	1,0	1,0	1,0	-	-	-	-	1,0	1,0
Rebate	Thin rebate	■	■	■	■	■	-	-	-	-	-	-	■	■
	Thick rebate	-	-	-	-	-	■	■	-	-	-	-	-	-
	flush	-	-	-	-	-	-	-	■	■	-	-	-	-
Glazing possible		-	-	-	■	■	■	■	■	■	■	■	■	■
Upper casing/top light possible		-	-	-	■	■	■	■	-	-	-	-	■	■
FRAME VARIANTS														
Corner frame		■	■	■	■	■	■	■	■	■	■	■	■	■
Counter frame		■	■	■	■	■	■	■	■	■	■	■	■	■
Circumferential frame		-	■	■	■	■	■	■	■	■	■	■	■	■
Block frame		-	■	■	■	■	■	■	■	■	■	■	■	■
INSTALLATION IN														
Masonry		■	■	■	■	■	■	■	■	■	■	■	■	■
Concrete		■	■	■	■	■	■	■	■	■	■	■	■	■
Aerated concrete		-	■	■	■	■	■	■	■	■	■	■	■	■
Lightweight partition		-	■	■	■	■	■	■	■	■	■	-	-	-
Clad wooden supports		-	■	■	■	■	■	■	■	■	-	-	-	-
Greater heights		-	-	-	-	-	-	-	-	-	-	-	-	-
BASIC DIMENSIONS (MM)														
Width	minimum	750	625	1375	500	1375	625	1375	625	1375	625	1375	500	1375
	maximum	1125	1125	2250	1500	3000	1500	3000	1350	2500	1250	2500	1250	2500
Height	minimum	875	1750	1750	500	1750	1375	1750	1750	1750	1750	1750	500	1750
	maximum	2125	2250	2250	4000	4000	3500	3500	2500	2500	2500	2500	2500	2500
Max. total height with upper casing		-	-	-	4600	4600	3750	3750	-	-	-	-	3500	3500

■ = Standard

		highly fire-resistant T60				fire-proof T90								smoke-proof	
EI ₃₀ -C5-S _a (thick rebate)		FSA 62 (thin rebate)		EI ₆₀ -C5-S _a (thin rebate)		FSA 62 (thin rebate)		FSA 62 DF (thick rebate)		EI ₉₀ -C5-S _a (thin rebate)		EI ₉₀ -C5-S _a (thick rebate)		RS-1/2 (thin rebate)	
1-leaf	2-leafs	1-leaf	2-leafs	1-leaf	2-leafs	1-leaf	2-leafs	1-leaf	2-leafs	1-leaf	2-leafs	1-leaf	2-leafs	1-leaf	2-leafs
34/35	34/35	36/37	36/37	38/39	38/39	40/41	40/41	42/43	42/43	44/45	44/45	46/47	46/47	50/51	50/51
1,3	1,4	1,3	1,4	1,3	1,4	1,6	1,7	1,4	1,5	1,6	1,7	1,4	1,5	1,3	1,4
2(d)/2(e)	2(d)/2(e)	-	-	2(d)/2(e)	2(d)/2(e)	-	-	-	-	2(d)/2(e)	2(d)/2(e)	2(d)/2(e)	2(d)/2(e)	-	-
■	■	■	■	■	■	■	■	■	■	■	■	■	■	■	■
38-42	38-42	33	33	33	33	42	42	41	36-41	42	42	42	42	35-37	37-38
RC 2-3	RC 2-3	RC 2-3	RC 2-3	RC 2-3	RC 2-3	RC 2-4	RC 2-4	WK 2-3	-	RC 2-4	RC 2-4	RC 2-3	RC 2-3	RC 2-3	RC 2-3
■	■	■	■	■	■	■	■	■	■	■	■	■	■	■	■
■	■	-	-	■	■	-	-	-	-	■	■	■	■	-	-
-	-	■	■	■	■	■	■	-	-	■	■	-	-	■	■
62	62	62	62	62	62	62	62	62/64	62/64	62	62	62	62	62	62
1,0/1,5	1,0/1,5	1,0	1,0	1,0	1,0	1/1,5	1/1,5	1,0/1,5	1,0/1,5	1,0/1,5	1,0/1,5	1,0/1,5	1,0/1,5	1,0	1,0
1,0	1,0	1,0	1,0	-	-	1,0	1,0	1,0	1,0	1,0	1,0	1,0	1,0	-	-
-	-	■	■	■	■	■	■	-	-	■	■	-	-	■	■
■	■	-	-	-	-	-	-	■	■	-	-	■	■	-	-
-	-	-	-	-	-	-	-	-	-	-	-	-	-	-	-
■	■	■	-	■	■	■	■	■	■	■	■	■	■	■	■
■	■	-	-	-	-	■	■	-	-	■	■	-	-	-	-
■	■	■	■	■	■	■	■	■	■	■	■	■	■	■	■
■	■	■	■	■	■	■	■	■	■	■	■	■	■	■	■
■	■	■	■	■	■	■	■	■	■	■	■	■	■	■	■
■	■	■	■	■	■	■	■	■	■	■	■	■	■	■	■
■	■	■	■	■	■	■	■	■	■	■	■	■	■	■	■
■	■	■	■	■	■	■	■	■	■	■	■	■	■	■	■
-	-	■	■	-	-	■	■	■	■	-	-	-	-	■	■
-	-	-	-	-	-	-	-	-	-	-	-	-	-	■	■
-	-	-	-	-	-	■	■	-	-	■	■	-	-	-	-
500	1375	625	1375	625	1375	500	1375	625	1375	500	1375	625	1375	625	1375
1250	2500	1250	2500	1350	2500	1500	3000	1500	3250	1250	2500	1250	2500	1350	2500
500	1750	650	1750	650	1750	500	1750	1750	1750	500	1750	1750	1750	1750	1750
2500	2500	2500	2500	2500	2500	3000	3000	3500	3500	2500	2500	2500	2500	2500	2500
3500	3500	-	-	-	-	4000	4000	-	-	3500	3500	-	-	-	-

TECKENTRUP | PROFESSIONAL

DESIGN | SECURITY | SERVICE

Professional solutions



We are happy to help.

Samson

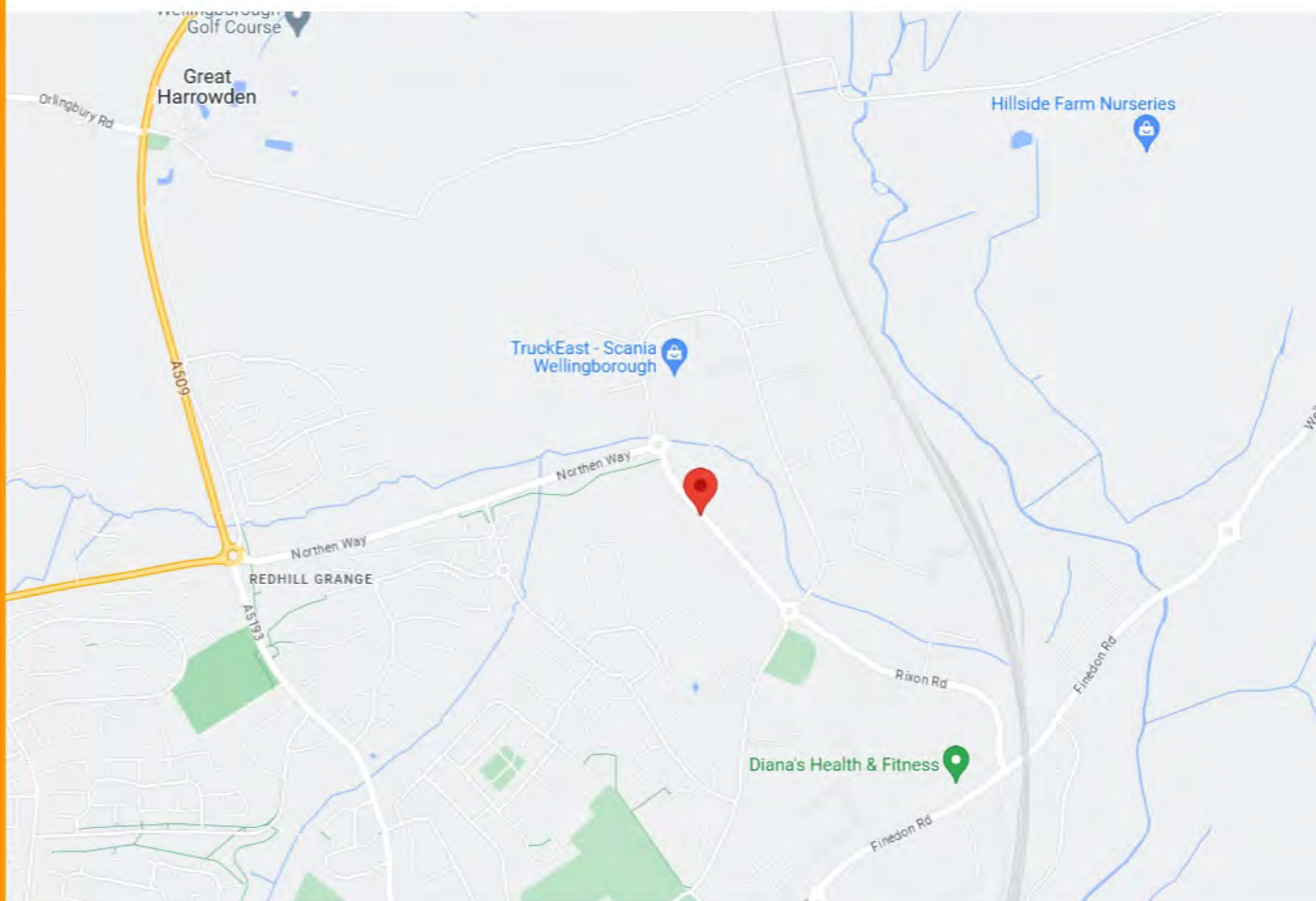

**29-31 STEWARTS ROAD
WELLINGBOROUGH
NORTHAMPTONSHIRE
NN8 4RJ**

**EMAIL: ENQUIRIES@SAMSONDOORS.CO.UK
TELEPHONE: (01933) 448850
MON - FRI 8:00AM - 5:00PM**

SAMSON

