



ThermoComp Entrance Doors

High performance external doors





CONTENT

6	Good Reasons to try Hörmann
10	Traditional Range
22	Cottage Range
28	Contemporary Range
34	Colours and Decor Surfaces
35	Frame details, Sidepanels and Toplights
36	Glass Range
37	Decorative Glazing options
40	Accessories
42	Safety Equipment
44	Fire Door Range

The colours and surface finishes shown are subject to the limitations of the printing process and cannot be regarded as binding.

All rights reserved. No part may be reproduced without our prior permission. Subject to changes.

◀ **Style TR01** in Jet Black with lever/lever handle, knocker and letterplate in Chrome

There's no place like home

After a hard day at work there is nothing better than coming home to a relaxing environment and enjoying your home comforts. To be able to enjoy time with your loved ones, you have to feel safe and at ease in your own four walls, it all begins with your entrance door.

For a style to suit your taste and the security to put you at ease, Hörmann ThermoComp entrance doors will provide you with that and more.





GOOD REASONS TO TRY HÖRMANN

“A good reputation must be earned.”

August Hörmann

In keeping with the tradition started by the company's founder, the name Hörmann delivers brand name quality with extensive product expertise. The family business has over 80 years of experience as a construction component specialist and sees itself as your partner from the very beginning of building and renovation projects. It's no surprise that Hörmann is one of Europe's most successful door providers. This makes a Hörmann door a reassuring purchase.



1 Quality products from Great Britain

All doors are developed and manufactured by Hörmann. Our highly qualified employees work intensively on new products, continual further developments and improvements to details. Patents and unique products on the market are the result of this. Endurance tests under real conditions ensure mature series products with Hörmann quality.



2 Doors for generations

We are convinced of our products and our uncompromising quality assurance. That is why you will enjoy a Hörmann door in your house for many years.

3 An eye on the future

Hörmann is setting a good example. This is why the company has obtained over 70 % of its required energy from green sources and will continue to increase this percentage. At the same time, many tonnes of CO² are saved each year thanks to the introduction of an intelligent and certified energy management system. And last but not least, Hörmann offers products for sustainable construction. Find out more about Hörmann's environmental activities in the "We Think Green" brochure.



GOOD REASONS TO TRY HÖRMANN



4 Security as standard

Our doors are fitted with high security multi-point locking systems as standard. These locks meet the requirements of PAS 23/24 and are tested in accordance with BS EN ISO 9001 Quality Assurance. We also supply a 'split spindle' option which further enhances security.

The door locks on the latch as soon as the door is shut and requires a key to unlock it.

To take the security of our doors to an even higher level, we also fit our specially designed triple dogbolt system as standard. This involves two sets of triple hinge bolts that secure the door to the frame, protecting you against intruders.

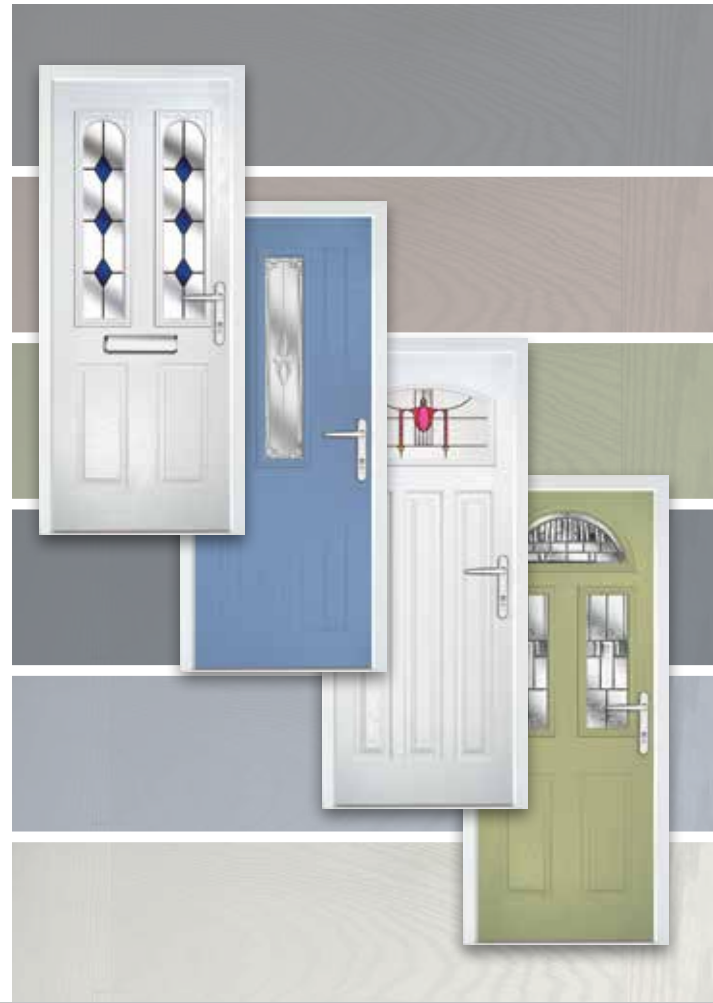

5 Glazings

Making these doors even more special is the fact that each decorative glass panel has been hand crafted with bevels to complement the door.

6 Individual designs

Design your door exactly the way you want it, to your own individual taste. You can choose between various colours and decors as well as glazings. Discover the design possibilities from page 34.



THERMOCOMP

Traditional range

Whether you live on a Victorian terrace or a modern development, your home is as individual as you are and deserves a facade that makes a unique statement. By choosing a modern, composite door you can benefit from a wide variety of styles, sizes, colours, glazing and fixtures.

Exploring the available options gives you fresh ideas and ensures that you arrive at a front door that is highly personalised and a complete reflection of your tastes.



The four panel makes a smart addition to any home



Style TR37

Door leaf in Woodstain finish Golden Oak, with 4 panels, frame in Traffic White, Gold lever/lever handle, Gold letterplate



Style TR04

Door leaf in Standard colour Traffic White, with 4 panels, frame in Traffic White, Chrome lever/lever handle, Elegance glazing



Style TR32

Door leaf in Standard colour Traffic White, with 4 panels, frame in Traffic White, Chrome lever/lever handle, Chrome letterplate, Diamonds glazing in Blue



Style TR33

Door leaf in Heritage colour Slate Grey, with 4 panels, frame in Traffic White, Black lever/lever handle, Black letterplate, Black knocker with eyeviewer, Traditional Etch glazing in Grey

Side element

Sidelight panels Style TRS17, Traditional Etch glazing in Grey

Design options

Available glazings

- Clear and patterned obscure glass: styles TR04 / TR32 / TR33
- Georgian Grid: style TR04
- Decorative glazing options:

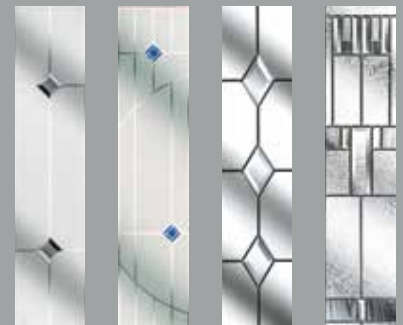

Traditional Etch: TR04 TR32 TR33	Retro: TR04 TR32 TR33	Diamonds: TR04 TR32 TR33	Prairie: TR04
---	--------------------------------	-----------------------------------	------------------



Gibson: TR04	Flair: TR04 TR32 TR33	Diamond Cut: TR04	Linear: TR04
-----------------	--------------------------------	----------------------	-----------------



Elegance: TR04	Reflections: TR04	Harmony: TR04
-------------------	----------------------	------------------

More options:

- | | |
|--------------------|---------|
| Colours | Page 34 |
| Sidepanels | Page 35 |
| Glazings | Page 36 |
| Accessories | Page 40 |

A truly versatile door has six panels



Style TR01

Door leaf in Heritage colour Chartwell Green, with 6 panels, frame in Traffic White, Chrome lever/lever handle

Style TR80

For narrow openings, in Standard colour Traffic White on both sides only



Style TR02

Door leaf in Heritage colour Cream, with 6 panels, frame in Traffic White, Gold lever/lever handle, Gold letterplate, Gibson glazing

Side element

Sidelight panel Style TRS2, Gibson glazing



Style TR27

Door leaf in Heritage colour Silver Grey, with 6 panels, frame in Traffic White, Chrome lever/lever handle, Chrome knocker, Harmony glazing in Silver Grey

Side element

Sidelight panels Style TRS4, Harmony glazing in Silver Grey

Design options

Available glazings

- Clear and patterned obscure glass: styles TR02 / TR27
- Decorative glazing options:



Traditional Etch: TR02



Retro: TR02 TR27



Diamonds: TR02 TR27



Prairie: TR02 TR27



Gibson: TR02 TR27



Diamond Cut: TR02 TR27



Elegance: TR02 TR27



Reflections: TR02 TR27



Harmony: TR02 TR27

More options:

Colours	Page 34
Sidepanels	Page 35
Glazings	Page 36
Accessories	Page 40

A classic half moon top panel for extra light



Style TR1E

Door leaf in Standard colour Traffic White, with 5 panels, frame in Traffic White, Chrome lever/lever handle, Chrome letterplate, Retro glazing in Black



Style TR1F

Door leaf in Heritage colour Willow, with 5 panels, frame in Traffic White, White lever/lever handle, Prairie glazing



Style TR22

Door leaf in Standard colour Traffic White, with 5 panels, frame in Traffic White, Chrome lever/lever handle, Chrome letterplate, Grid Lite Etch



Style TR29

Door leaf in Standard colour Steel Blue, with 3 panels, frame in Traffic White, Chrome lever/lever handle, Chrome letterplate, Reflection glazing

Side element

Sidelight panels Style TRS16, Reflections glazing

Design options

Available glazings

- Clear and patterned obscure glass: styles
TR1E / TR1F / TR22 / TR29
- Decorative glazing options:



Retro:
TR1E
TR1F
TR29



Diamonds:
TR1E
TR1F
TR29



Prairie:
TR1E
TR1F



Gibson:
TR1E
TR1F



Diamond Cut:
TR1E
TR1F
TR29



Elegance:
TR1E
TR1F
TR29



Reflections:
TR1E
TR1F
TR29



Harmony:
TR1E
TR1F



French:
TR29



Grid Lite Etch:
style TR22



Grid Lite Obscure:
style TR22

More options:

- Colours Page 34
- Sidepanels Page 35
- Glazings Page 36
- Accessories Page 40



A distinctive large glass makes a key feature



Style TR06

Door leaf in Standard colour Traffic White, with 3 panels, frame in Traffic White, Chrome lever/lever handle, French glazing

Style TR36

For narrow openings, in Standard colour Traffic White on both sides only



Style TR1G

Door leaf in Standard colour Signal Red, with 3 panels, frame in Traffic White, Chrome lever/lever handle, Diamond Cut glazing

Design options

Available glazings

- Clear and patterned obscure glass: styles TR06 / TR36 / TR1G
- Georgian Grid: style TR06
- Decorative glazing options:

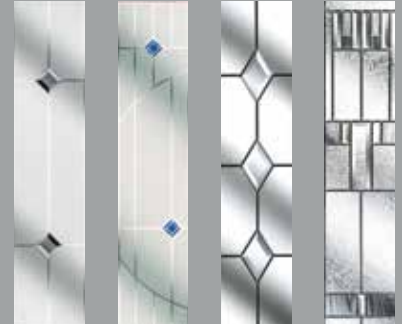

Traditional Etch: TR06

Retro: TR06

Diamonds: TR06

Prairie: TR1G



Diamond Cut: TR06 TR1G

Linear: TR06

Elegance: TR06

Reflections: TR1G



French: TR06

Simplicity: TR1G

More options:

Colours	Page 34
Sidepanels	Page 35
Glazings	Page 36
Accessories	Page 40

◀ **Style TR06** in Steel Blue and Elegance glazing, with lever/lever handles and letterplate in Chrome



Style TR94

Door leaf in Standard colour Steel Blue, with 4 panels, frame in Traffic White, Chrome Thunderbolt Heritage Lock, Numbers glazing in Deep Red and Dark Blue

Mix our vertical panels with these beautiful glass designs



Style TR94

Door leaf in Standard colour Traffic White, with 4 panels, frame in Traffic White, Chrome lever/lever handle, Victoriana glazing in Red



Style TR2J

Door leaf in Heritage colour Cream, with 6 panels, frame in Traffic White, Brushed Stainless lever/lever handle

Design options

Available glazings

- Clear and patterned obscure glass: style TR94
- Decorative glazing options:

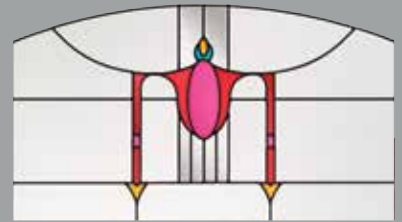

Victoriana: TR94



Dorchester: TR94



Simplicity: TR94



Reflections: TR94



Numbers: TR94

More options:

Colours	Page 34
Sidepanels	Page 35
Glazings	Page 36
Accessories	Page 40



THERMOCOMP

Cottage Range

Character properties are perennially popular among home buyers who are looking for a piece of history. These period houses usually offer several original features which their owners seek to preserve. Even when looking to renovate or improve these homes, attention to detail is key, so modern fixtures with heritage overtones are the ideal solution.





Style TR1H

Door leaf in Woodstain finish Rosewood, with tongue and groove effect panels, frame in Traffic White, Gold lever/lever handle, Gold letterplate, Gold knocker with Eyeviewer

A 'tongue and groove' effect which is reminiscent of a farmhouse door



Style TR1J

Door leaf in Standard colour Traffic White, with tongue and groove effect panels, frame in Traffic White, Chrome lever/lever handle, Elegance glazing



Style TR1W

Door leaf in Heritage colour Larkspur Blue, with tongue and groove effect panels, frame in Traffic White, Chrome lever/lever handle, Gibson glazing

Design options

Available glazings

- Clear and patterned obscure glass: styles TR1J / TR1W
- Georgian Grid: styles TR1J / TR1W
- Decorative glazing options:



Traditional Etch: TR1J TR1W



Retro: TR1J TR1W



Diamonds: TR1J TR1W



Prairie: TR1W



Gibson: TR1W



Flair: TR1W



Diamond Cut: TR1J TR1W



Linear: TR1W



Elegance: TR1J TR1W



Reflections: TR1J TR1W



French: TR1J

More options:

- Colours** Page 34
- Sidepanels** Page 35
- Glazings** Page 36
- Accessories** Page 40

A sense of the countryside to any home with a solid wood-look finish



Style TR1K

Door leaf in Standard colour Traffic White, with tongue and groove effect panels, frame in Traffic White, Brushed Stainless lever/lever handle, Brushed Stainless letterplate, Traditional Etch glazing in Grey



Style TR1B

Door leaf in Heritage colour Chartwell Green, with tongue and groove effect panels, frame in Traffic White, Chrome lever/lever handle, Diamond Cut glazing



Style TR2F

Door leaf in Heritage colour Silver Grey, with tongue and groove effect panels, frame in Traffic White, Chrome lever/lever handle, Reflections glazing



Style TR1M

Door leaf in Standard colour Pine Green, with tongue and groove effect panels, frame in Traffic White, Chrome lever/lever handle, letterplate in Chrome, Elegance glazing



Style TR1L

Door leaf in Standard colour Traffic White, with tongue and groove effect panels, frame in Traffic White, Black lever/lever handle, Simplicity glazing

Design options

Available glazings

- Clear and patterned obscure glass: styles TR1K/TR1B/TR2F/TR1M/TR1L
- Decorative glazing options:

			
Traditional Etch: TR1K TR1B TR2F TR1M TR1L	Retro: TR1K TR1B TR2F	Diamonds: TR1L TR1M	Prairie: TR1K TR1B TR2F
			
Diamond Cut: TR1K TR1B TR2F	Elegance: TR1K TR1B TR2F TR1M	Reflections: TR1K TR1B TR2F	Simplicity: TR1L

More options:

Colours	Page 34
Sidepanels	Page 35
Glazings	Page 36
Accessories	Page 40



THERMOCOMP

Contemporary Range

There has been a significant number of new homes built over the last 50 years. Often, these more modern houses need doors and windows that are in keeping with the surrounding architecture. There are an increasing number of exciting, contemporary doors and other fixtures available to homeowners looking to give their post-war house a clean, fresh look.

These ultra new door styles provide instant sophistication to a home.





Style TR09

Door leaf in Standard colour
Steel Blue, with 1 panel, frame in
Traffic White, Chrome lever/lever
handle, Chrome letterplate

◀ **Style TR17** in Slate grey and Linear glazing, with Inline bar handle

The definition of modernity



Style TR17

Door leaf in Standard colour Traffic White, with 1 panel, frame in Traffic White, Steel Bar Offset 120, Linear glazing



Style TR13

Door leaf in Heritage colour Willow, with 1 panel, frame in Traffic White, Chrome lever/lever handle, Panache glazing

Design options

Available glazings

- Clear and patterned obscure glass: styles TR17 / TR13
- Decorative glazing options:



Linear: TR17



Clear Lines: TR13



Satin Lines: TR13



Panache: TR13

More options:

Colours	Page 34
Sidepanels	Page 35
Glazings	Page 36
Accessories	Page 40

Modern Style-Doors with classic wood-look finish



Style TR1C

Door leaf in Standard colour Traffic White, with 1 panel, frame in Traffic White, Chrome lever/lever handle, Traditional Etch glazing in Grey



Style TR2H

Door leaf in Heritage colour Larkspur Blue, with 1 panel, frame in Traffic White, Steel Bar Inline 60, Simplicity glazing



Style TR1D

Door leaf in Heritage colour Anthracite Grey, with 1 panel, frame in Traffic White, Chrome lever/lever handle, Diamonds glazing in Red



Style TR76

Door leaf in Standard colour Traffic White, with 1 panel, frame in Traffic White, Gold lever/lever handle, Reflections glazing



Style TR61

Door leaf in Heritage colour Wine Red, with 1 panel, frame in Traffic White, Chrome lever/lever handle, Clear glazing

Design options

Available glazings

- Clear and patterned obscure glass: styles TR1C / TR2H / TR1D / TR76 / TR61
- Decorative glazing options:



Traditional Etch: TR1C TR2H



Retro: TR1D TR76



Diamonds: TR1D



Diamond Cut: TR1D



Elegance: TR76



Reflections: TR1D TR76

More options:

Colours	Page 34
Sidepanels	Page 35
Glazings	Page 36
Accessories	Page 40

COLOURS AND DECOR SURFACES

Whatever you want!

Our composite door designs are available in a range of five standard colours and two woodstain finishes, but with our high specification paint plant, we can provide a wide range of specialist colours and a colour matching service. This state-of-the-art mixing system allows a choice of colour options from the popular RAL colour range – it's a veritable rainbow and means there is a colour for everyone.

Bespoke Colours

Our mixing system allows a choice of colour options from the RAL colour range.



Standard colours



Jet Black



Signal Red



Steel Blue



Traffic White



Pine Green

Heritage colours

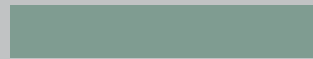

Chartwell Green

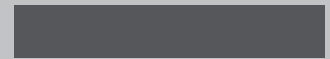

Slate Grey

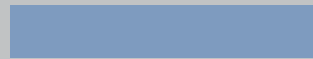

Larkspur Blue



Desert Sand



Willow



Camouflage Beige



Brunswick Green

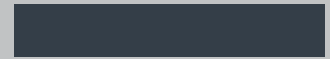

Anthracite Grey



Wine Red

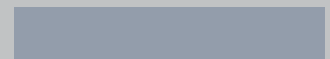

Silver Grey

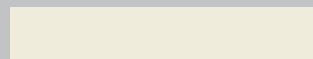

Cream

Woodgrain finishes



Golden Oak

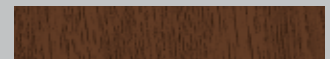

Rosewood

FRAME DETAILS / SIDEPANELS AND TOPLIGHTS

Frame options

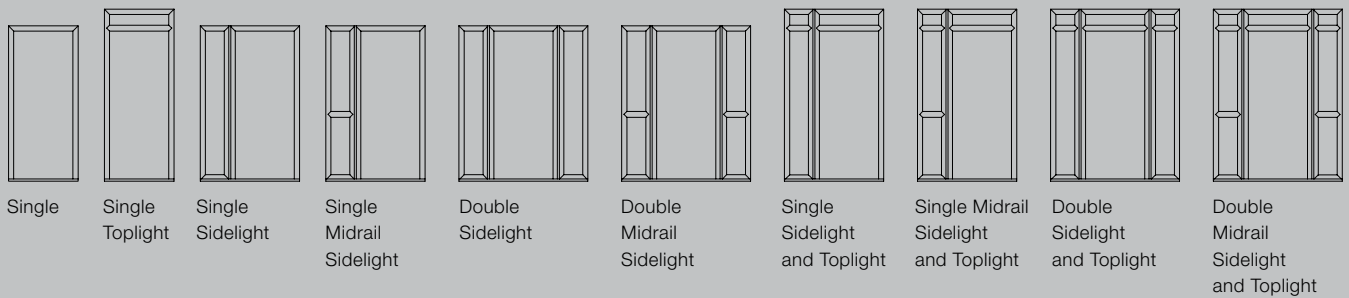

Single Single Toplight Single Sidelight Single Midrail Sidelight Double Sidelight Double Midrail Sidelight Single Sidelight and Toplight Single Midrail Sidelight and Toplight Double Sidelight and Toplight Double Midrail Sidelight and Toplight

Maximum and minimum sizes without frame extenders

Single Doorsets	Low aluminium threshold		4 sided PVCU frame	
	No Still	Standard PVCu Still	No Still	Standard PVCu Still
Min height (mm)	1972	2002	2001	2031
Max height (mm)	2072	2102	2101	2131
Standard Door				
Min. Width	836	836	836	836
Max. Width	1002	1002	1002	1002
TR2J / TR94				
Min. Width	836	836	836	836
Max. Width	1002	1002	1002	1002
TR36 / TR80				
Min. Width	774	774	774	774
Max. Width	850	850	850	850

Foiled Frame Standard colours*

Internal white only. Hinged open in only

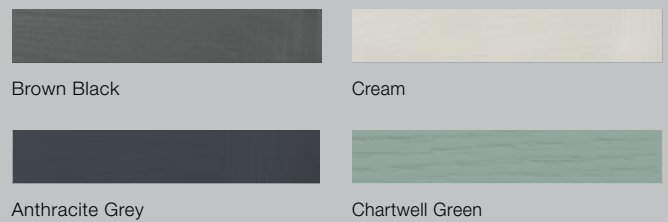

Woodstain Colours

Internal colour matched or white

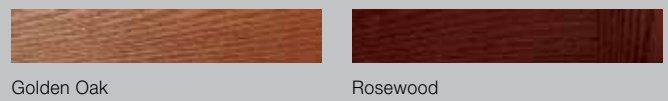

* Due to the difference of materials we cannot guarantee an exact match in colour or texture of the finished doors in foiled frames.

Side Panels and Toplights

For added individuality or to replace your doorset like for like, we offer fully glazed sidelights or toplights, or composite sidepanels to match the door. These are all available as single or as a pair in a variety of styles.

Matching Side Panels

439 mm including couples

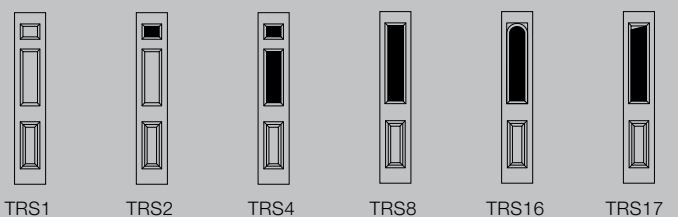

Midrail Sidelight

Toplight



Double Composite Sidepanels

GLASS RANGE

For maximum light into your home

We offer a range of clear and patterned obscure glass options, allowing privacy and maximum light into your home.

Clear Glass Patterns

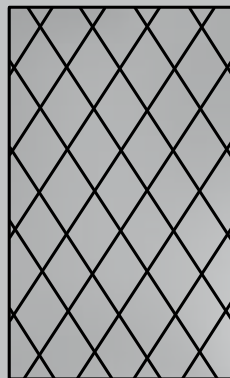

Diamond lead

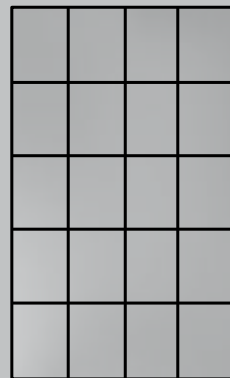

Square lead

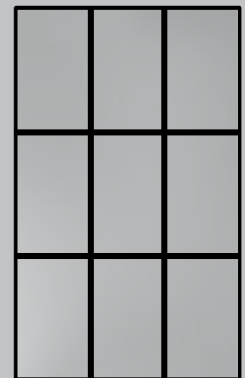

Georgian grid*

Standard range

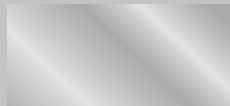

Clear



Cotswold



Stippolyte

Specialised range



Arctic



Autumn



Chantilly



Charcoal Sticks



Contora



Digital



Everglade



Flemish



Florielle



Mayflower



Minster



Oak



Pelerine



Satin



Taffeta



Warwick

* Outside colours for the Georgian grid are only available in Red, Blue, Green, Cream, White, Rosewood and Golden Oak. Inside colours are always in White.

They fit perfectly

All of our glazings are tailored to the specific door style, ensuring that every door is personalised to each owner.

Traditional Etch: in Grey only



Retro: in 4 colours



Diamonds: in clear bevelled glass and in 4 colours



Prairie: in clear bevelled glass



Flair: in clear bevelled glass



DECORATIVE GLAZING OPTIONS

Gibson:
in clear bevelled glass



Linear:
in etched glass and clear cut lines

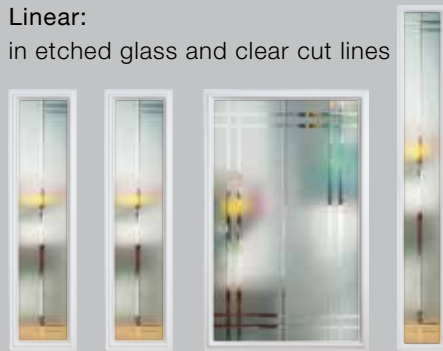

Diamonds cut:
in clear bevelled glass



Reflections:
in clear bevelled glass



Elegance:
in clear bevelled glass

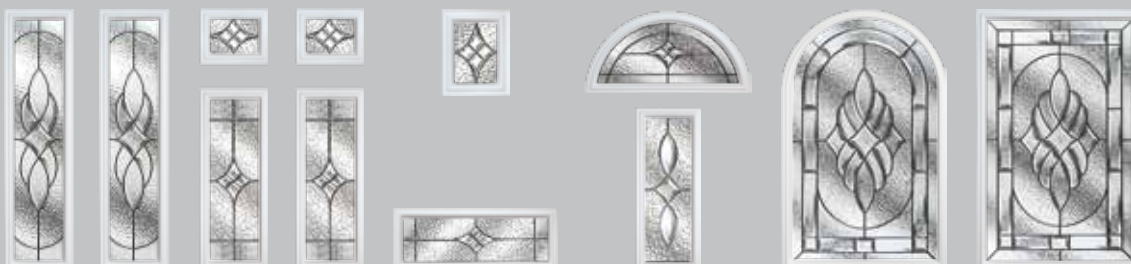

French:

in clear bevelled glass and in 4 colours



Onyx



Sapphire



Emerald



Ruby

Touch of Privacy:
for white doors only



Harmony:

in clear bevelled glass and in 3 colours

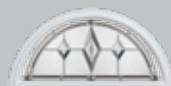

Silver Grey



Chartwell Green



Larkspur Blue

Clear lines:
in clear glass



Satin lines:
in satin backing



Panache:
in clear glass

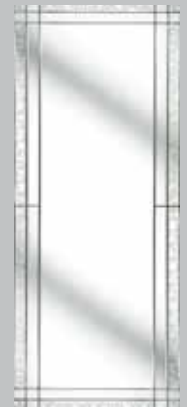

Simplicity:

in clear bevelled glass

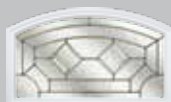

Victoriana:

in 4 colours

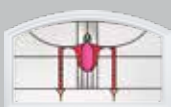

Blue



Green



Red



Purple

Dorchester:

in Green/Blue

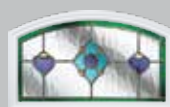

Numbers:

The border on the numbers is available in the five colours shown and in any two combinations.



Amber



Clear



Dark Blue



Deep Red



Dark Green

ACCESSORIES

Whatever you want!

Personalising your composite exterior door from Hörmann doesn't end with the style, colour and finish. There is an extensive range of high quality accessories to choose from to suit the overall look of your home. Our corrosion resistant handles, letterplates, knockers, numerals and eyeviewers have been manufactured to an extremely high standard of performance.

Contemporary steel bar handles

- Brushed stainless steel bar handles
- Contemporary handles that create a stunning entrance door
- Austenitic stainless steel construction
- Ultimate corrosion resistance
- All our bar handles are through fixed to a matching internal handle
- Matching escutcheon and letterplate available

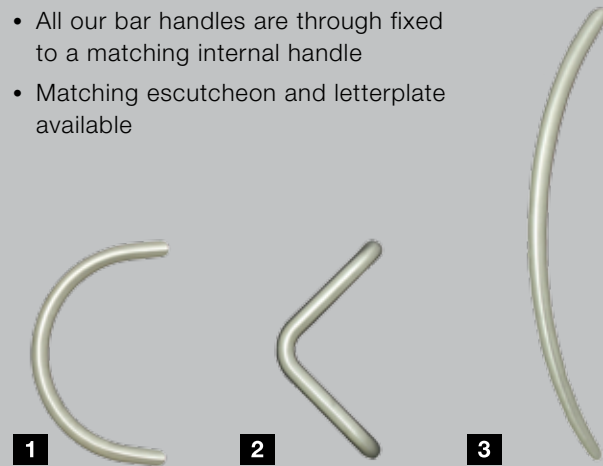

- 1 D Handle
- 2 V Handle
- 3 Bow Handle
- 4 Inline 60 (60 cm)
- 5 Inline 120 (120 cm)
- 6 Inline 180 (180 cm)
- 7 Offset 60 (60 cm)
- 8 Offset 120 (120 cm)
- 9 Offset 180 (180 cm)
- 10 Letterplate
- 11 Ingot Knocker
- 12 Escutcheon

Contemporary matching hardware



	Lever / lever handles	Lever / Pad handles	Letterplates	Knockers	Numerals*
Gold					
Chrome					
Brushed Stainless					
Black					
White					

Hinges



Brown



White



Tan

Security chains



Gold



Chrome

* Numerals available from 0-9 and A-D only

Security as standard

Our doors are fitted with high security multi-point locking systems as standard. These locks meet the requirements of PAS 23/24 and are tested in accordance with BS EN ISO 9001 Quality Assurance. We also supply a 'split spindle' option which further enhances security. The door locks on the latch as soon as the door is shut and requires a key to unlock it.

To take the security of our doors to an even higher level, we also fit our specially designed triple dogbolt system as standard. This involves two sets of triple hinge bolts that secure the door to the frame, protecting you against intruders. Through our design we aim to make fitting composite doors easier.



Viewed from outside

Standard range

1 Triple Dogbolts

- 2 sets of triple dogbolts supplied as standard on all Hörmann composite doors
- Designed to complement our existing high security multi-point lock
- Exclusive to Hörmann

2 Euro cylinder

Delivered with 3 keys as standard. With emergency and hazard function, i.e. the door lock can still be operated when the key is inserted on the inside.

Specialised range

3 AV2 Multipoint Autolock

Designed to provide homeowners with instant security by automatically engaging two solid high-tensile steel hooks and central latch every time the door is shut.

Standard 24 mm wide keeps with dust boxes, auto latch strike plate and off-set screw fixing for enhanced security.

4 Thunderbolt Heritage Lock

Designed to complement our traditional or modern doors featuring shoulder height locking.

5 Security cylinder

The security door cylinder incorporates an anti-snap facility to protect your door and keep your home secured.

6 Thumb-turn cylinder

The standard and security cylinders are available with an optional thumb-turn. The door can be locked and unlocked from the inside without the use of a key.

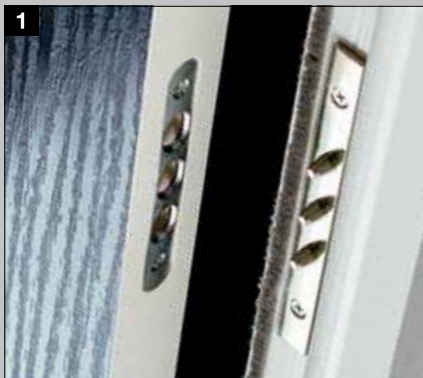

THERMOCOMP

Fire Door range

Hörmann Fire Doors are tested by independent fire laboratories and are available with a range of ironmongery options. Our Fire Doors have been tested to meet the requirements for a 30 minute fire resistance (FD30S) as required for flat entrance doors and most other fire door situations.

Hörmann Fire Doors are available in a range of PVCu or softwood frames as pre-hung units complete with intumescent fire seals, smoke seals and sound seals to meet Approved Documents B&E of the Building Regulations.



Style FNG01*
Door leaf in Standard colour Signal Red, frame in Traffic White, Chrome lever/lever handle



Style FNG02*
Door leaf in Standard colour Traffic White, frame in Traffic White, Chrome lever/lever handle



Style FNG04*
Door leaf in Standard colour Traffic White, frame in Traffic White, fire-rated glazing, Chrome lever/lever handle



Style FNG09*
Door leaf in Standard colour Steel Blue, frame in Traffic White, Chrome lever/lever handle and fire-rated letterplate



Style FNG18*
Door leaf in Standard colour Traffic White, frame in Traffic White, Chrome lever/lever handle



Style FNG81
Door leaf in Standard colour Jet Black, frame in Traffic White, fire-rated glazing, Chrome lever/lever handle and fire-rated letterplate



Style FNG1H
Door leaf in Standard colour Pine Green, frame in Traffic White, Chrome lever/lever handle and fire-rated letterplate



Style FNG22
Door leaf in Standard colour Traffic White, frame in Traffic White, fire-rated glazing, Chrome lever/lever handle and fire-rated letterplate

* Some designs also available in Steel on request.

Please contact the Technical Department if you require further advice or information.

Features and Benefits

- Available primed for on-site painting or prefinished in a choice of five standard colours
- Meet Secured by Design standards
- Durable construction that does not warp, bow or split
- Excellent sound and thermal performance
- Acoustic seals to meet Part E of Building Regulations
- GRP Fibrecolour variants available in Jet Black, Steel Blue, Pine Green, Signal Red and Traffic White
- Glazed options available

Ironmongery

- Multipoint locking system
- Euro profile key/thumb-turn cylinder
- Steel butt hinges as standard

Additional Items

- 180° eye viewer
- Fire rated letterplate
- Door chain

Self-Closing Options

- Concealed door closer.
- Overhead door closer.

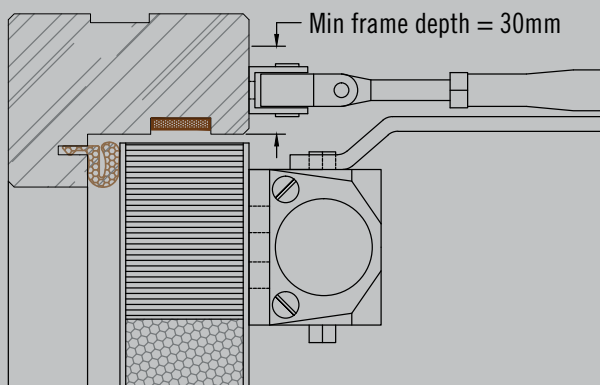

Overhead Closer detail timber frame

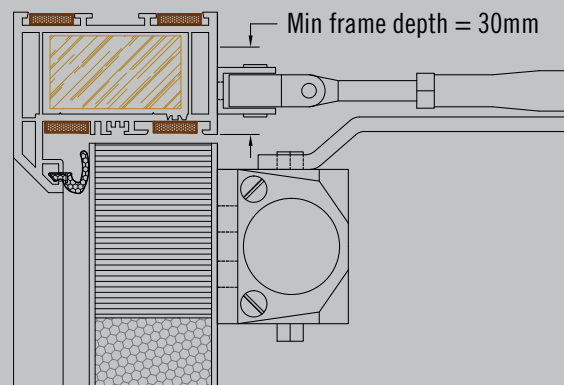

Overhead Closer detail PVCu frame

Minimum frame head depth required for fitting of overhead closer.

1 Fire resistant glazing

Fire resistant glass is available as a double glazed unit with the inside pane laminated and the external pane in Pilkington Pyroshield2 Georgian wire glass (rating E30). Where obscure glass is required then the laminated panel is supplied as stippolyte obscure.

2 Self closing devices

Fire doors are usually required to have self closing devices fitted. Hörmann recommends the use of overhead type controlled closers to EN 1154 for this purpose. The closers used are rated for the weight and size of the doors supplied. Jamb type concealed closers can be supplied on request but Hörmann accepts no responsibility for the ability of this type of device to fully close a door.

The ability of any closer to close a door is dependent on the free movement of air on both the opening side and closing side of the door. Overhead closers require a minimum of 30 mm fixing space at the head of the frame and also clearance at the reveal to allow the door to open to 90°. Please ensure your build detail allows sufficient space.

3 Fire Door Frame options

- a: Single
- b: Single Toplight
- c: Single Midrail Sidelight

4 Fire Rated letterplate

