

Technical manual

Status 01.07.2022

High-speed doors



Hörmann high-speed doors

A broad programme for inside and outside

From low-cost design models to secure night doors

Hörmann high-speed doors are distinguished by high-quality materials and secure long-term functionality. High-speed doors are used indoors and outdoors. High-speed doors optimise the flow of traffic, improve the room climate and save energy.

Hörmann high-speed doors comply with strict European safety requirements.



Contents

Contents	Page
Turbo spiral doors	
Technical data	4–5
HS 5040 TurboLux / HS 5040 TurboLux S	6
Spiral doors and high-speed sectional doors	
Technical data	8–9
HS 7030 PU 42	10–12
HS 5012 PU 42 S	13–15
HS 5015 PU N 42	16
HS 5015 PU H 42	17
HS 6015 PU V 42	18
Curtain design	19
Technical data	20–21
Curtain design	22
HS 5015 Acoustic H	23
HS 7030 Acoustic	24–26
HS 6015 Acoustic V	27
Iso Speed Cold H 100	28
Iso Speed Cold V 100	29
High-speed doors with flexible door leaf	
Internal doors	
Technical data	30–31
V 4020 SEL Alu-R	32–33
V 4008 SEL	34–35
V 5015 SEL	36–38
V 5030 SEL	39–44
External doors	
Technical data	46–47
V 6030 SEL	48–51
V 6020 TRL	52–54
V 10008	55–56
Internal doors for special applications	
Technical data	58–59
V 4015 Iso L	60–61
V 2515 Food L	62
V 2012	63
V 3015 Clean	64
Internal doors for individual requirements	
Technical data	66–67
V 5030 MSL	68–71
V 3009 conveyor	72–74
V 6030 Atex	75–77

No part may be reproduced without our prior permission.
 All rights reserved
 All dimensions in mm
 Subject to design changes

Turbo spiral doors

Technical data

Use	Internal door	
	External door	
Door sizes	Maximum width LDB	
	Maximum height LDH	
Speed	FU control, 3-phase	Max. opening approx. m/s
	FU control, 1-phase	Max. opening approx. m/s
		Max. closing approx. m/s
Security features	EN 13241.1	
Wind load resistance	EN 12424	Wind class 2
		Wind class 4
Door construction	Self-supporting	
Door leaf counterbalance	Springs	
	Belt mechanism with counter weights	
Door leaf	polycarbonate	
	Section height in mm	
Door leaf coating in selected colours		
Operator and control	Frequency converter	
	Connecting voltage	1-phase, 1 – 230 V, N, PE
		3-phase, 3 – 400 V, N, PE
	Open-Stop-Close button	
	Main switch with all-pole switch-off	1-phase
		3-phase
	Emergency-off button	1-phase
		3-phase
	Fuse protection	1-phase, 3-phase
	Protection category for control	
	Protection category for operator	
	Closing zone monitoring	Safety light grille IP 67
	Hold-open phase, in sec.	
	Electronic limit switch Multiturn	
Emergency opening	Emergency hand chain	
	Secured release	
Volt-free contacts		
Plug-in control wiring		

● = Standard

○ = Optional

HS 5040 TurboLux	HS 5040 TurboLux S
●	●
●	●
5000	5000
5000	5000
3,5	—
—	> 4.0
1,0	1,0
●	●
●	●
●	●
—	—
—	●
●	—
1,5	1,5
550	550
0	0
●	●
—	●
●	—
●	●
—	0
●	—
—	0
●	—
16 A, slow-acting	16 A, slow-acting
IP 65	IP 65
IP 54	IP 54
●	●
1–200	1–200
●	●
●	●
—	●
3	3
●	●

Spiral doors and high-speed sectional doors

HS 5040 TurboLux / HS 5040 TurboLux S

Without / with cladding

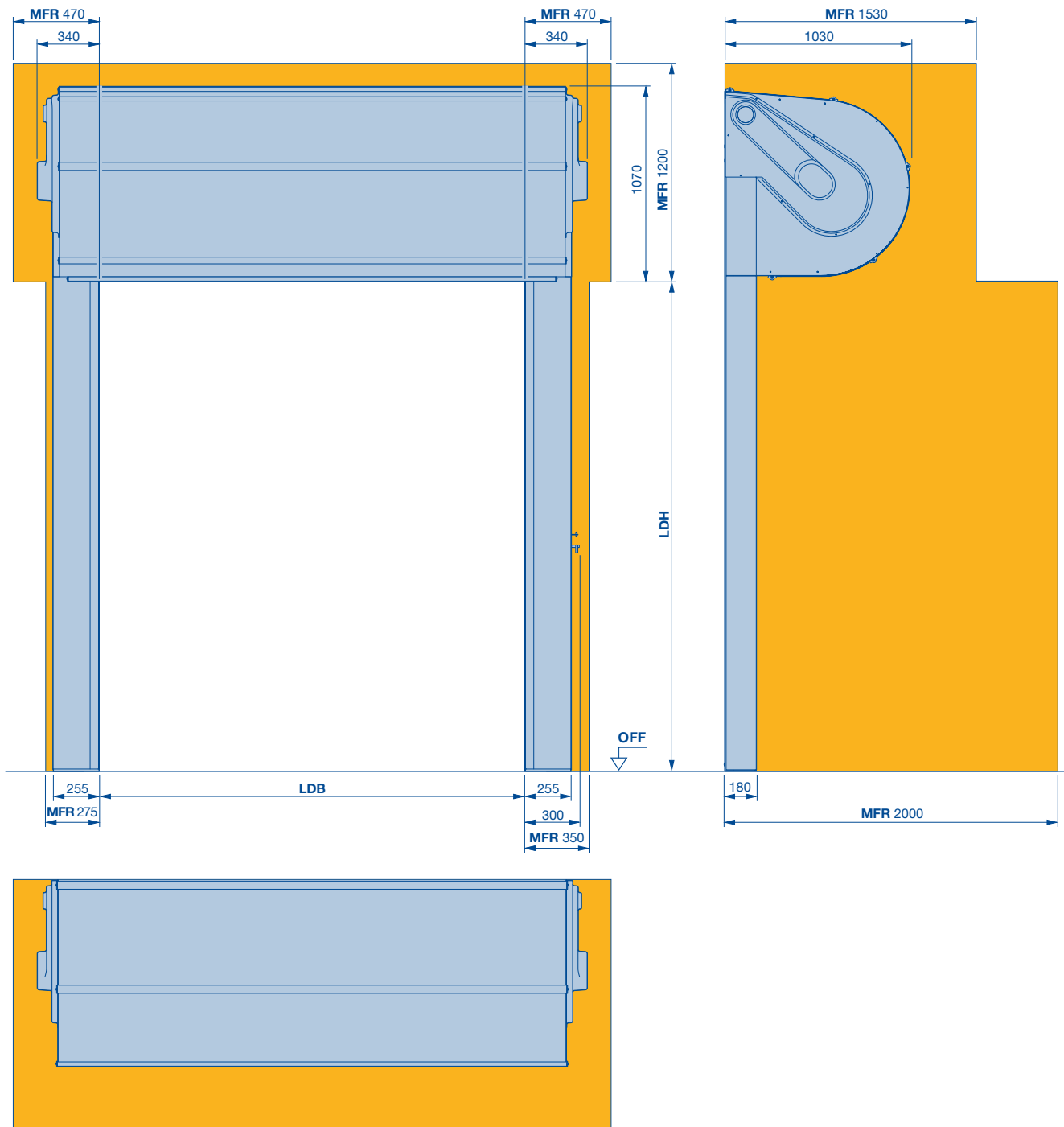

BPA Space required to fit and dismantle the operator

LDB Clear passage width

LDH Clear passage height

MFR Space for fitting the door

Notes

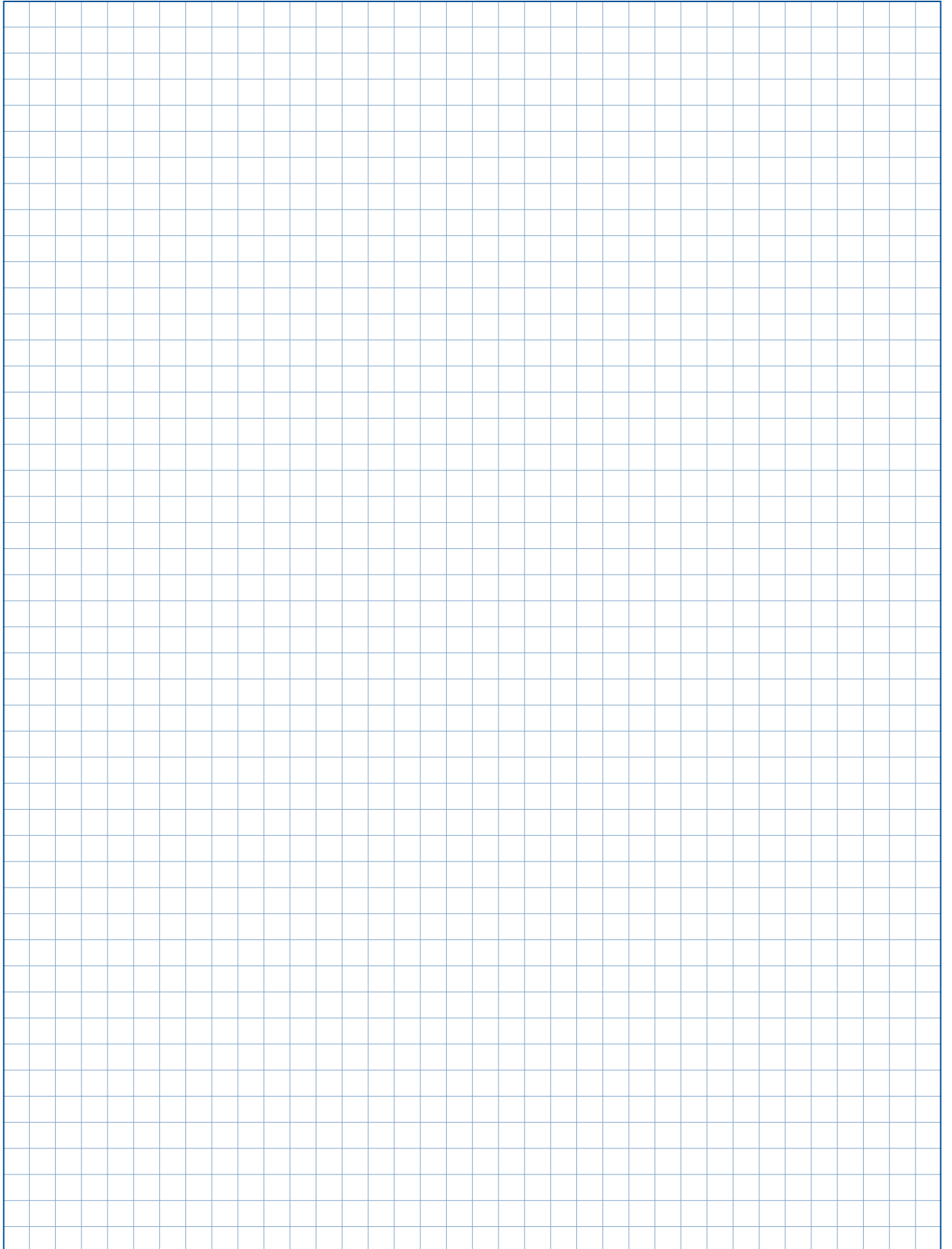

Spiral doors and high-speed sectional doors

Technical data

Use	Internal door	
	External door	
Door sizes	Maximum width LDB	
	Maximum height LDH	
Speed	FU control, 3-phase	Max. opening approx. m/s Max. closing approx. m/s
Security features	EN 13241.1	
Wind load resistance	EN 12424	Door width ≤ 5000 mm Door width > 5000 mm ≤ 6000 mm Door width > 6000 mm
Thermal insulation	EN 13241-1, ISO 12567-1	Door size 4000 × 4000 mm, without glazing, with ThermoFrame
Resistance to water penetration	EN 12425	
Air permeability	EN 12426	
Acoustic insulation	EN ISO 717-1, EN ISO 10140-1, EN ISO 10140-2	
Break-in resistance	DIN / TS 18194	
Door construction	Self-supporting	
Door leaf counterbalance	Chain mechanism and springs Belt mechanism and counter weights	
Door leaf	Steel sandwich construction, PU-foamed Sections with thermal break Depth in mm Section height in mm	
Door leaf material and surface	Exterior and interior surface Standard colour Wet coated, RAL to choose Aluminium rail windows, anodised aluminium E6 / EV 1	
Glazing	Double synthetic panes Glazing with thermal break	
Ventilation grilles	Ventilation cross-section 54%	
ThermoFrame		
Operator and control	Frequency converter	
	Connecting voltage	1-phase, 1 – 230 V, N, PE Optionally up to max 3000 × 3000 mm 3-phase, 3 – 400 V, N, PE
	Open-Stop-Close button	
	Main switch with all-pole switch-off	1-phase, optionally up to max 3000 × 3000 mm 3-phase
	Emergency-off button	1-phase, optionally up to max 3000 × 3000 mm 3-phase
	Fuse protection	1-phase, 3-phase
	Protection category for control	
	Protection category for operator	
	Closing zone monitoring	Safety light grille IP 67
	Hold-open phase, in sec.	
	Electronic limit switch DES	
Emergency opening	Emergency crank handle Emergency hand chain UPS in plastic cabinet (200 × 400 × 200) for FU control 230 V, 1-phase (up to 9 m ² on request)	
Volt-free contacts		
Plug-in control wiring		

● = Standard

○ = Optional

HS 7030 PU 42	HS 5012 PU 42 S	HS 5015 PU N 42	HS 5015 PU H 42	HS 6015 PU V 42
●	●	●	●	●
●	●	●	●	●
6500	5000	5000	5000	6500
6500	5000	6500	6500	6500
1,5 – 2,5	1,2	1,5 – 2,5	1,5 – 2,5	1,5 – 2,5
0,5	0,5	0,5	0,5	0,5
●	●	●	●	●
Class 5	Class 5	Class 5	Class 5	Class 5
Class 4	—	—	—	Class 4
Class 2	—	—	—	Class 2
1.04 / W/(m²K)	1.04 / W/(m²K)	1.04 / W/(m²K)	1.04 / W/(m²K)	1.04 / W/(m²K)
Class 1	Class 1	Class 1	Class 1	Class 1
Class 2	Class 2	Class 2	Class 2	Class 2
26	26	26	26	26
RC2	—	—	—	—
—	—	—	—	—
●	—	●	—	—
○	—	—	●	●
●	●	●	●	●
●	●	●	●	●
42	42	42	42	42
250	250	250	250	250
Micrograin / Stucco	Micrograin / Stucco	Micrograin / Stucco	Micrograin / Stucco	Micrograin / Stucco
RAL 9006	RAL 9006	RAL 9006	RAL 9006	RAL 9006
○	○	○	○	○
○	○	○	○	○
○	○	○	○	○
—	—	—	—	—
○	○	○	○	○
○	○	○	○	○
●	●	●	●	●
○	—	○	○	○
●	●	●	●	●
●	●	●	●	●
○	—	○	○	○
●	●	●	●	●
○	—	○	○	○
●	●	●	●	●
16 A, slow-acting	16 A, slow-acting	16 A, slow-acting	16 A, slow-acting	16 A, slow-acting
IP 65	IP 65	IP 65	IP 65	IP 65
IP 54	IP 54	IP 54	IP 54	IP 54
●	●	●	●	●
1 – 200	1 – 200	1 – 200	1 – 200	1 – 200
●	●	●	●	●
—	—	—	—	—
●	●	●	●	●
○	—	○	—	○
3	3	3	3	3
●	●	●	●	●

Spiral doors and high-speed sectional doors

HS 7030 PU 42

With PU insulating panels

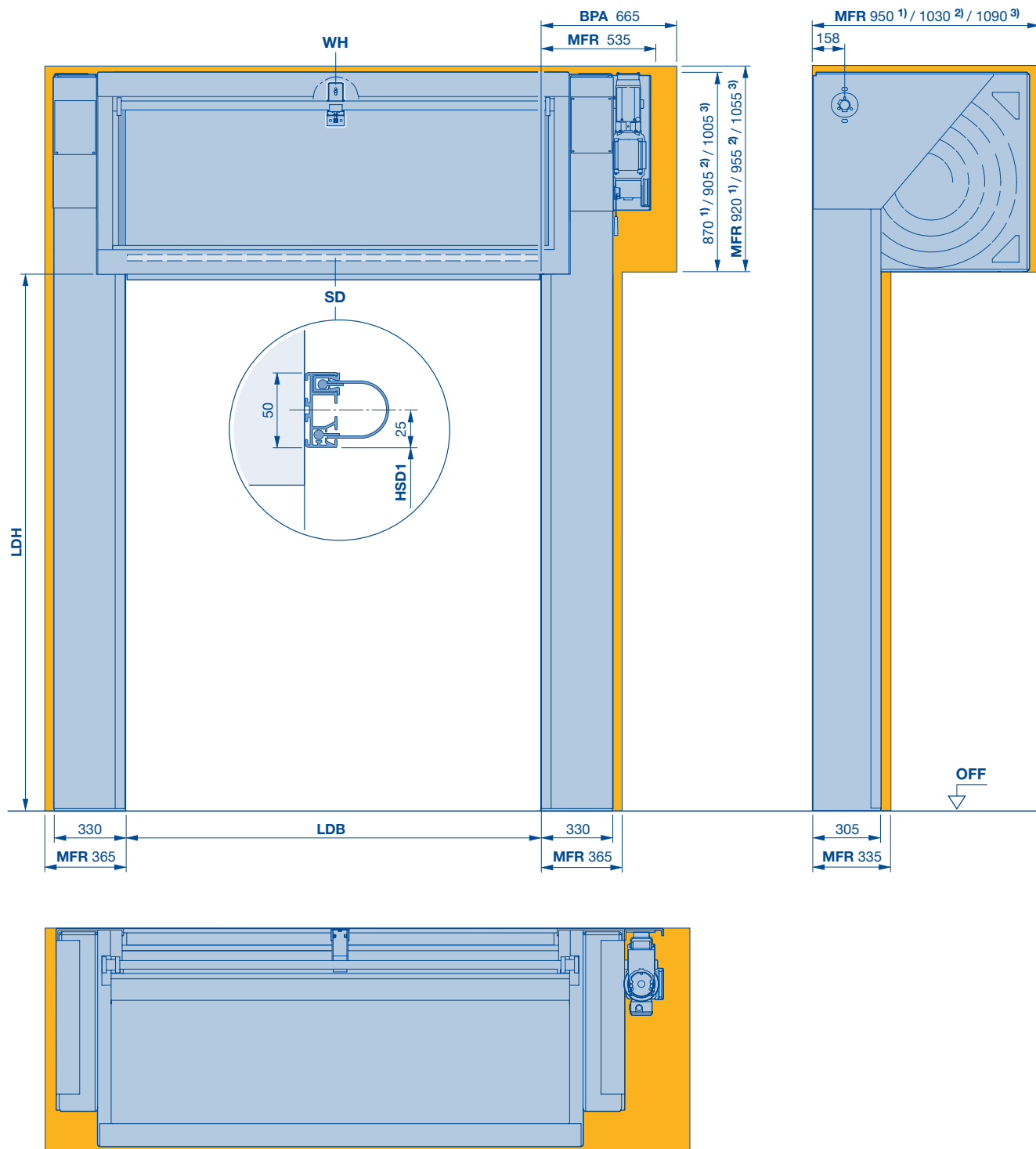

- | | |
|--|---------------------------------------|
| 1) LDH ≤ 4500 | LDB Clear passage width |
| 2) LDH > 4500 – ≤ 5500 | LDH Clear passage height |
| 3) LDH > 5500 – ≤ 8000 | MFR Space for fitting the door |
| BPA Space required to fit and dismantle the operator | SD Lintel seal |
| HSD1 Height of the lintel seal (dimension on request) | WH Shaft support |
| | LDB > 3500 mm (1 ×) |
| | LDB > 5000 mm (2 ×) |

Spiral doors and high-speed sectional doors

HS 7030 PU 42

With PU insulating panels

Full cladding, straight

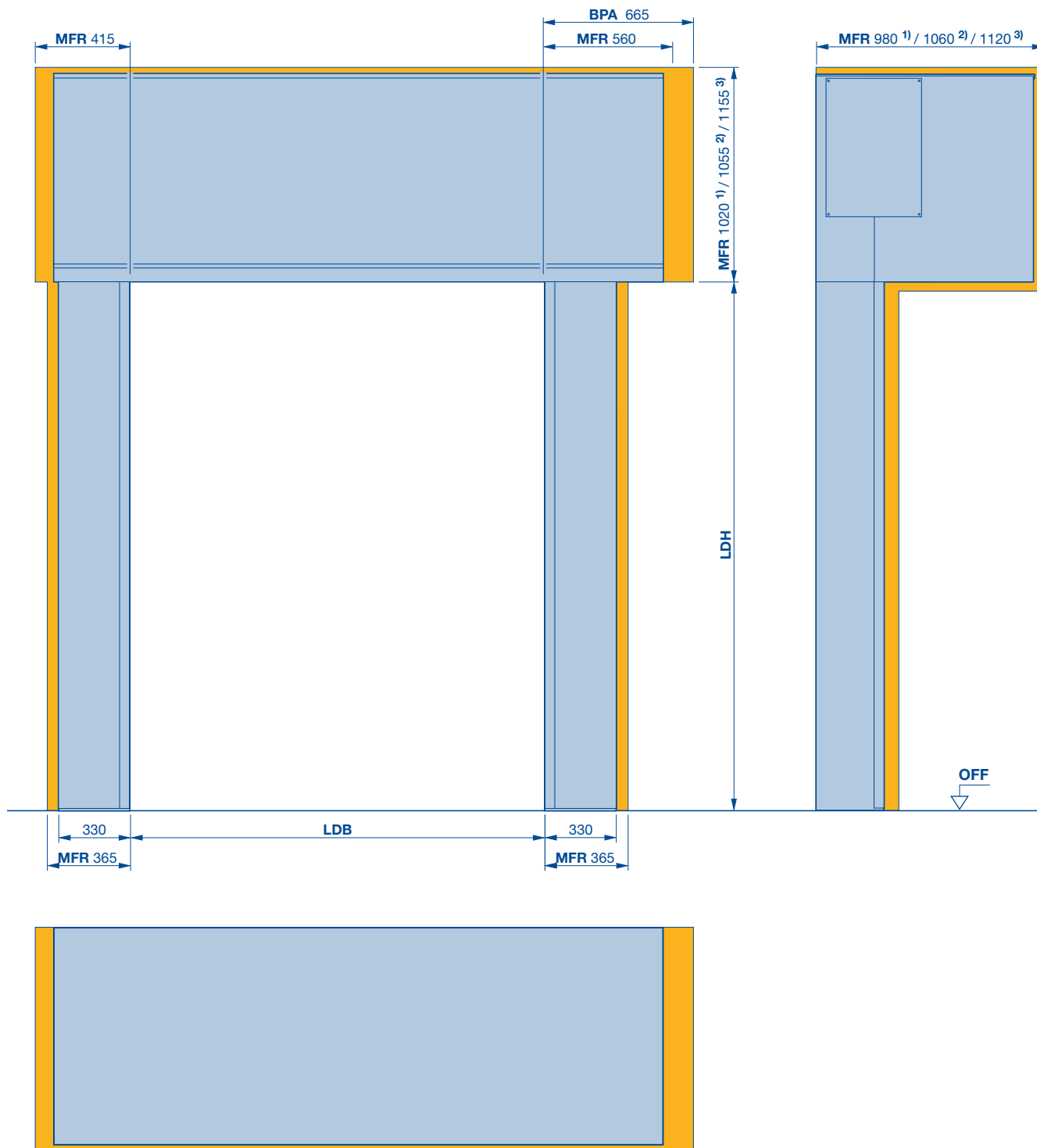

- 1) LDH ≤ 4500
- 2) LDH > 4500 – ≤ 5500
- 3) LDH > 5500 – ≤ 8000
- BPA** Space required to fit and dismantle the operator
- LDB** Clear passage width
- LDH** Clear passage height
- MFR** Space for fitting the door

Spiral doors and high-speed sectional doors

HS 7030 PU 42

With PU insulating panels

Full cladding, chamfered

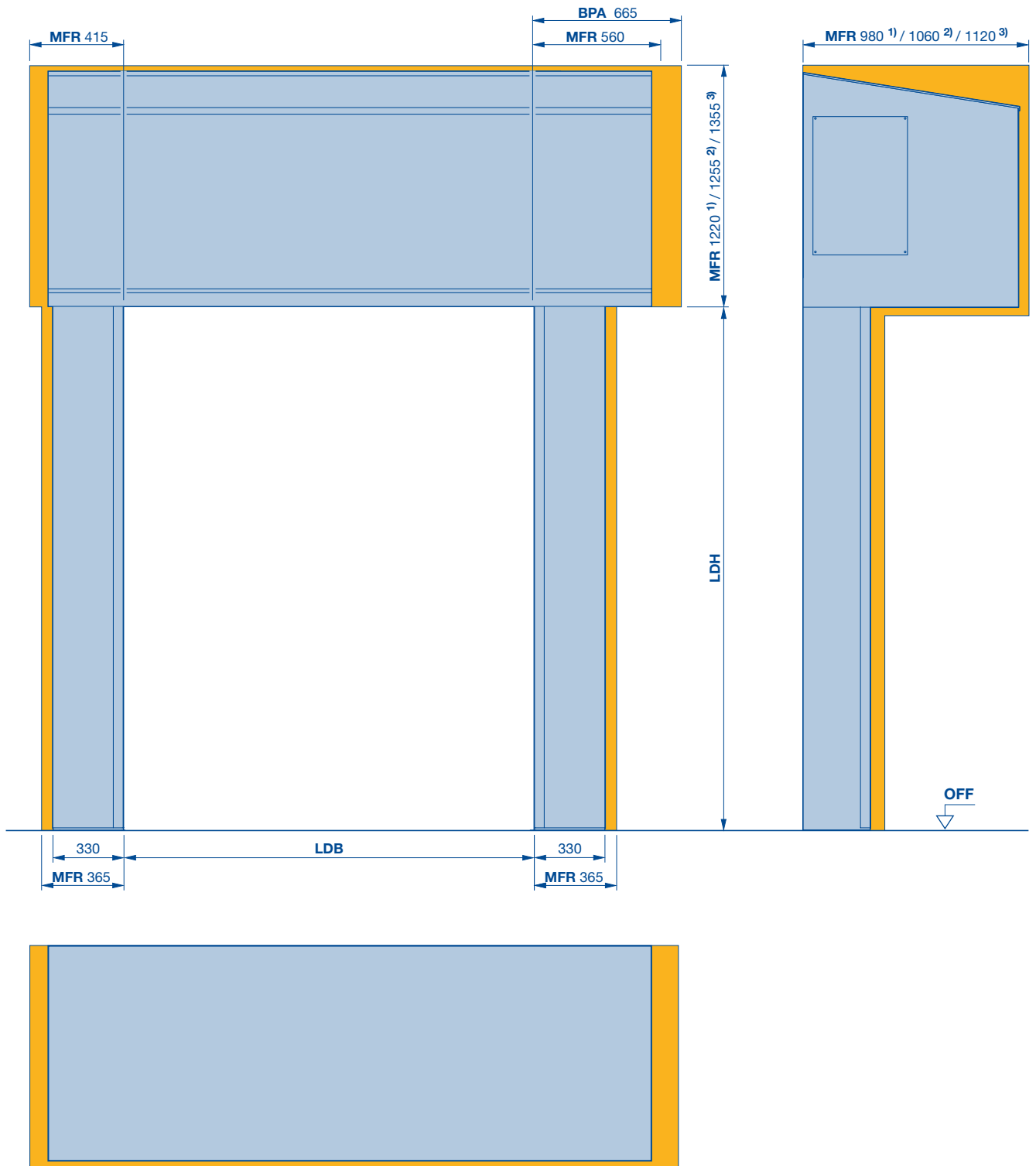

1) LDH ≤ 4500

2) LDH > 4500 – ≤ 5500

3) LDH > 5500 – ≤ 8000

BPA Space required to fit and dismantle the operator

LDB Clear passage width

LDH Clear passage height

MFR Space for fitting the door

Spiral doors and high-speed sectional doors

HS 5012 PU 42 S

With non-contact roll-up technology and narrow side elements

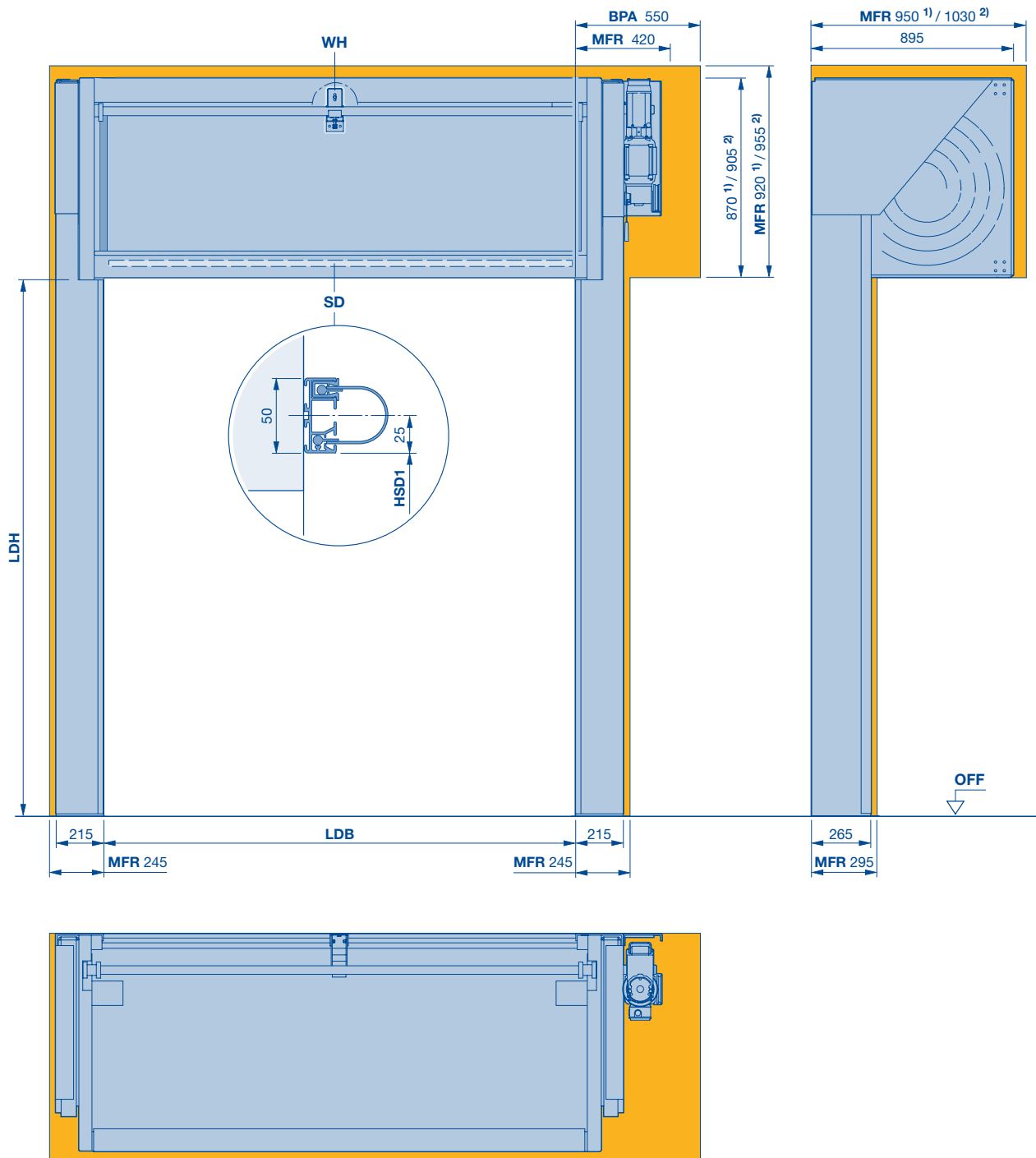

1) LDH ≤ 4500

2) LDH > 4500

BPA Space required to fit and dismantle the operator

HSD1 Height of the lintel seal (dimension on request)

LDB Clear passage width

LDH Clear passage height

MFR Space for fitting the door

SD Lintel seal

WH Shaft support
LDB > 3500 mm (1 ×)

Spiral doors and high-speed sectional doors

HS 5012 PU 42 S

With non-contact roll-up technology and narrow side elements

Full cladding, straight

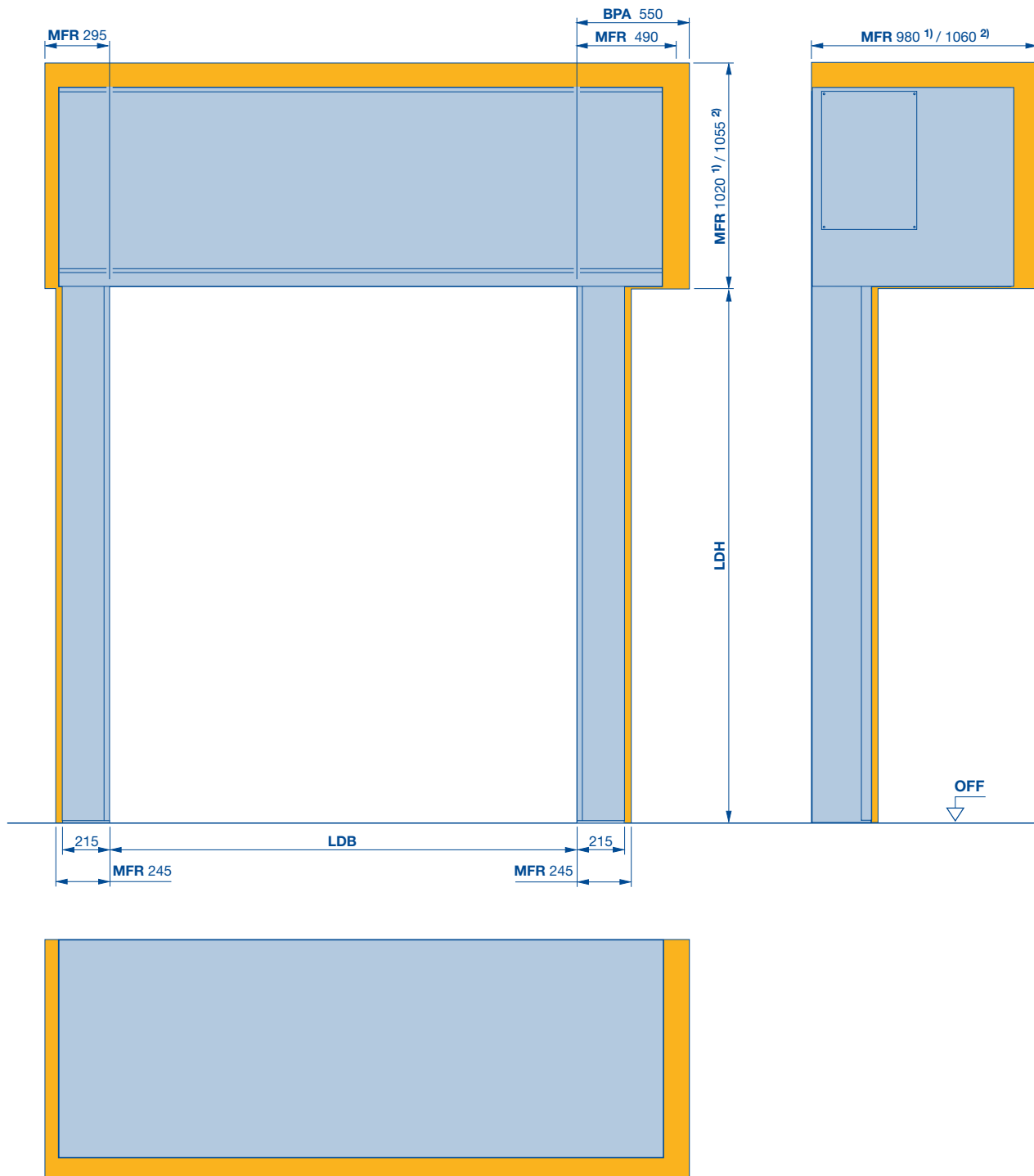

1) LDH ≤ 4500

2) LDH > 4500

BPA Space required to fit and dismantle the operator

LDB Clear passage width

LDH Clear passage height

MFR Space for fitting the door

Spiral doors and high-speed sectional doors

HS 5012 PU 42 S

With non-contact roll-up technology and narrow side elements

Full cladding, chamfered

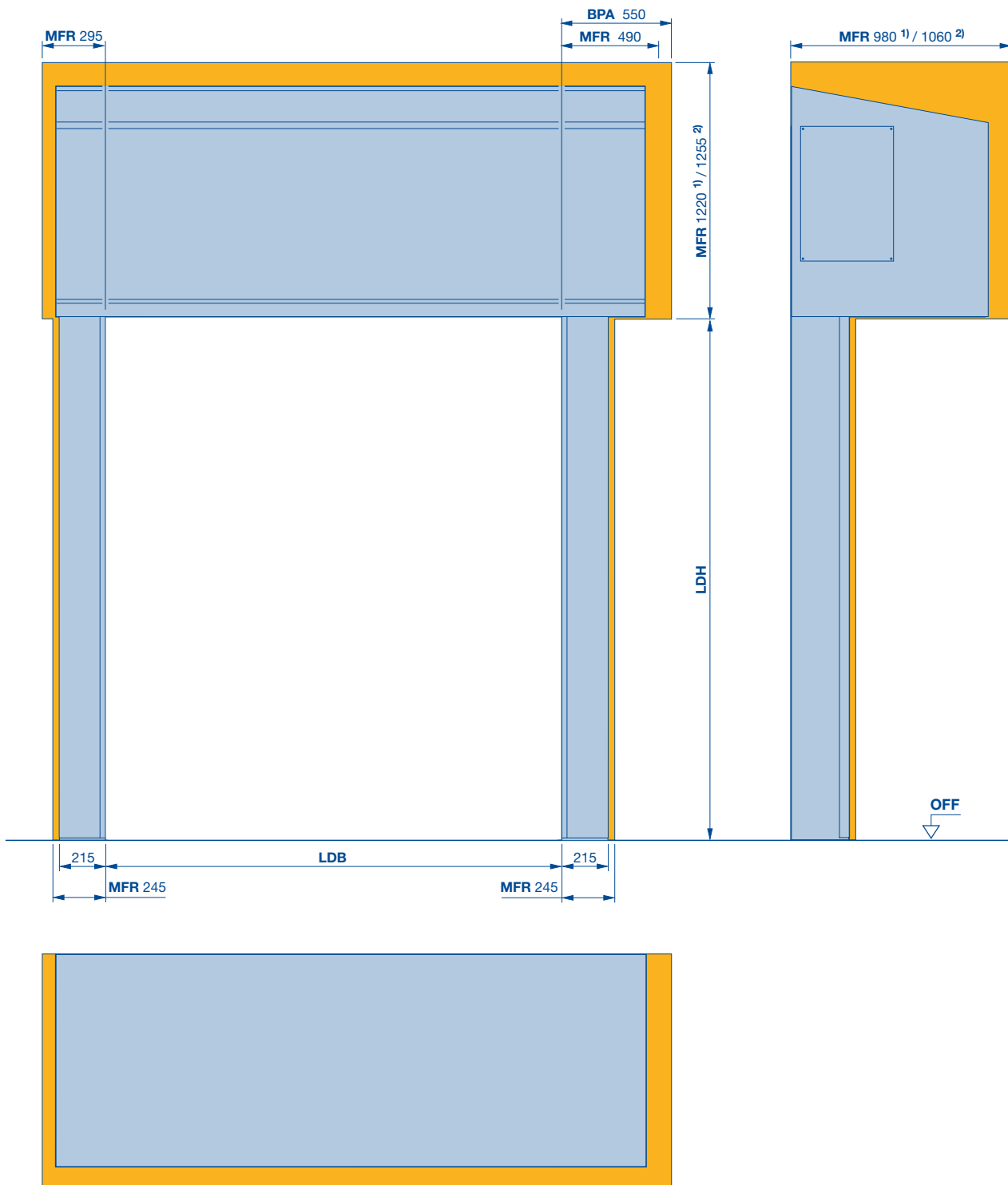

1) LDH ≤ 4500

2) LDH > 4500

BPA Space required to fit and dismantle the operator

LDB Clear passage width

LDH Clear passage height

MFR Space for fitting the door

Spiral doors and high-speed sectional doors

HS 5015 PU N 42

With PU insulating panels

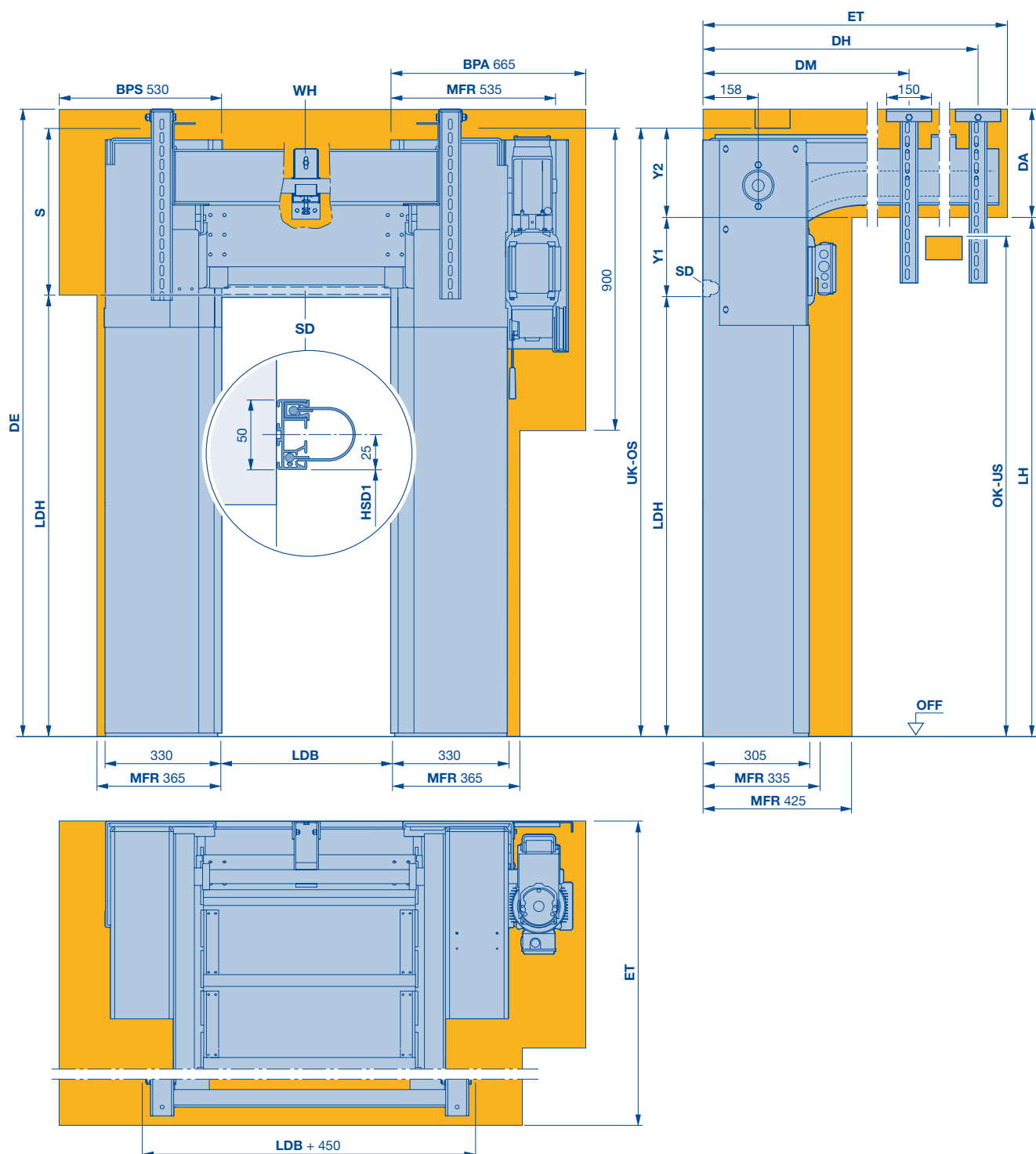

BPA	Space required to fit and dismantle the operator
BPS	Space required to fit and dismantle the side cover
DA	Distance to ceiling $DE - LDH - S + Y2$
DE	Ceiling height $DA + LDH + S - Y2$
DH	Rear ceiling anchor $ET - 120$
DM	Centre ceiling anchor 960 ($ET > 1250$)
ET	Minimum distance back $2 \times LDH - (LDH + S) + 1000$ (min 1250)

HSD1	Height of the lintel seal (dimension on request)
LDB	Clear passage width
LDH	Clear passage height
LH	Track height $LDH + S - Y2$ (min. $LDH + Y1$)
MFR	Space for fitting the door
OK	Top edge
OS	Top interference contour

S	Required headroom at least 480, maximum 750
SD	Lintel seal
UK	Bottom edge
US	Bottom interference contour
WH	Shaft support
Y1	$LDH < 2500$: 170; $LDH \geq 2500$: 225
Y2	$LDH < 2500$: 310; $LDH \geq 2500$: 255

Spiral doors and high-speed sectional doors

HS 6015 PU V 42

With PU insulating panels

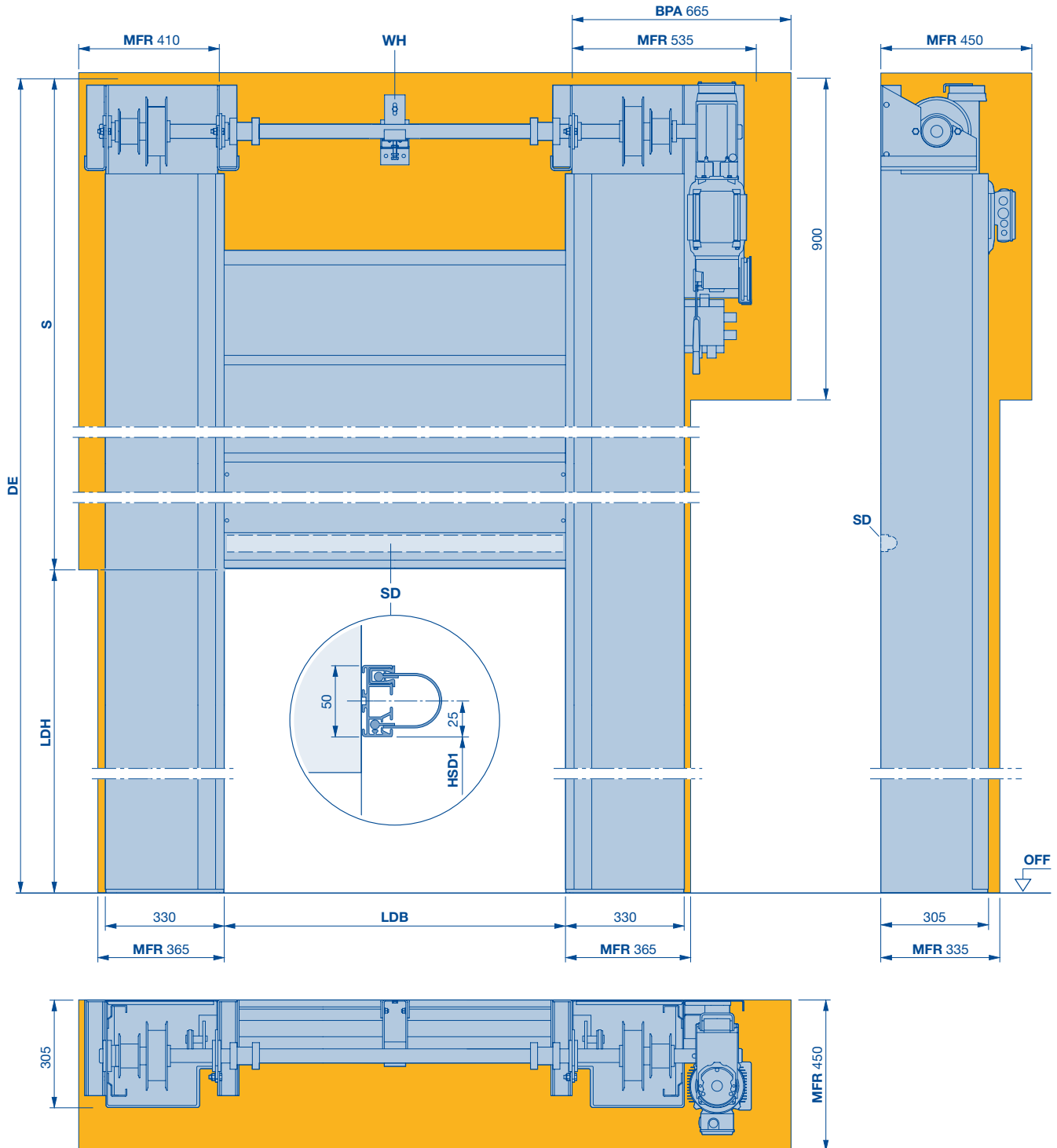

BPA Space required to fit and dismantle the operator

DE Ceiling height $2 \times LDH + 585$

HSD1 Height of the lintel seal (dimension on request)

LDH Clear passage height

LDB Clear passage width
 LDB > 3500 (1 x)
 LDB > 5000 (2 x)

MFR Space for fitting the door

S Required headroom at least $LDH + 585$

SD Lintel seal

WH Shaft support

Curtain design HS 5012 PU 42 S

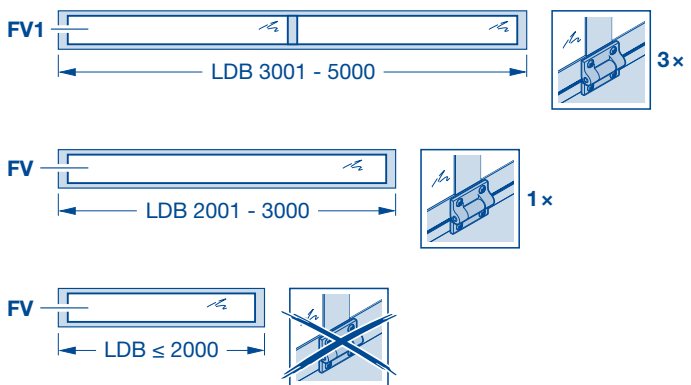
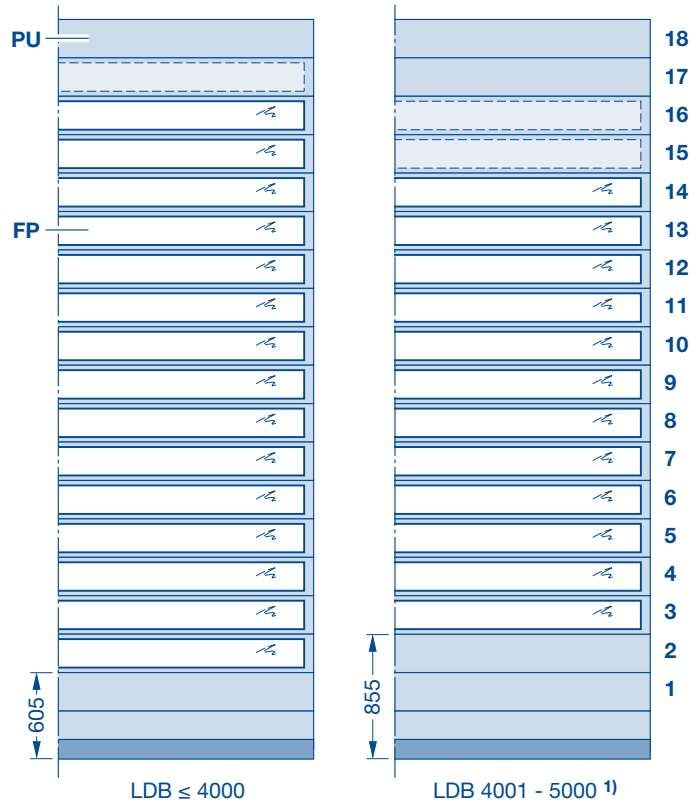
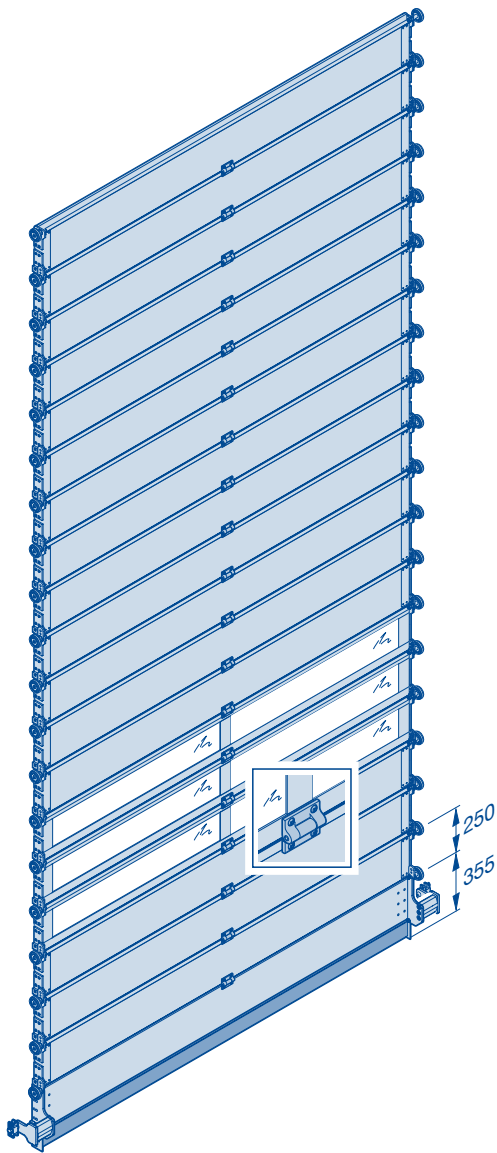

LDB Clear passage width
LDH Clear passage height
PU PU section 42 mm RAL9006

FP Window profile, E6 / C0 DURATEC synthetic glazing 26 mm
FV Window profile without connecting rib
FV1 Window profile with 1 connecting rib
FV2 Window profile with 2 connecting ribs

1) No more than 5 glazing profiles are possible from a clear height of 4500 mm.

Spiral doors and high-speed sectional doors

Technical data

Use	Internal door	
	External door	
Door sizes	Maximum width LDB	
	Maximum height LDH	
Speed	FU control, 3-phase	Max. opening approx. m/s
		Max. closing approx. m/s
Security features	EN 13241-1	
Wind load resistance	EN 12424	Door width ≤ 5000 mm
		Door width > 5000 mm ≤ 6000 mm
		Door width > 6000 mm
Thermal insulation	EN 13241-1, ISO 12567-1	Door size 4000 × 4000 mm, without glazing, with ThermoFrame
Resistance to water penetration	EN ISO 12425	
Air permeability	EN 12426	
Acoustic insulation	EN ISO 717-1, EN ISO 10140-1, EN ISO 10140-2	
Door construction	Self-supporting	
Door leaf counterbalance	Chain mechanism and springs	
	Belt mechanism and counter weights	
Door leaf	Steel sandwich construction, PU-foamed	
	Aluminium section E6 / E0, 5 mm UPVC and 30 mm PU foam	
	Sections with thermal break	
	Depth in mm	
	Section height in mm	
Door leaf material and surface	Exterior and interior surface	
	Standard colour	
	Wet coated, RAL to choose	
	Aluminium rail windows, anodised aluminium E6 / EV 1	
	Triple synthetic panes	
	Glazing with thermal break	
ThermoFrame		
Operator and control	Frequency converter	
	Connecting voltage	3-phase, 3 – 400 V, N, PE
	Open-Stop-Close button	
	Main switch, all-pole switch-off	3-phase
	Emergency-off button	3-phase
	Fuse protection	3-phase
	Protection category for control	
	Protection category for operator	
	Closing zone monitoring	Safety light grille IP 67
	Hold-open phase, in sec.	
	Electronic limit switch DES	
Emergency opening	Emergency crank handle	
	Emergency hand chain	
Volt-free contacts		
Plug-in control wiring		

● = Standard

○ = Optional

HS 5015 Acoustic H	HS 7030 Acoustic	HS 6015 Acoustic	Iso Speed Cold H 100 ¹⁾	Iso Speed Cold V 100 ¹⁾
●	●	●	●	●
●	●	●	—	—
5000	5000	5000	5000	5000
5000	5000	5000	5000	5000
1,5 – 2,5	1,5 – 2,5	1,5 – 2,5	2,0	2,0
0,5	0,5	0,5	0,5	0,5
●	●	●	●	●
Class 4	Class 4	Class 4	Class 5	Class 5
—	—	—	—	—
—	—	—	—	—
—	—	—	0.57 / W/(m²K)	0.57 / W/(m²K)
—	—	—	Class 3	Class 3
—	—	—	Class 3	Class 3
31	31	31	26	26
—	—	—	—	—
—	●	—	—	—
●	—	●	●	●
—	—	—	●	●
●	●	●	—	—
—	—	—	●	●
42	42	42	100	100
225	225	225	500	500
Aluminium E6	Aluminium E6	Aluminium E6	Stucco / Stucco	Stucco / Stucco
C0 anodised	C0 anodised	C0 anodised	RAL 9002	RAL 9002
O	O	O	O	O
—	—	—	—	—
—	—	—	—	—
—	—	—	—	—
O	O	O	●	●
●	●	●	●	●
●	●	●	●	●
●	●	●	●	●
●	●	●	●	●
●	●	●	●	●
16 A, slow-acting	16 A, slow-acting	16 A, slow-acting	16 A, slow-acting	16 A, slow-acting
IP 65	IP 65	IP 65	IP 65	IP 65
IP 54	IP 54	IP 54	IP 54	IP 54
●	●	●	●	●
1 – 200	1 – 200	1 – 200	1 – 200	1 – 200
●	●	●	●	●
—	—	—	—	—
●	●	●	●	●
3	3	3	3	3
—	—	—	●	●

Notes: ¹⁾

- If used in cold stores, a floor heating system is required in the area of the bottom seal. This prevents the bottom seal from freezing. This floor heating system must be provided on-site.
- The connecting lead for the heating must be laid separately from the control connecting lead. Both connecting leads must be produced in line with the identical technical requirements: at least 5 × 2.5 mm², 16 A and C-characteristic or K-characteristic. However, heating fuse additionally with a residual current circuit breaker 3 × 25 A / 0.03 A. This cable must be routed on-site up to the operator.
- It is also recommended to use an air curtain system in cold stores. The activated door air curtain keeps most moisture (steam) back. This means that the cold store loses less energy. Ice formation around the door is reduced. Consequential damage is minimised.

Curtain design HS PU 42

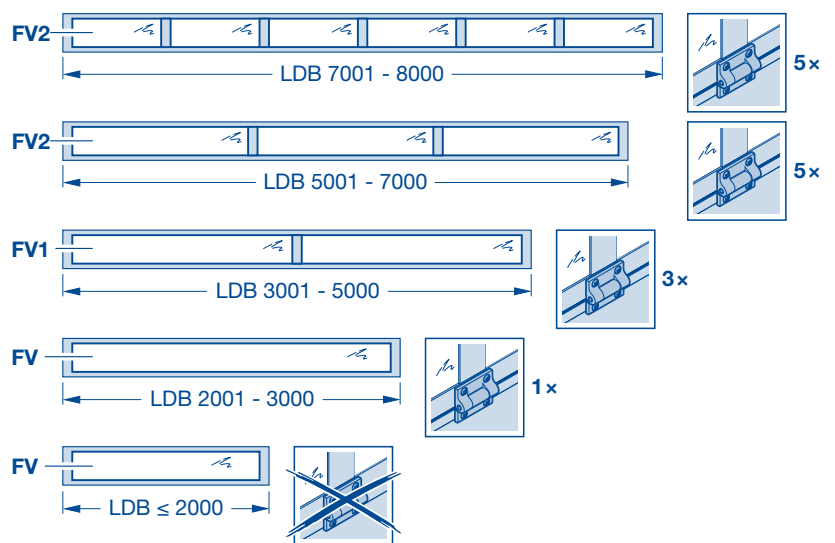
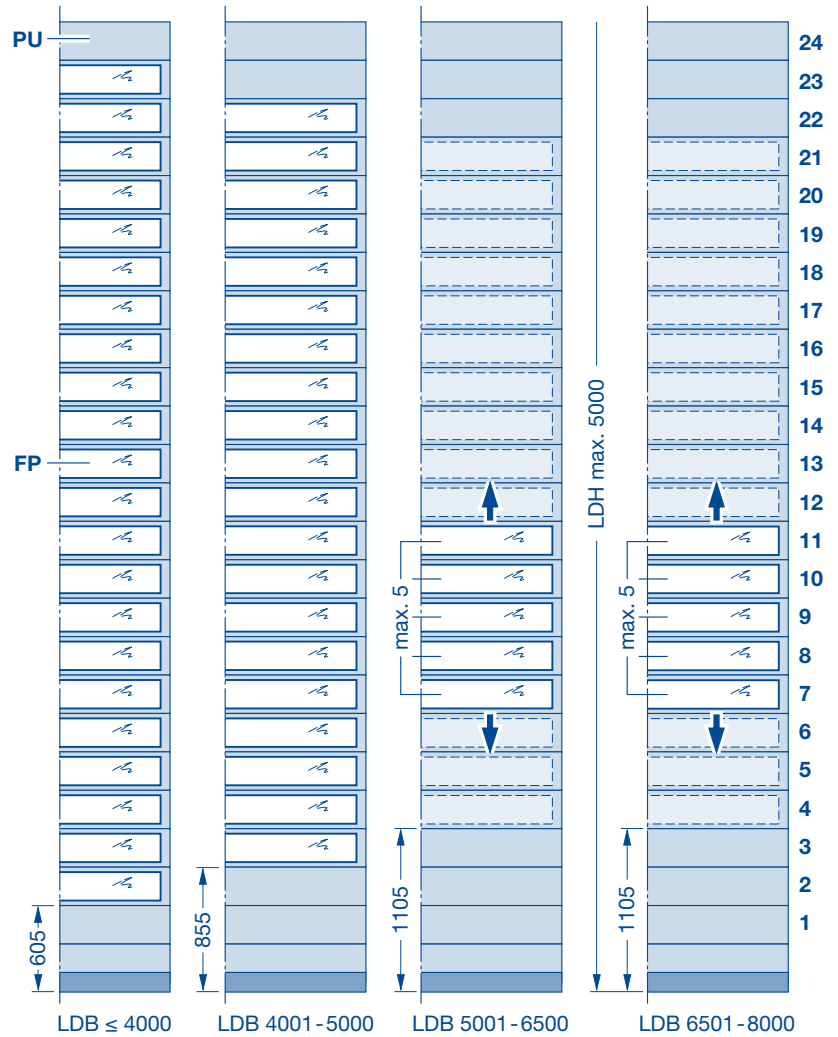
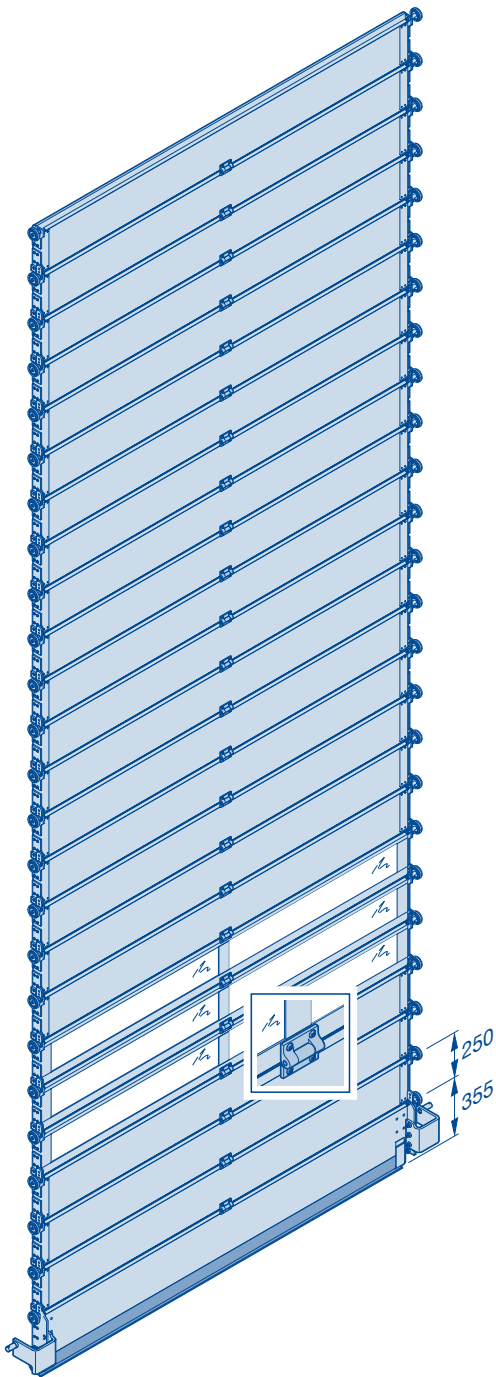

LDB Clear passage width
LDH Clear passage height
PU PU section 42 mm RAL9006

FP Window profile, E6 / C0 DURATEC synthetic glazing 26 mm
FV Window profile without connecting rib
FV1 Window profile with 1 connecting rib

FV2 Window profile with 2 connecting ribs

Spiral doors and high-speed sectional doors HS 5015

Acoustic H

With aluminium sections

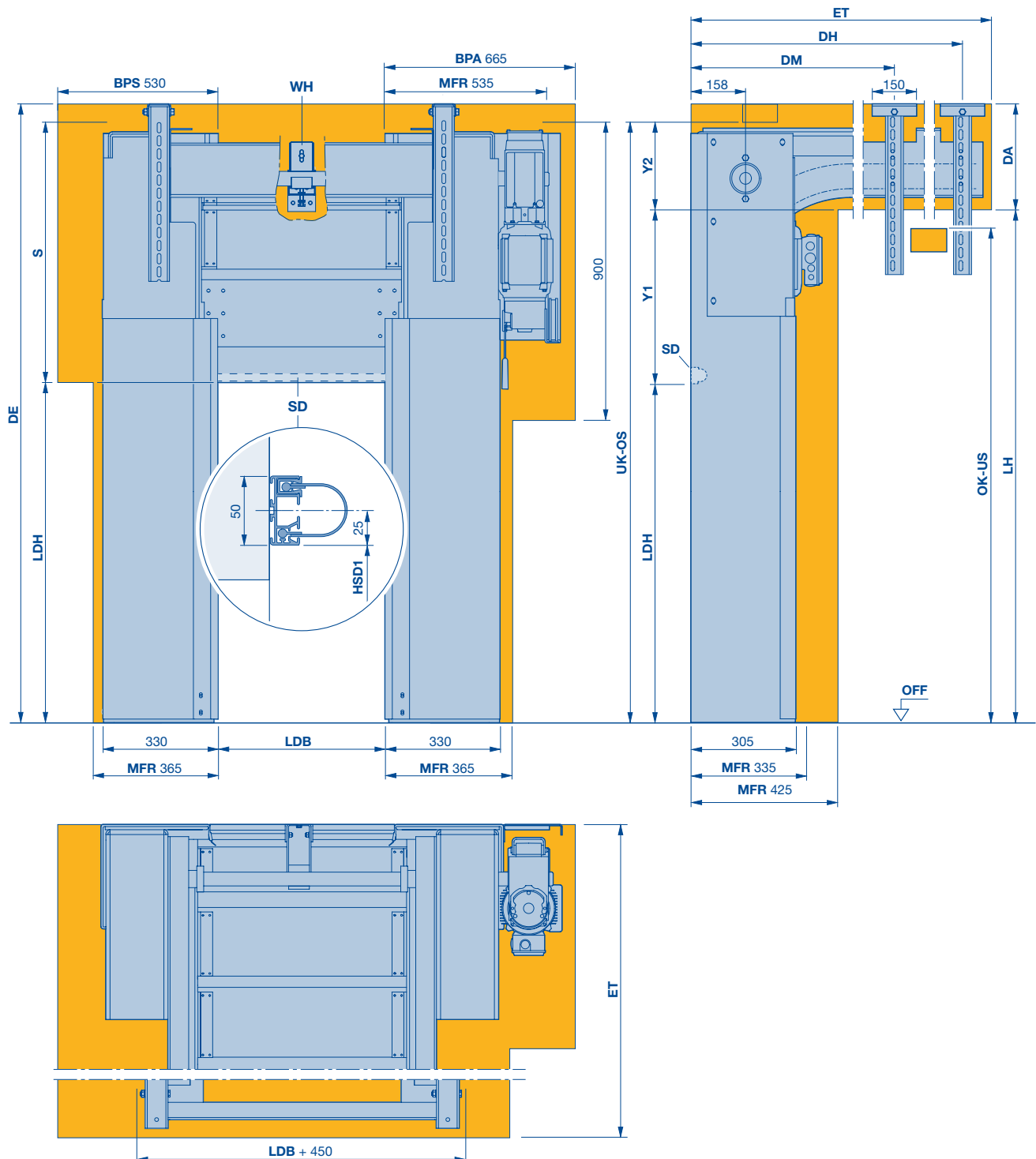

BPA Space required to fit and dismantle the operator
BPS Space required to fit and dismantle the side cover
DA Distance to ceiling $DE - LDH - S + Y2$
DE Ceiling height $DA + LDH + S - Y2$
DH Rear ceiling anchor ET - 120
DM Centre ceiling anchor 960 (ET > 1250)
ET Minimum distance back
 $2 \times LDH - (LDH + S) + 1000$ (min. 1250)

HSD1 Height of the lintel seal (dimension on request)
LDB Clear passage width
LDH Clear passage height
LH Track height $LDH + S - Y2$ (min. $LDH + Y1$)
MFR Space for fitting the door
OK Top edge
OS Top interference contour

S Required headroom at least 1000
SD Lintel seal
UK Bottom edge
US Bottom interference contour
WH Shaft support
Y1 $LDH < 2500 = 440$, $LDH > 2500 = 495$
Y2 $LDH < 2500 = 310$, $LDH > 2500 = 255$

Spiral doors and high-speed sectional doors HS 7030

Acoustic

With aluminium sections

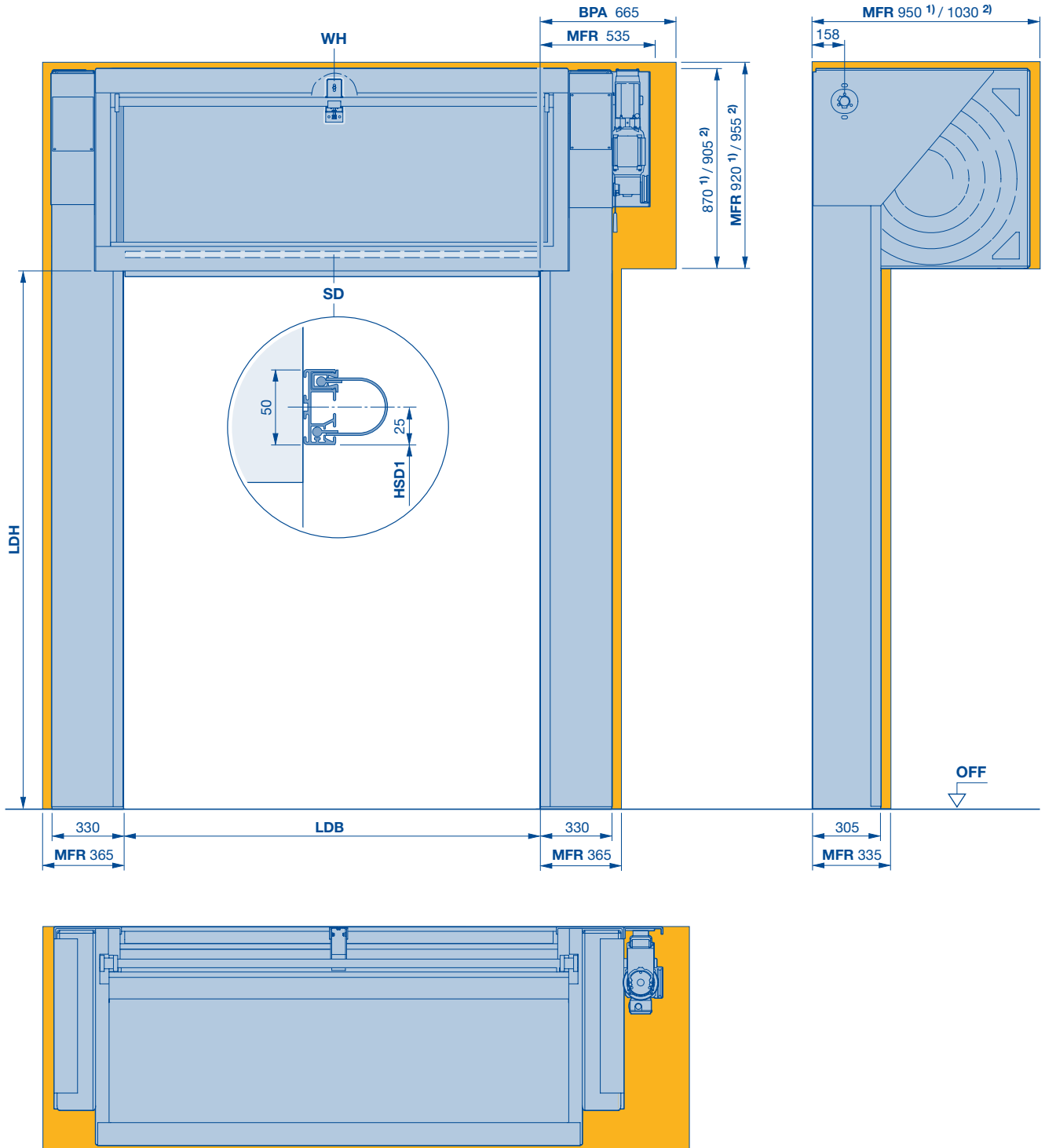

- | | |
|---|---|
| 1) LDH ≤ 4500 | LDB Clear passage width |
| 2) LDH > 4500 – ≤ 5000 | LDH Clear passage height |
| B Up to 5000 mm | MFR Space for fitting the door |
| BPA Space required to fit and dismantle the operator | SD Lintel seal |
| HSD1 Height of the lintel seal (dimension on request) | WH Shaft support
LDB > 3500 mm (1 ×) |

Spiral doors and high-speed sectional doors HS 7030

Acoustic

With aluminium sections

Full cladding, straight

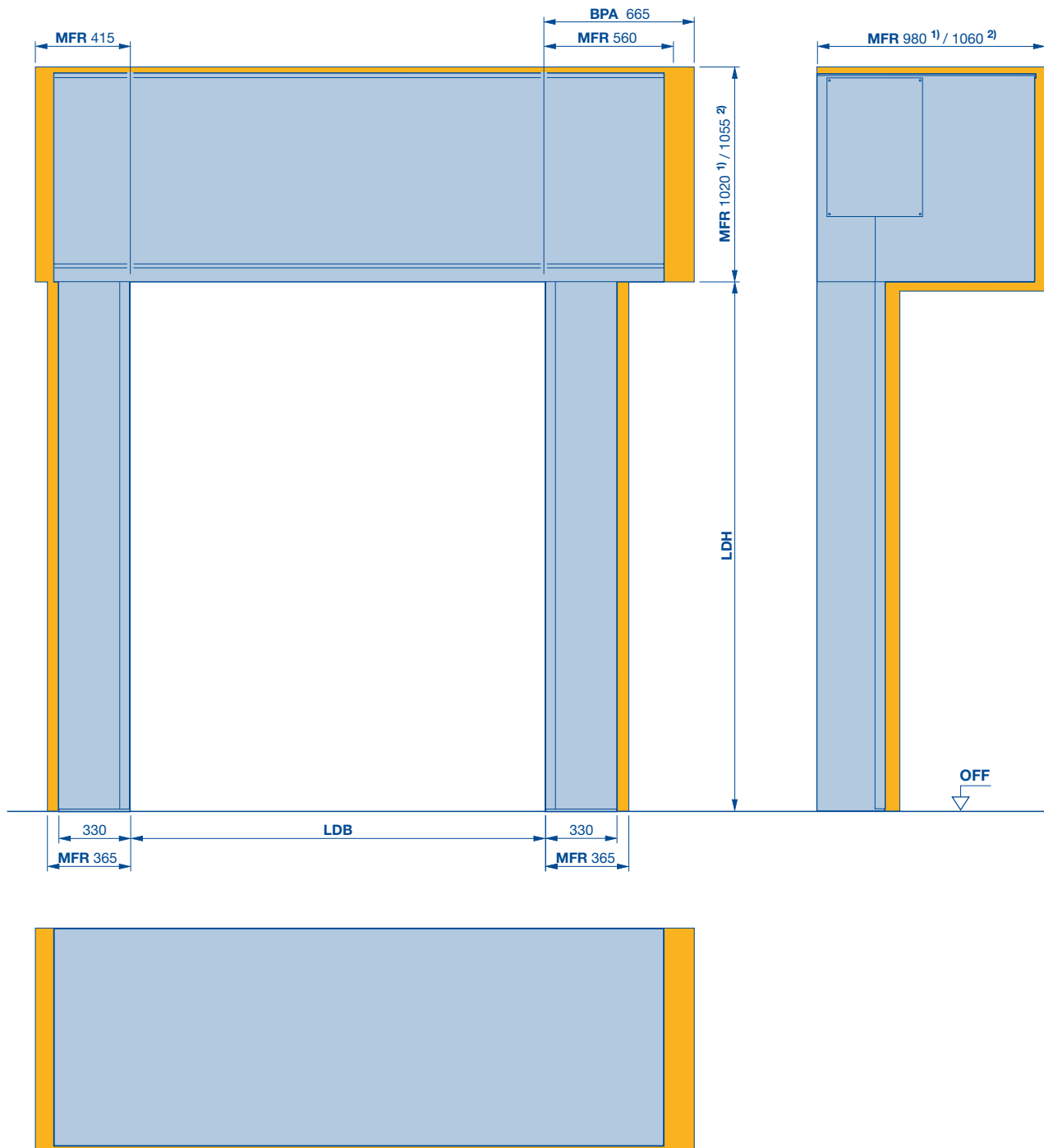

- 1) LDH ≤ 4500
 2) LDH > 4500 – ≤ 5000
BPA Space required to fit and dismantle the operator
HSD1 Height of the lintel seal (dimension on request)
LDB Clear passage width

- LDH** Clear passage height
MFR Space for fitting the door
SD Lintel seal
WH Shaft support
 LDB > 3500 mm (1 ×)

Spiral doors and high-speed sectional doors HS 7030

Acoustic

With aluminium sections

Full cladding, chamfered

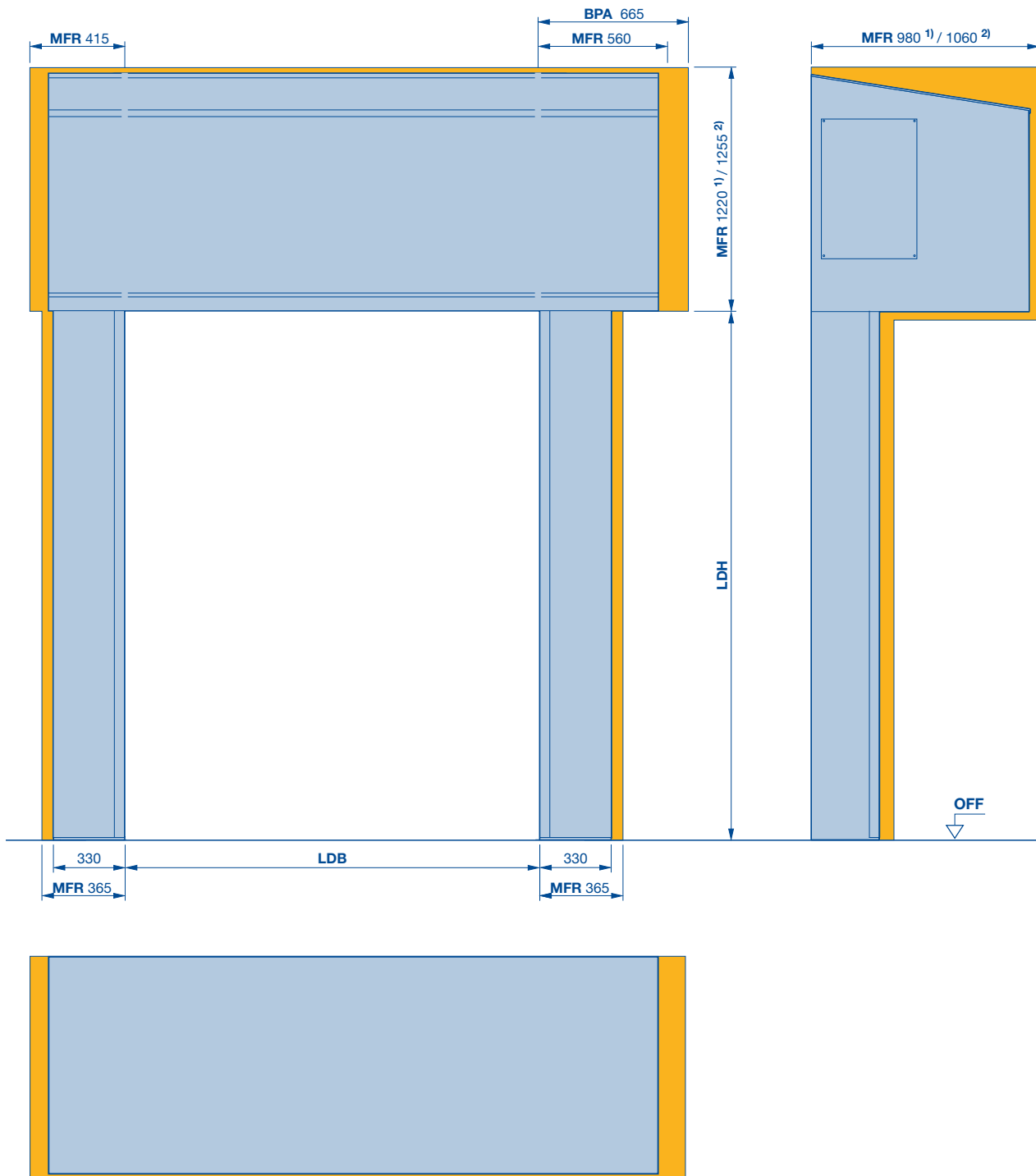

- 1) LDH ≤ 4500
 2) LDH > 4500 – ≤ 5000
 BPA Space required to fit and dismantle the operator
 HSD1 Height of the lintel seal (dimension on request)
 LDB Clear passage width

- LDH Clear passage height
 MFR Space for fitting the door
 SD Lintel seal
 WH Shaft support
 LDB > 3500 mm (1 x)

Spiral doors and high-speed sectional doors

HS 6015 Acoustic

With aluminium sections

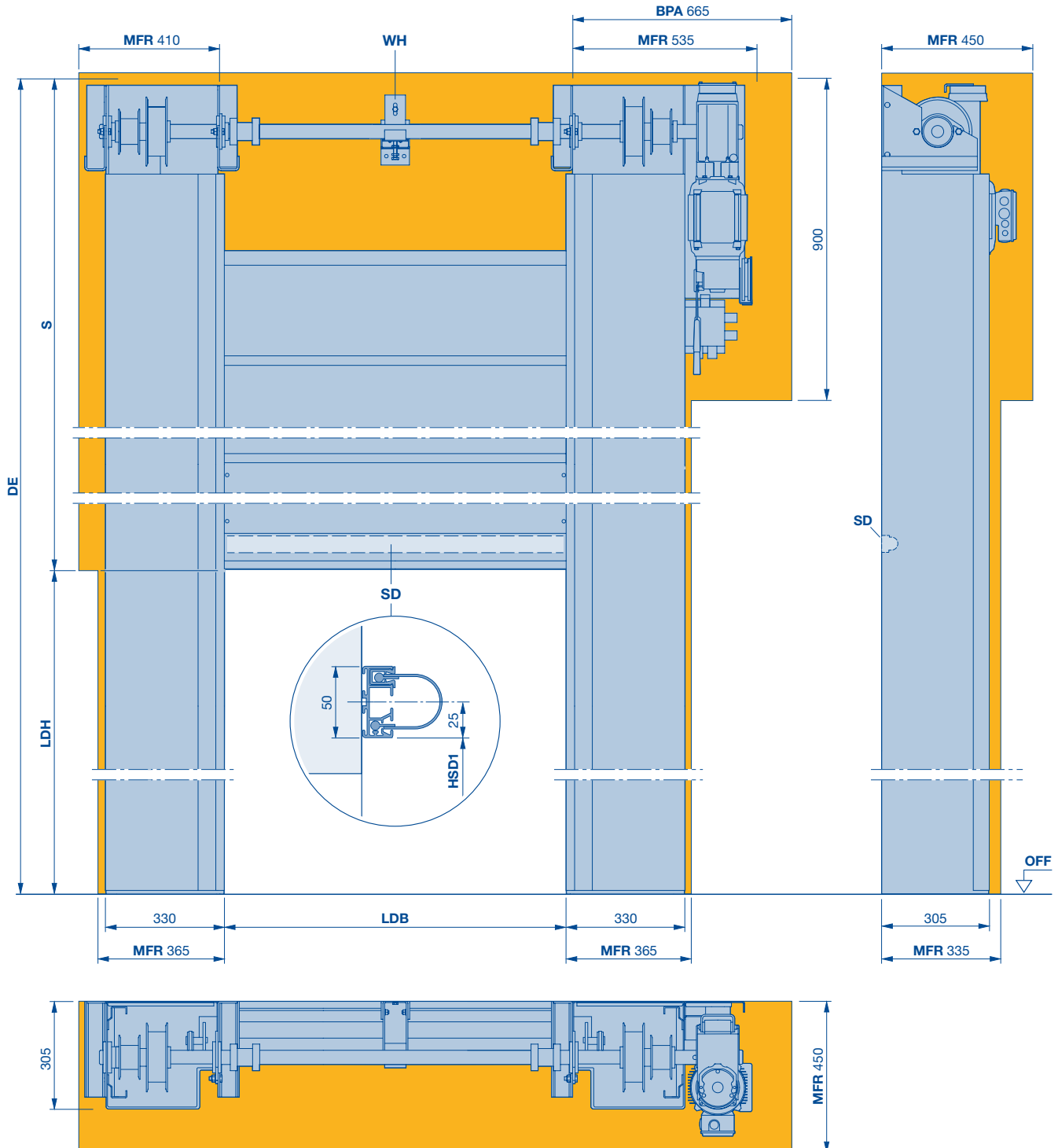

BPA Space required to fit and dismantle the operator

DE Ceiling height $2 \times LDH + 585$

HSD1 Height of the lintel seal (dimension on request)

LDH Clear passage height

LDB Clear passage width
LDB > 3500 (1 x)

MFR Space for fitting the door

S Required headroom at least $LDH + 585$

SD Lintel seal

WH Shaft support

Spiral doors and high-speed sectional doors

Iso Speed Cold H 100

With PU insulating panels and track application H (cold-storage door and deep freeze door)

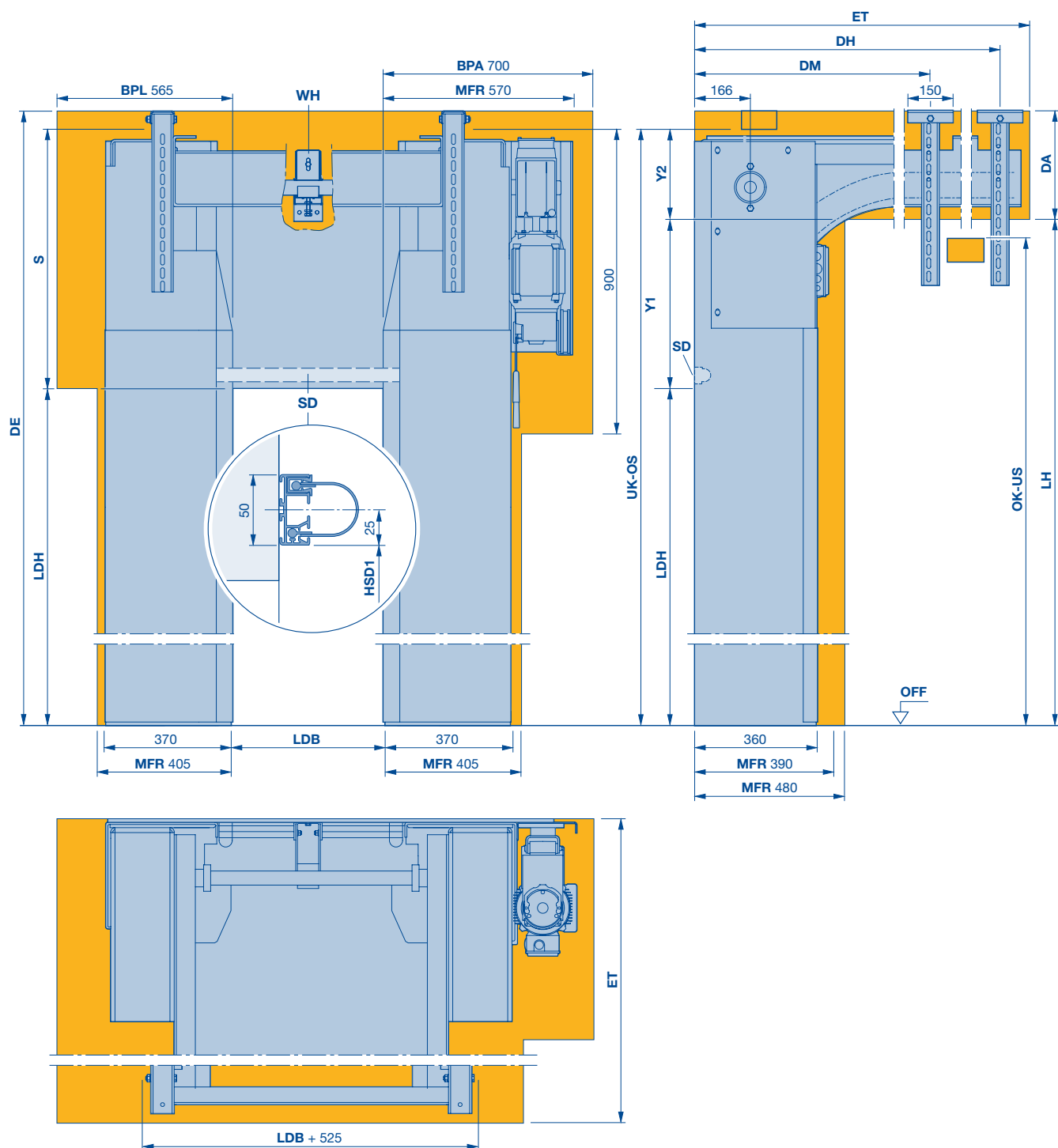

BPA Space required to fit and dismantle the operator

BPL Space required to fit and dismantle the support bearing

DA Distance to ceiling $DE - LDH - S + Y2$

DE Ceiling height $DA + LDH + S - Y2$

DH Rear ceiling anchor $ET - 120$

DM Centre ceiling anchor 1015 ($ET > 1250$)

ET Minimum distance back
 $2 \times LDH - (LDH + S) + 1060$, min. 1250

HSD1 Height of the lintel seal (dimension on request)

LDB Clear passage width

LDH Clear passage height

LH Track height $LDH + S - Y2$
(At least $LDH + Y1$)

MFR Space for fitting the door

OK Top edge

OS Top interference contour

S Required headroom at least 750, maximum $LDH + 585$

SD Lintel seal

UK Bottom edge

US Bottom interference contour

WH Shaft support

Y1 $LDH + S - 400 < 2500 = 440$
 $LDH + S - 400 \geq 2500 = 495$

Y2 $LDH + S - 400 < 2500 = 310$
 $LDH + S - 400 \geq 2500 = 255$

Spiral doors and high-speed sectional doors

Iso Speed Cold V 100

With PU insulating panels and track application V (cold-storage door and deep freeze door)

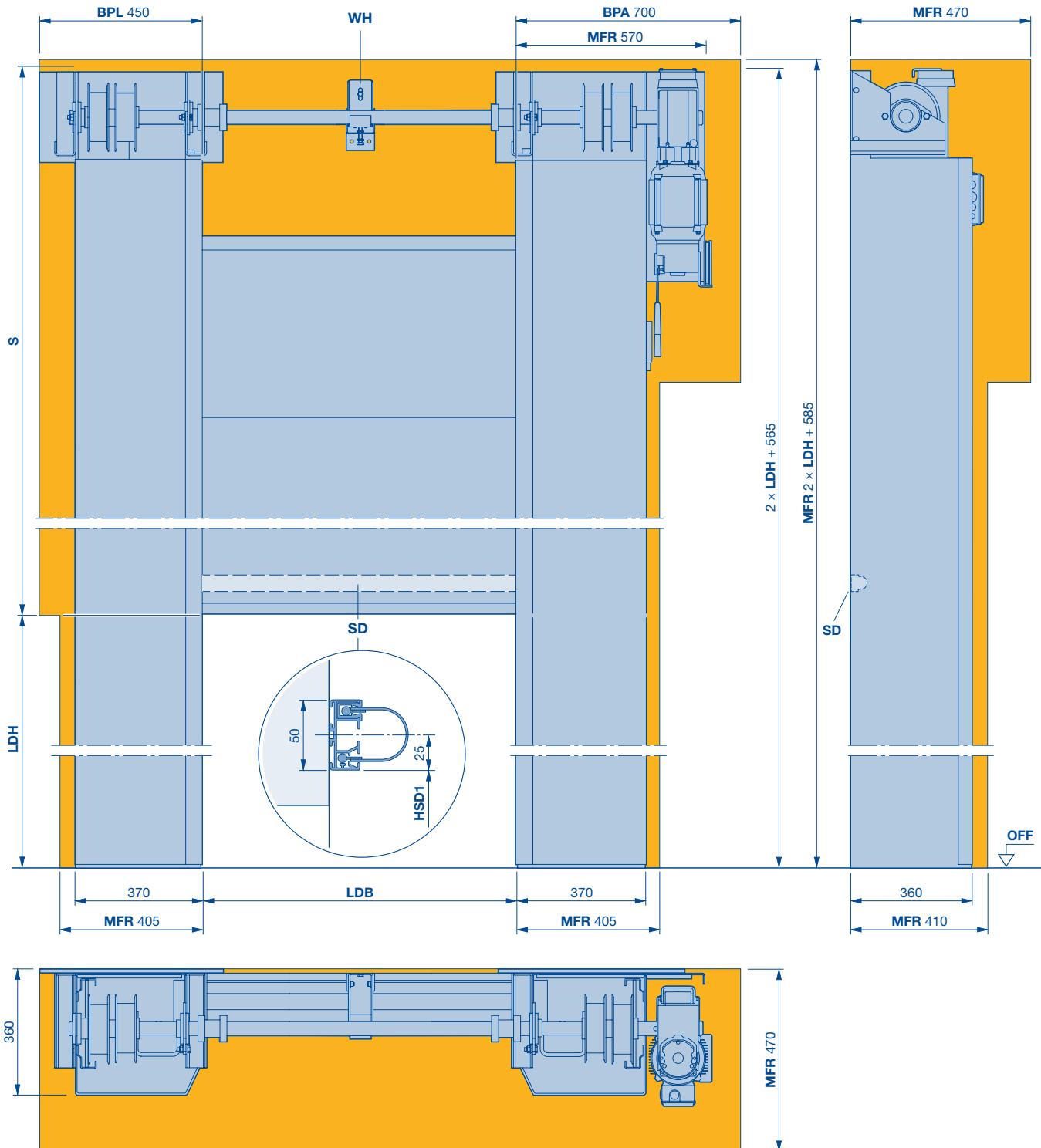

BPA Space required to fit and dismantle the operator
BPL Space required to fit and dismantle the support bearing
DE Ceiling height $2 \times LDH + 585$
HSD1 Height of the lintel seal (dimension on request)

LDB Clear passage width
LDH Clear passage height
MFR Space for fitting the door
S Required headroom at least $LDH + 585$
SD Lintel seal
WH Shaft support

High-speed doors with flexible door leaf

Technical data for internal doors

Use	Internal door	
	External door	
Door sizes	Maximum width LDB	
	Maximum height LDH	
Speed	FU control, 3-phase	Max. opening approx. m/s
	FU control, 1-phase	Max. opening approx. m/s
		Max. closing approx. m/s
Security features	EN 13241	
Wind load resistance	EN 12424	
Door construction	Self-supporting	
Material	Galvanized steel	
	Aluminium	
	Polished stainless steel V2 A	
Operator cover and shaft cover	Straight	
	30 chamfered	
Door leaf	Fabric, transparent	1.5/2.0 mm
	Aluminium or spring steel wind lock, curtain slide	
	Door leaf tension	
SoftEdge or aluminium bottom profile		
Operator and control	Frequency converter	
	Connecting voltage	1-phase, 1–230 V, N, PE
		3-phase, 3–400 V, N, PE
	Open-Stop-Close button	
	Main switch, all-pole switch-off	1-phase
		3-phase
	Emergency-off button	1-phase
		3-phase
	Fuse protection	1-phase, 3-phase
	Protection category for control	
	Protection category for operator	
	Closing zone monitoring	Safety light grille IP 67
	Hold-open phase, in sec.	
	Electronic limit switch DES	
	Electronic limit switch Multiturn	
Emergency opening	Emergency crank handle	
	Emergency hand chain	
	Emergency opening with ½ inch operator	
	UPS in a plastic cabinet	
Volt-free contacts		
Plug-in control wiring		

● = Standard

○ = Optional

V 4020 SEL Alu-R	V 4008 SEL	V 5015 SEL	V 5030 SEL
●	●	●	●
—	—	—	—
4500	4000	5000	5000
4500	4000	5000	5000
—	—	—	2,0
2,0	0,8	1,5	2,0
0,8	0,8	0,8	0,8
●	●	●	●
npd, class 3 with aluminium bottom part	npd	npd	npd, class 1 with aluminium bottom part
●	●	●	●
●1)	●	●	●
●	—	—	—
—	—	○	○
●	○	○	○
—	—	○	○
●	●	●	●
-/●/-	-/-/●	●/-/-	-/●/-
—	—	—	—
●/○	●/-	●/-	●/○
●	—	●	●
●	—	●	●
—	●	—	○
●	●	●	●
○	—	○	○
—	●	—	●
○	—	○	○
—	●	—	●
16 A, slow-acting	10 A, slow-acting	16 A, slow-acting	16 A, slow-acting
IP 65	IP 65	IP 65	IP 65
IP 54	IP 54	IP 54	IP 54
●	●	●	●
1-200	1-200	1-200	1-200
—	●	●	●
●	—	—	—
—	●	●	●
—	—	○	○
●	—	—	—
○	—	○	○
3	2	3	3
●	—	●	●

1) Barrel cover, painted in RAL 9006

High-speed doors with flexible door leaf

V 4020 SEL Alu-R

With tubular drive and external control panel,
SoftEdge / aluminium bottom part

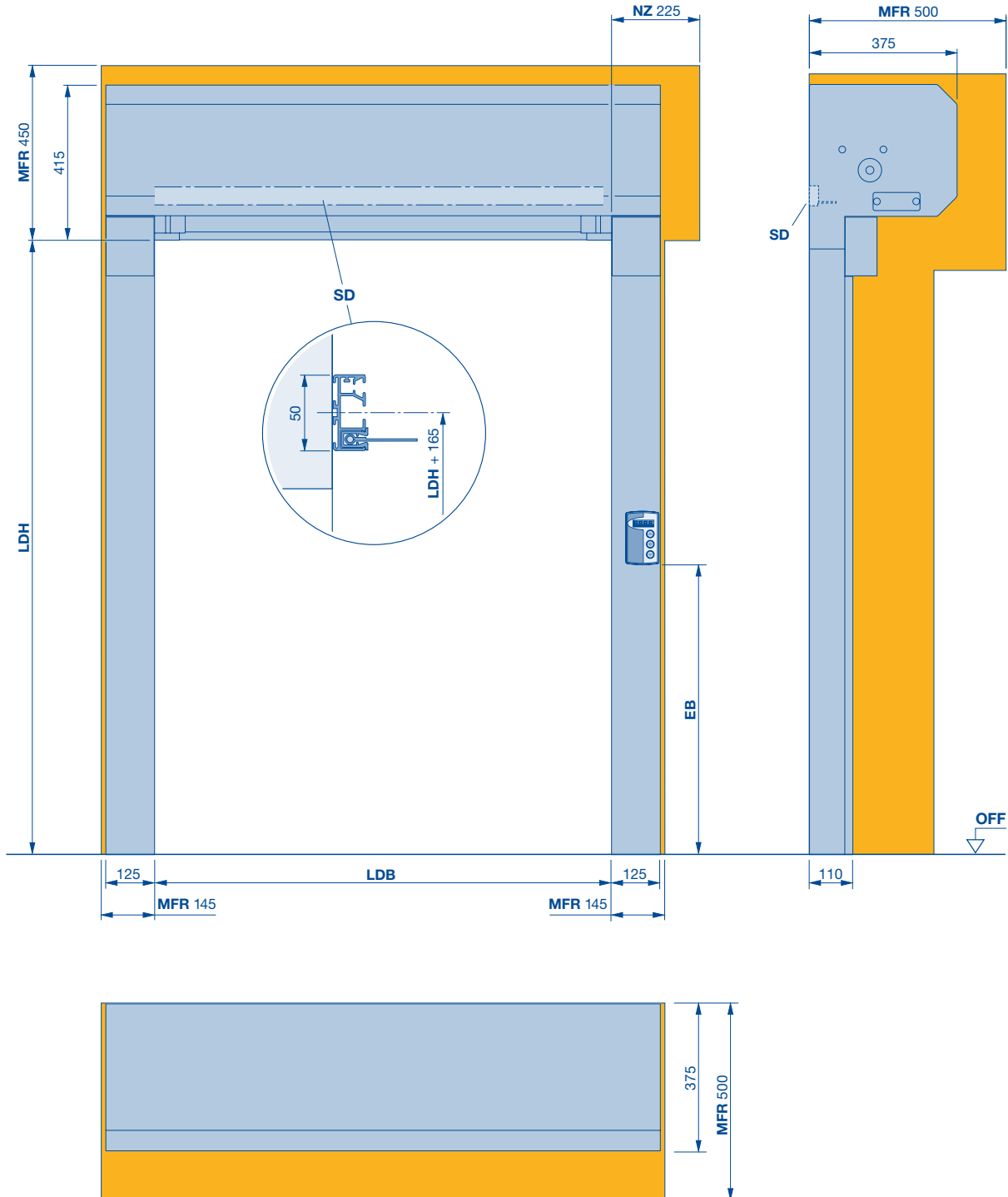

BPA Space required to fit and dismantle the operator
LSW External control unit
LDB Clear passage width

LDH Clear passage height
SD Lintel seal
MFR Space for fitting the door side part
NZ Emergency opening with ½ inch operator

High-speed doors with flexible door leaf

V 4020 SEL Alu-R

With tubular drive, SoftEdge / aluminium bottom part

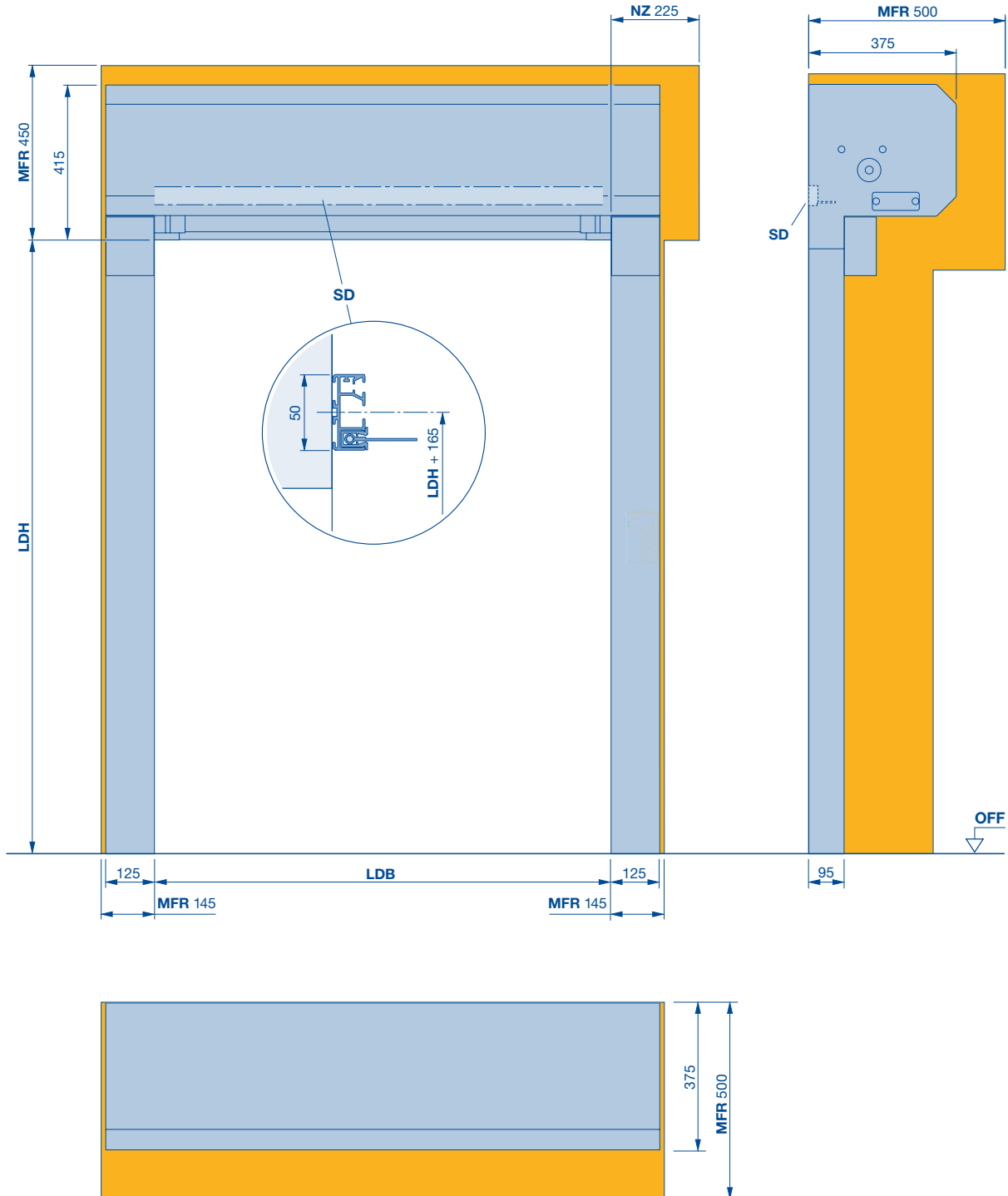

- BPA** Space required to fit and dismantle the operator
- LDB** Clear passage width
- LDH** Clear passage height

- SD** Lintel seal
- MFR** Space for fitting the door side part
- NZ** Emergency opening with ½ inch operator

High-speed doors with flexible door leaf V 4008 SEL

With SoftEdge and anti-crash

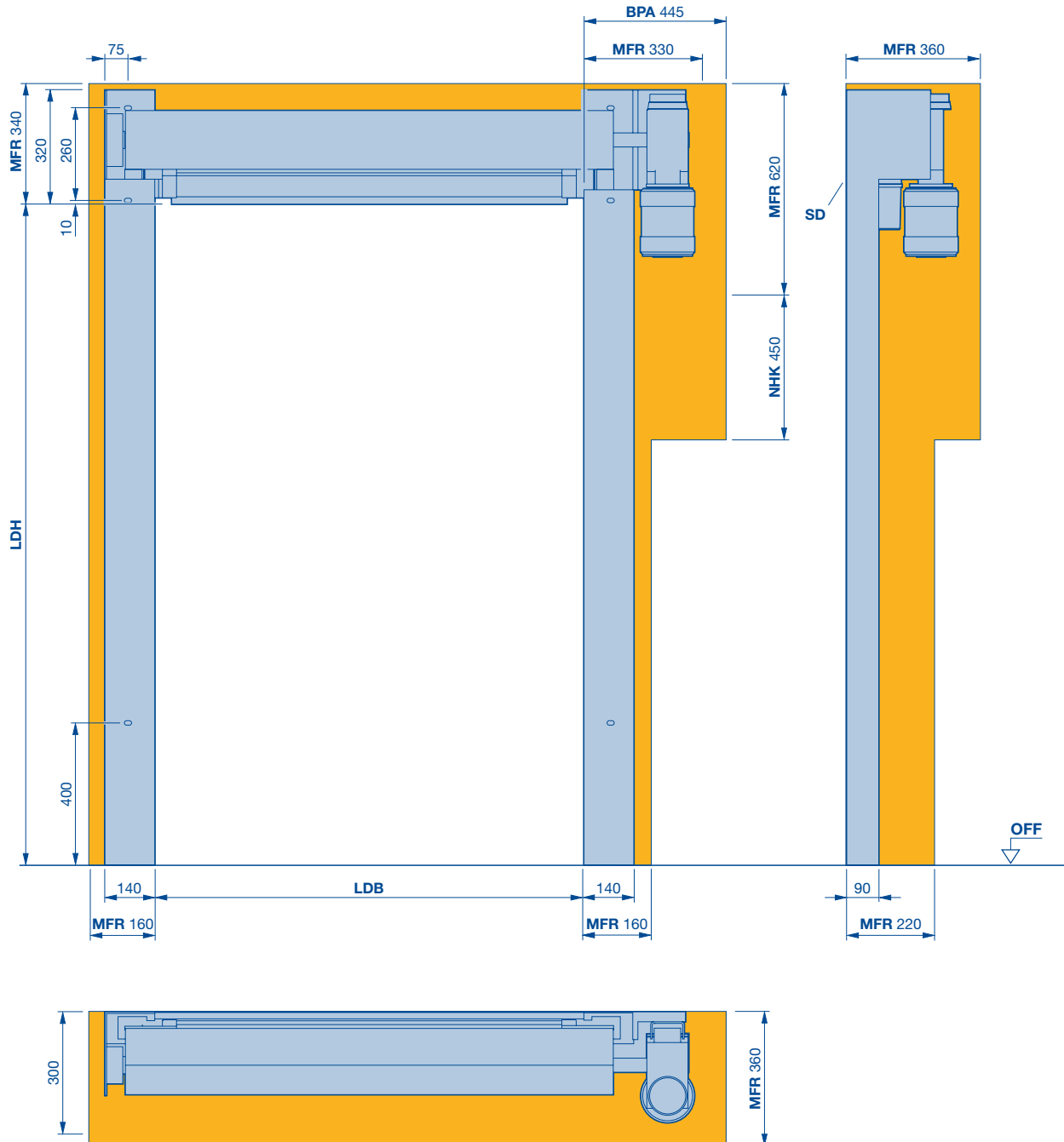

- BPA** Space required to fit and dismantle the operator
- LDB** Clear passage width
- LDH** Clear passage height

- NHK** Space requirement for emergency crank handle
- SD** Lintel seal
- MFR** Space for fitting the door side part

High-speed doors with flexible door leaf V 4008 SEL

With SoftEdge and anti-crash

Full cladding, straight

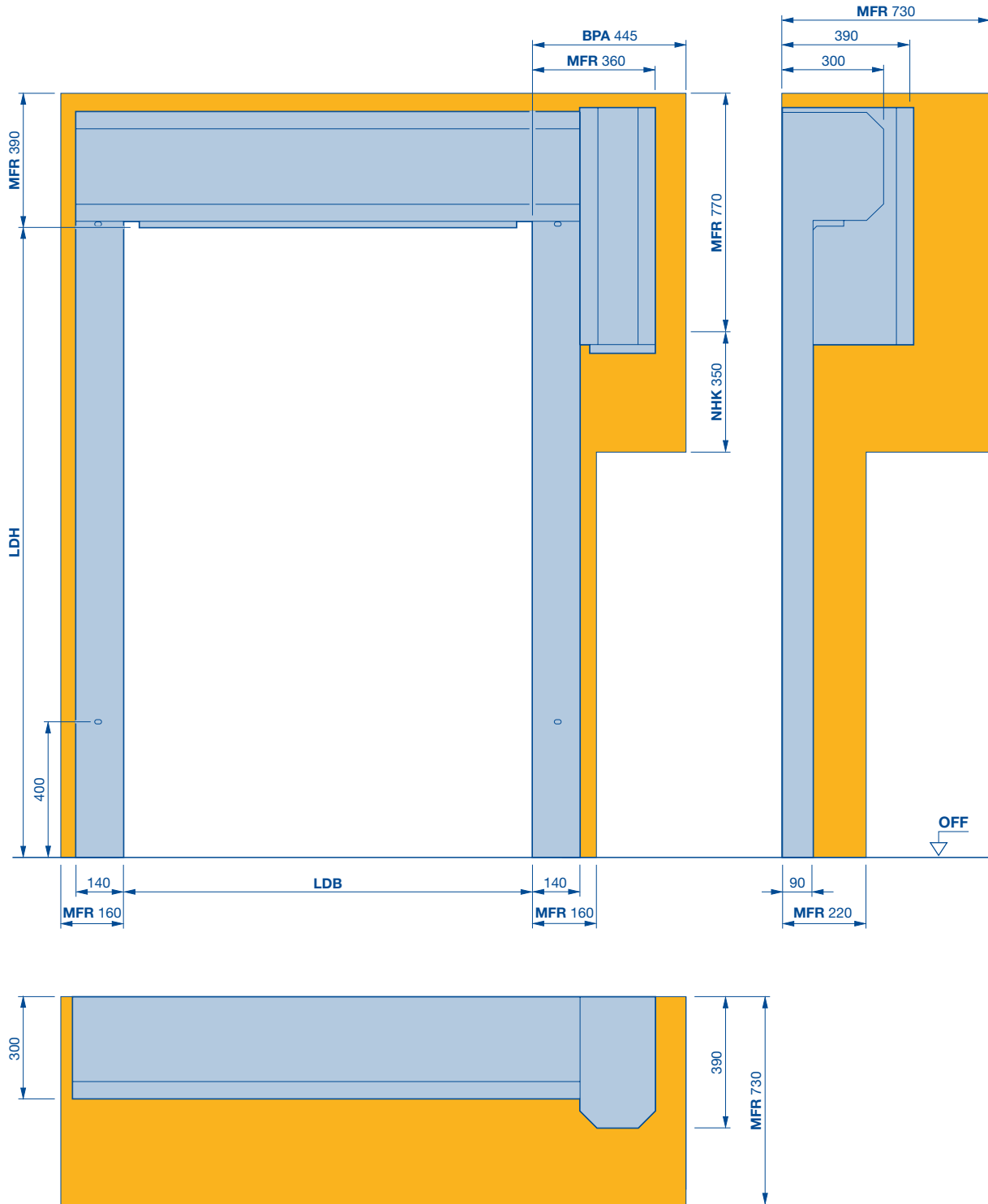

- BPA** Space required to fit and dismantle the operator
- LDB** Clear passage width
- LDH** Clear passage height

- NHK** Space requirement for emergency crank handle
- SD** Lintel seal
- MFR** Space for fitting the door side part

High-speed doors as internal doors V 5015 SEL

With SoftEdge and anti-crash

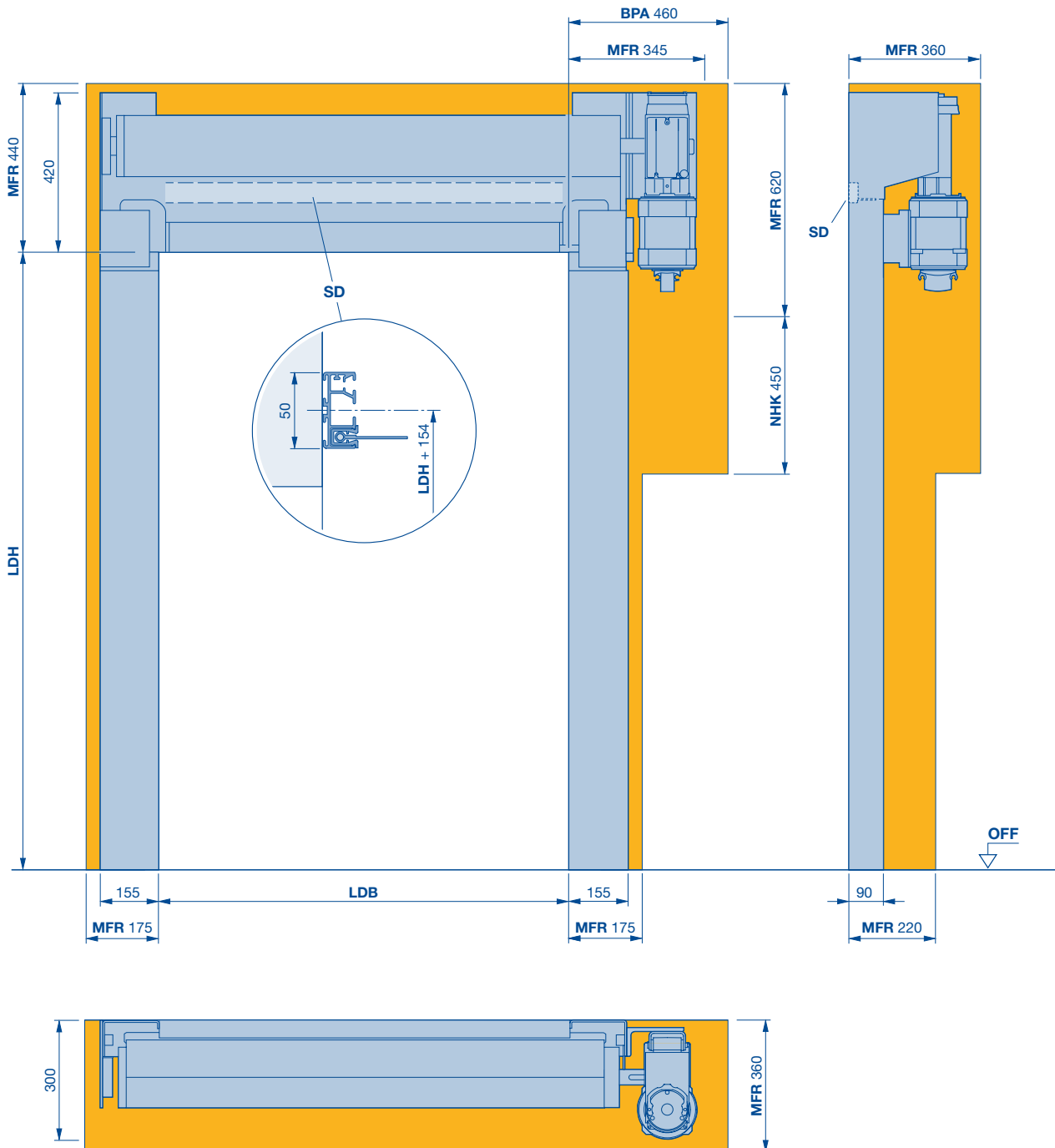

BPA Space required to fit and dismantle the operator
LDB Clear passage width
LDH Clear passage height

MFR Space for fitting the door
NHK Space requirement for emergency crank handle
SD Lintel seal

High-speed doors with flexible door leaf V 5015 SEL

With SoftEdge and anti-crash

Full cladding, straight

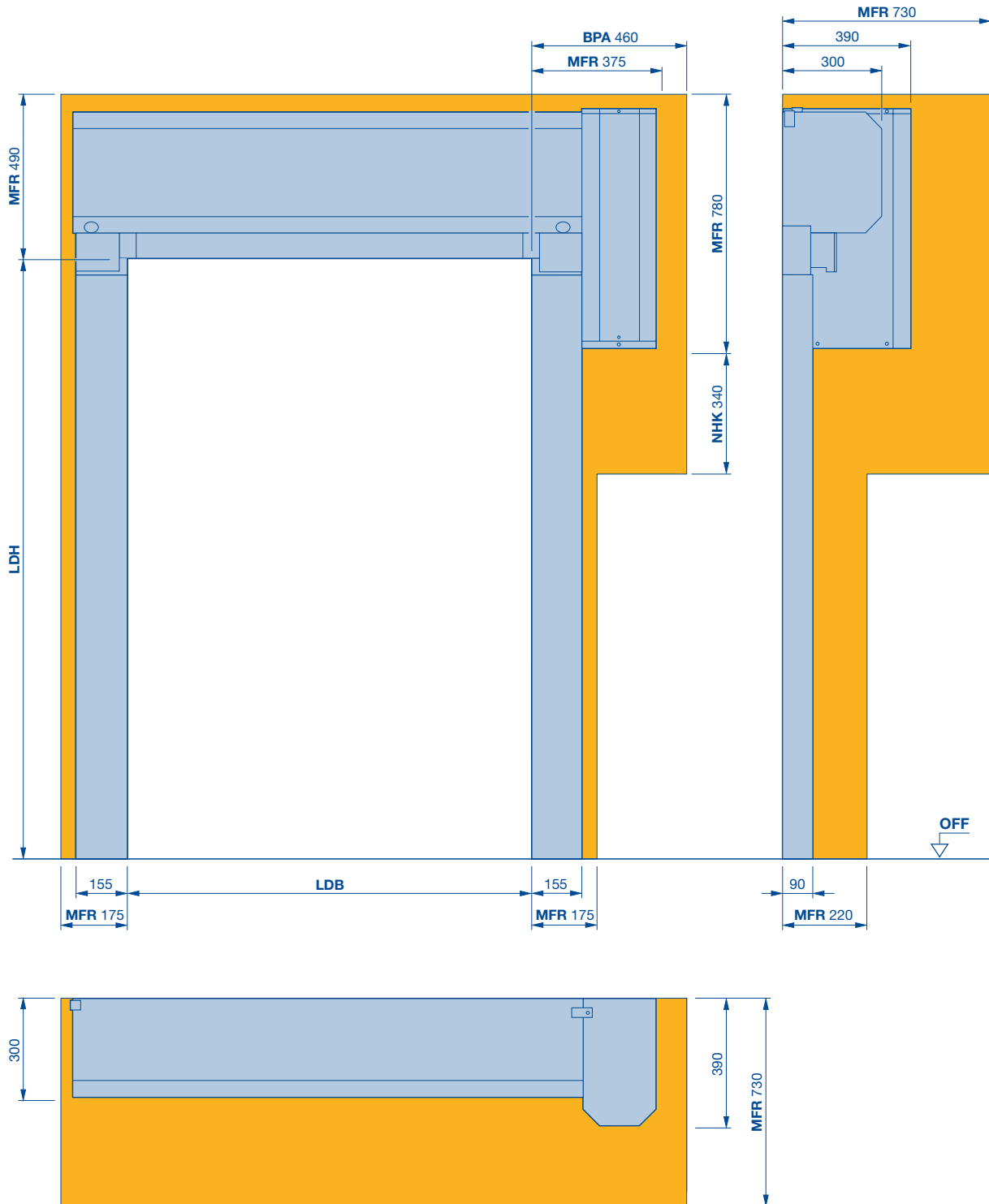

BPA Space required to fit and dismantle the operator
LDB Clear passage width
LDH Clear passage height

MFR Space for fitting the door
NHK Space requirement for emergency crank handle

High-speed doors with flexible door leaf V 5015 SEL

With SoftEdge and anti-crash

Full cladding, chamfered

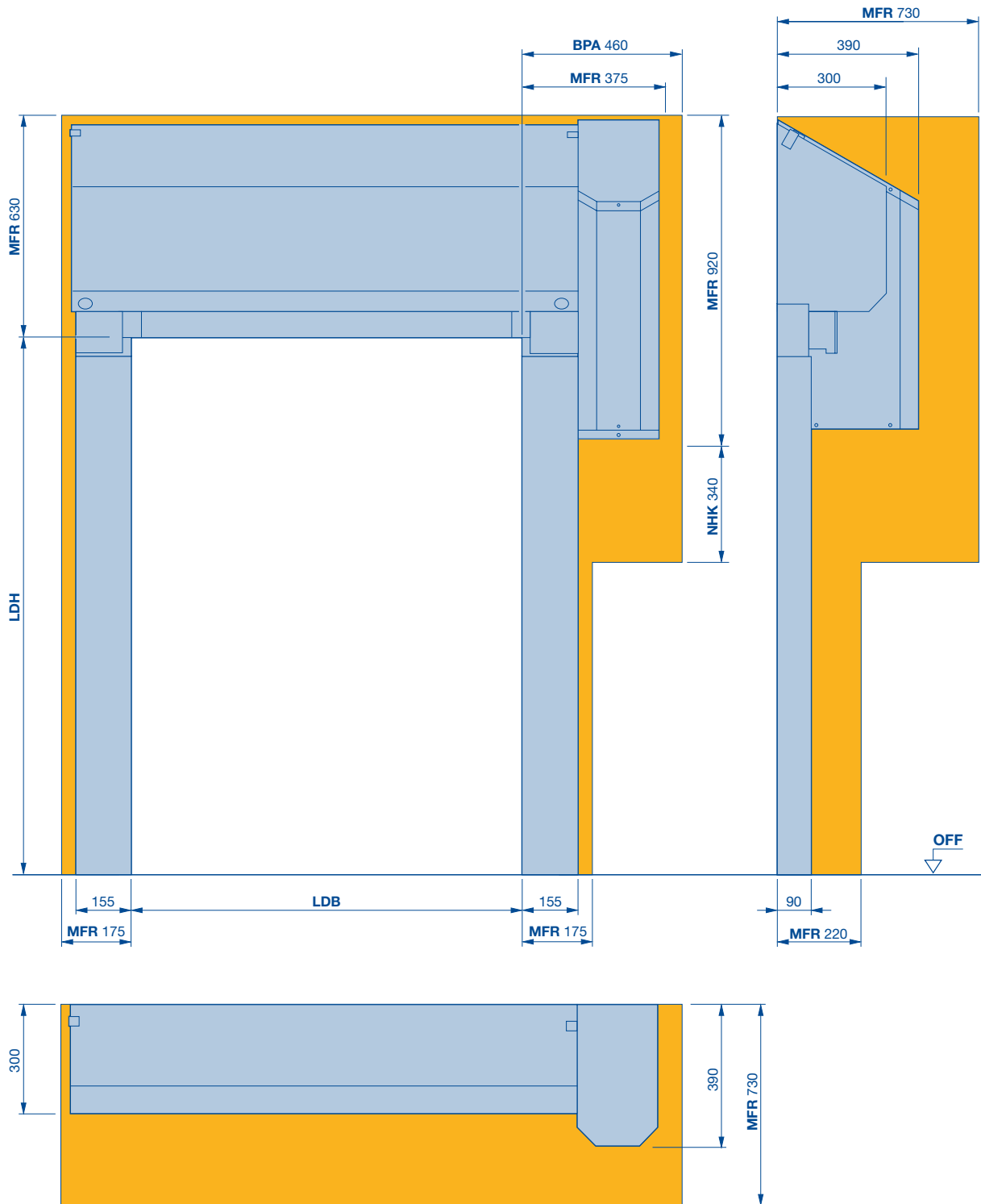

BPA Space required to fit and dismantle the operator
LDB Clear passage width
LDH Clear passage height

MFR Space for fitting the door
NHK Space requirement for emergency crank handle

High-speed doors with flexible door leaf V 5030 SEL

With SoftEdge and anti-crash

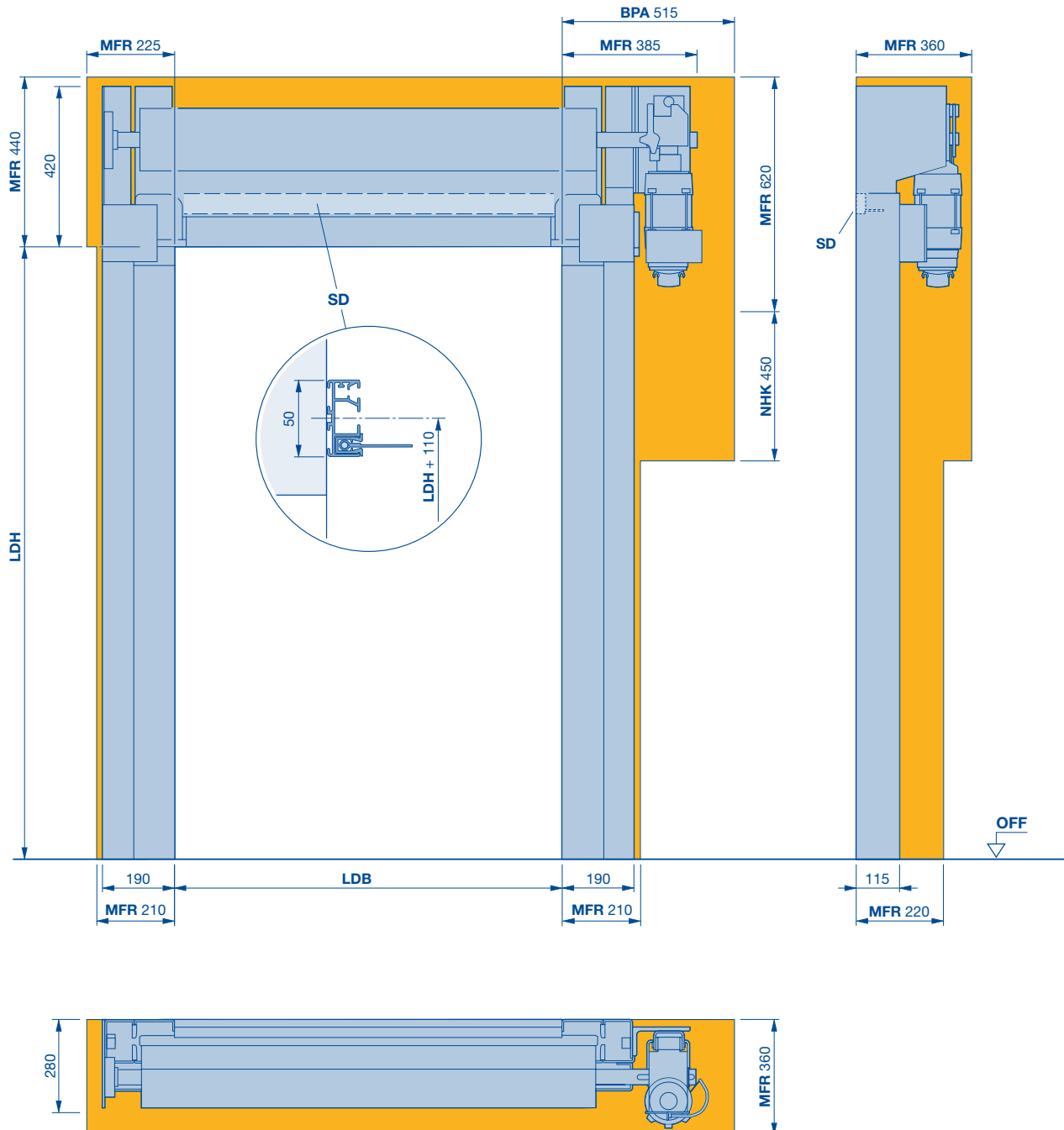

BPA Space required to fit and dismantle the operator
LDB Clear passage width
LDH Clear passage height

MFR Space for fitting the door
NHK Space requirement for emergency crank handle
SD Lintel seal

High-speed doors with flexible door leaf V 5030 SEL

With SoftEdge and anti-crash

Full cladding, straight

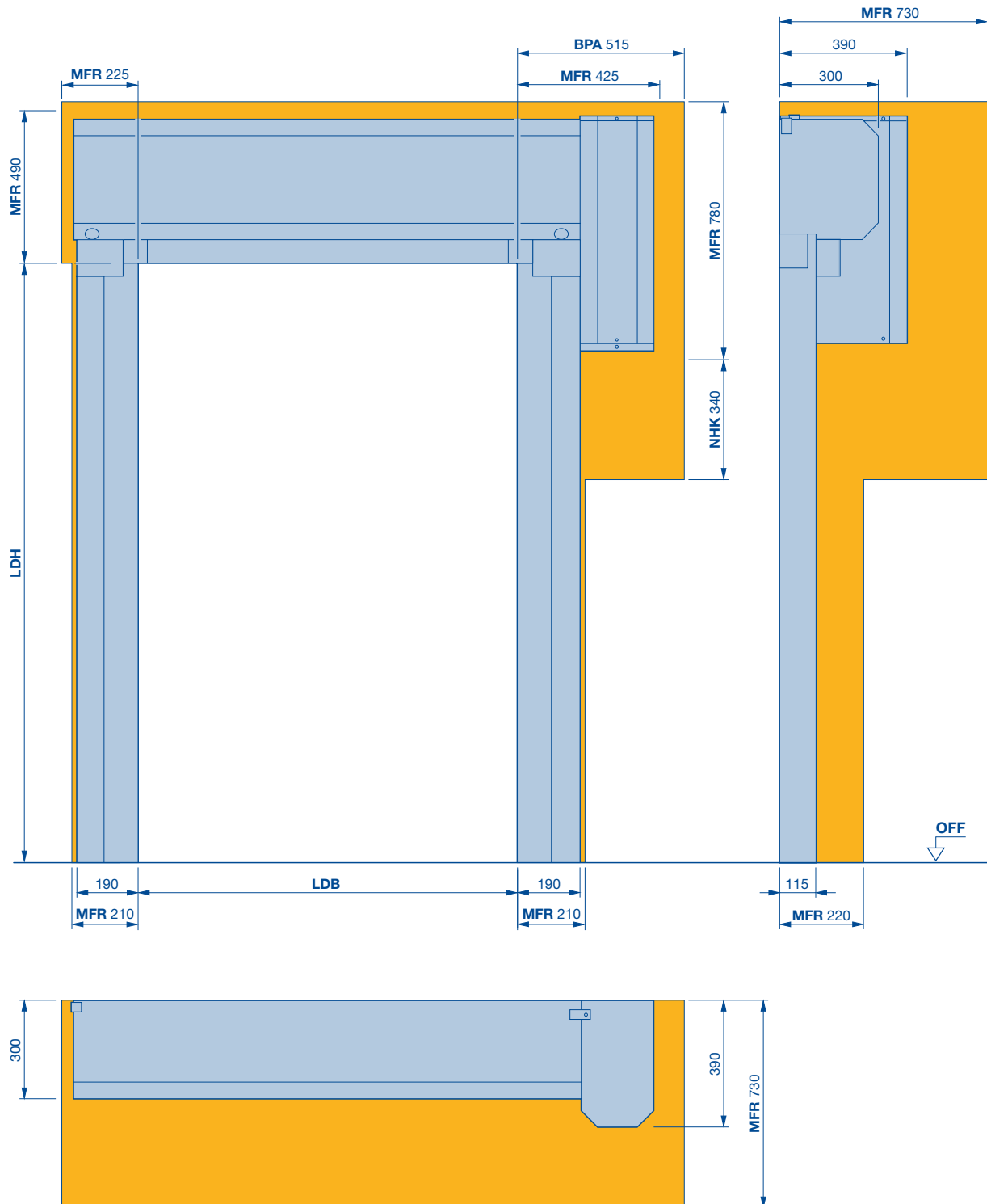

BPA Space required to fit and dismantle the operator

LDB Clear passage width

LDH Clear passage height

MFR Space for fitting the door

NHK Space requirement for emergency crank handle

High-speed doors with flexible door leaf V 5030 SEL

With SoftEdge and anti-crash

Full cladding, chamfered

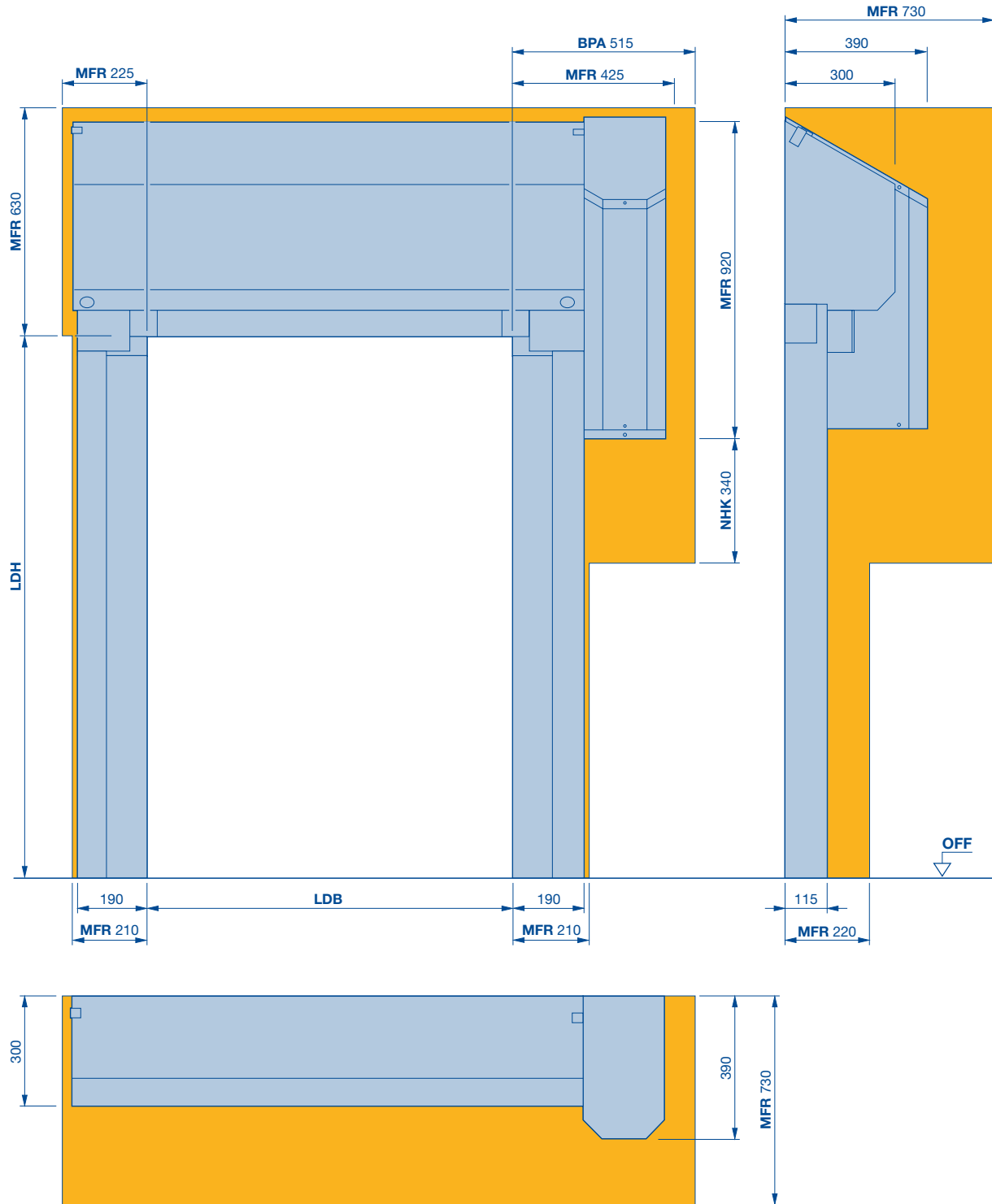

BPA Space required to fit and dismantle the operator
LDB Clear passage width
LDH Clear passage height

MFR Space for fitting the door
NHK Space requirement for emergency crank handle

High-speed doors with flexible door leaf V 5030 SEL

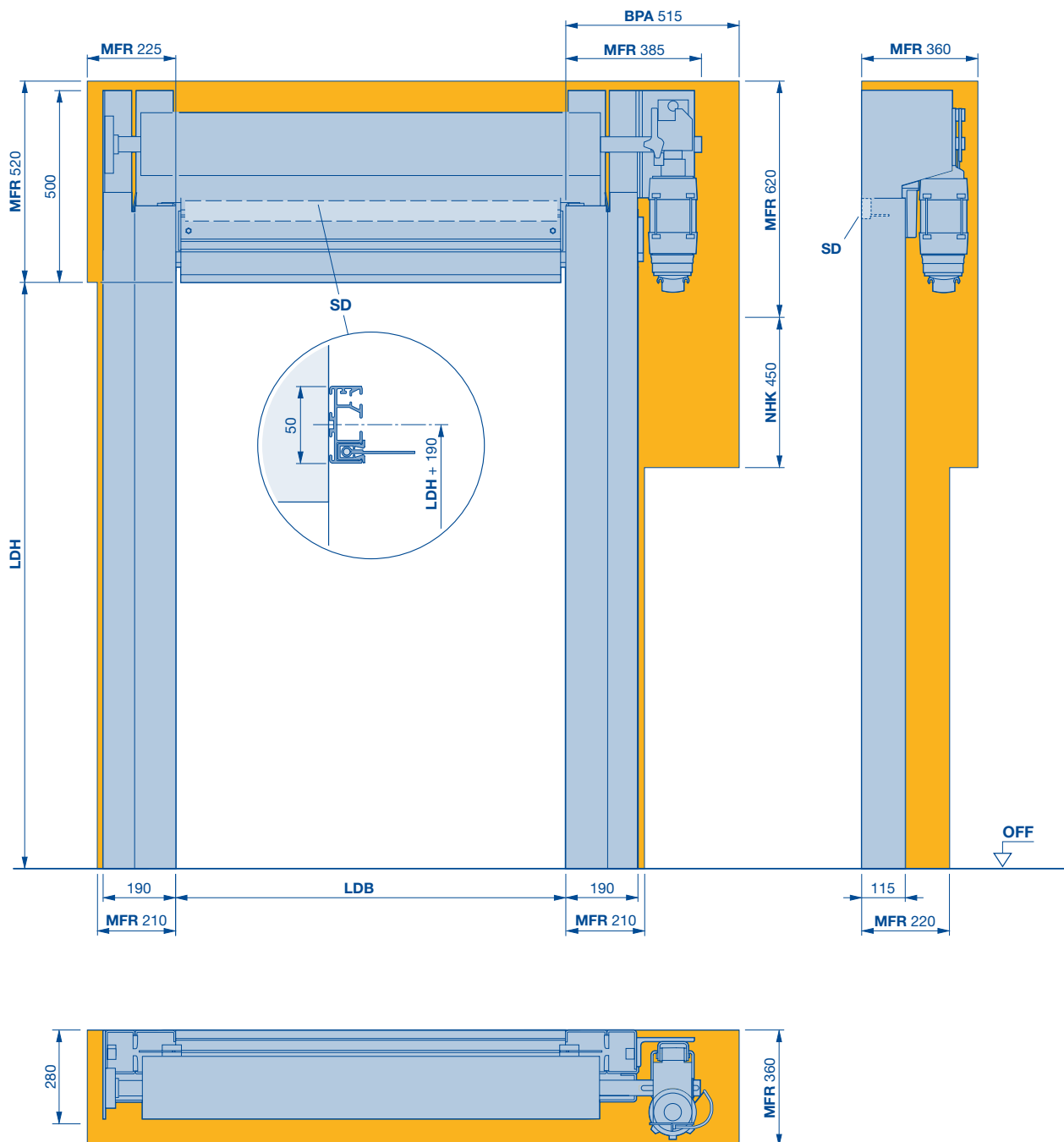

BPA Space required to fit and dismantle the operator
LDB Clear passage width
LDH Clear passage height

MFR Space for fitting the door
NHK Space requirement for emergency crank handle
SD Lintel seal

High-speed doors with flexible door leaf V 5030 SEL

Full cladding, straight

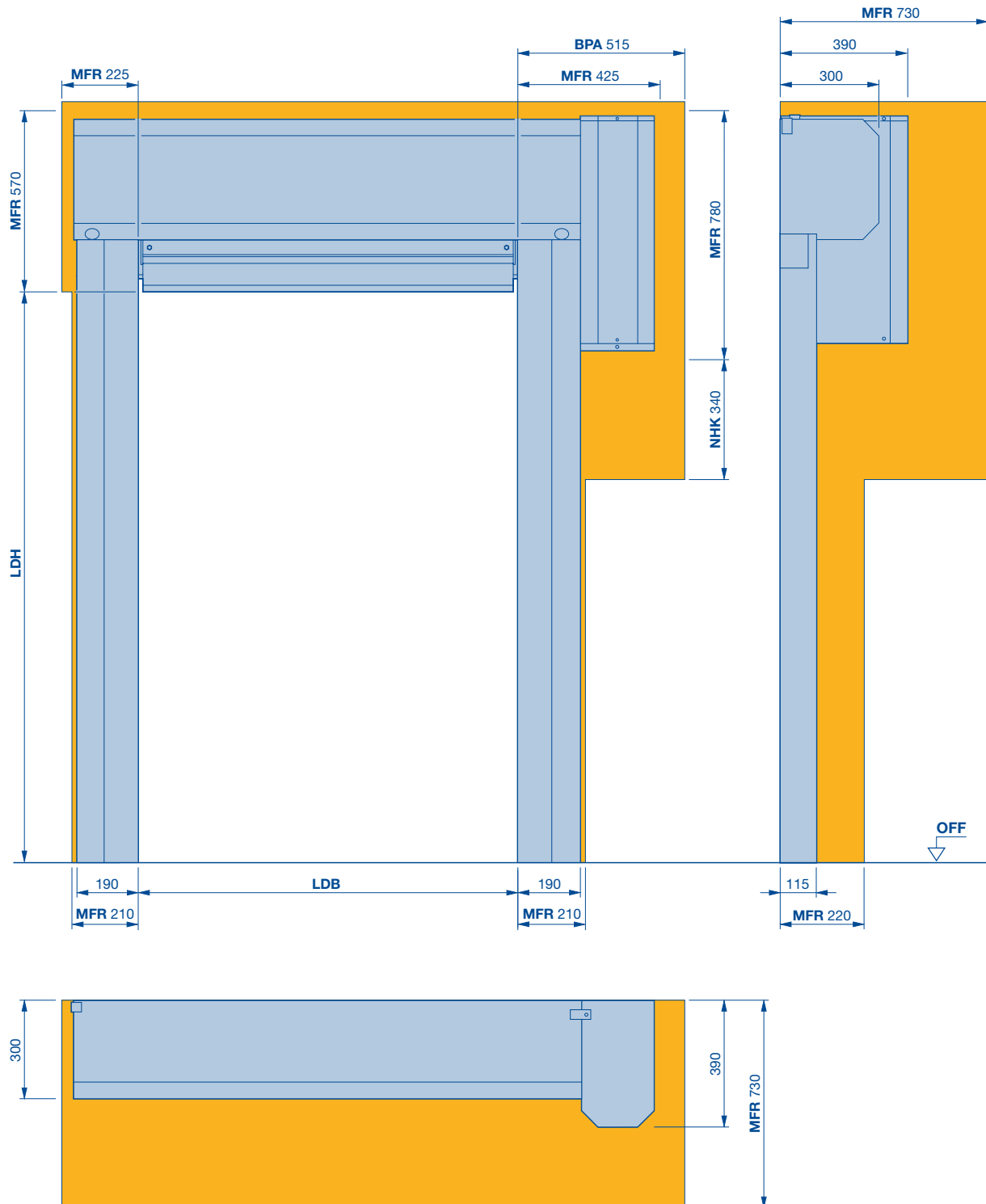

BPA Space required to fit and dismantle the operator
LDB Clear passage width
LDH Clear passage height

MFR Space for fitting the door
NHK Space requirement for emergency crank handle

High-speed doors with flexible door leaf V 5030 SEL

With aluminium bottom part and anti-crash

Full cladding, chamfered

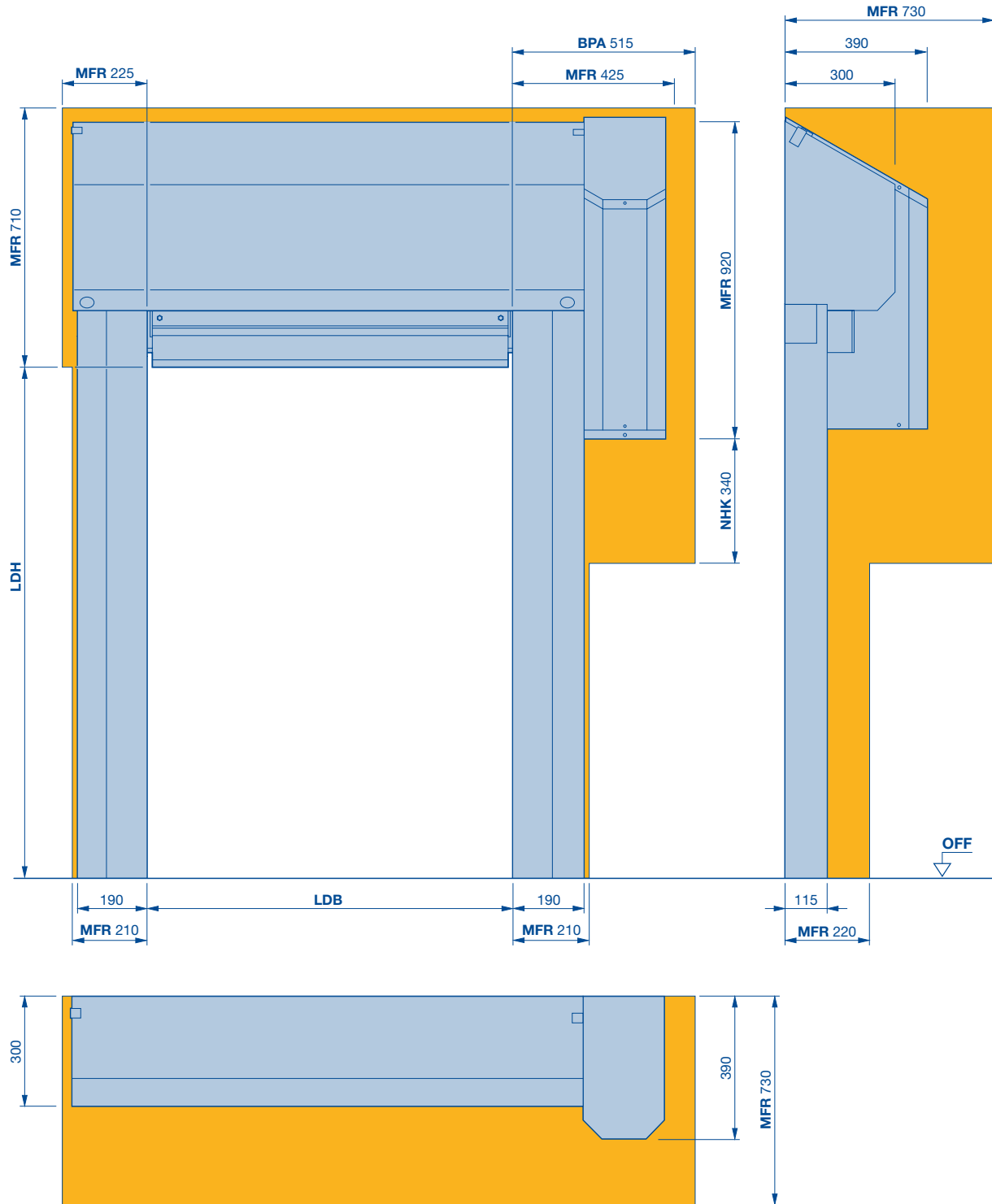

BPA Space required to fit and dismantle the operator
LDB Clear passage width
LDH Clear passage height

MFR Space for fitting the door
NHK Space requirement for emergency crank handle

Notes

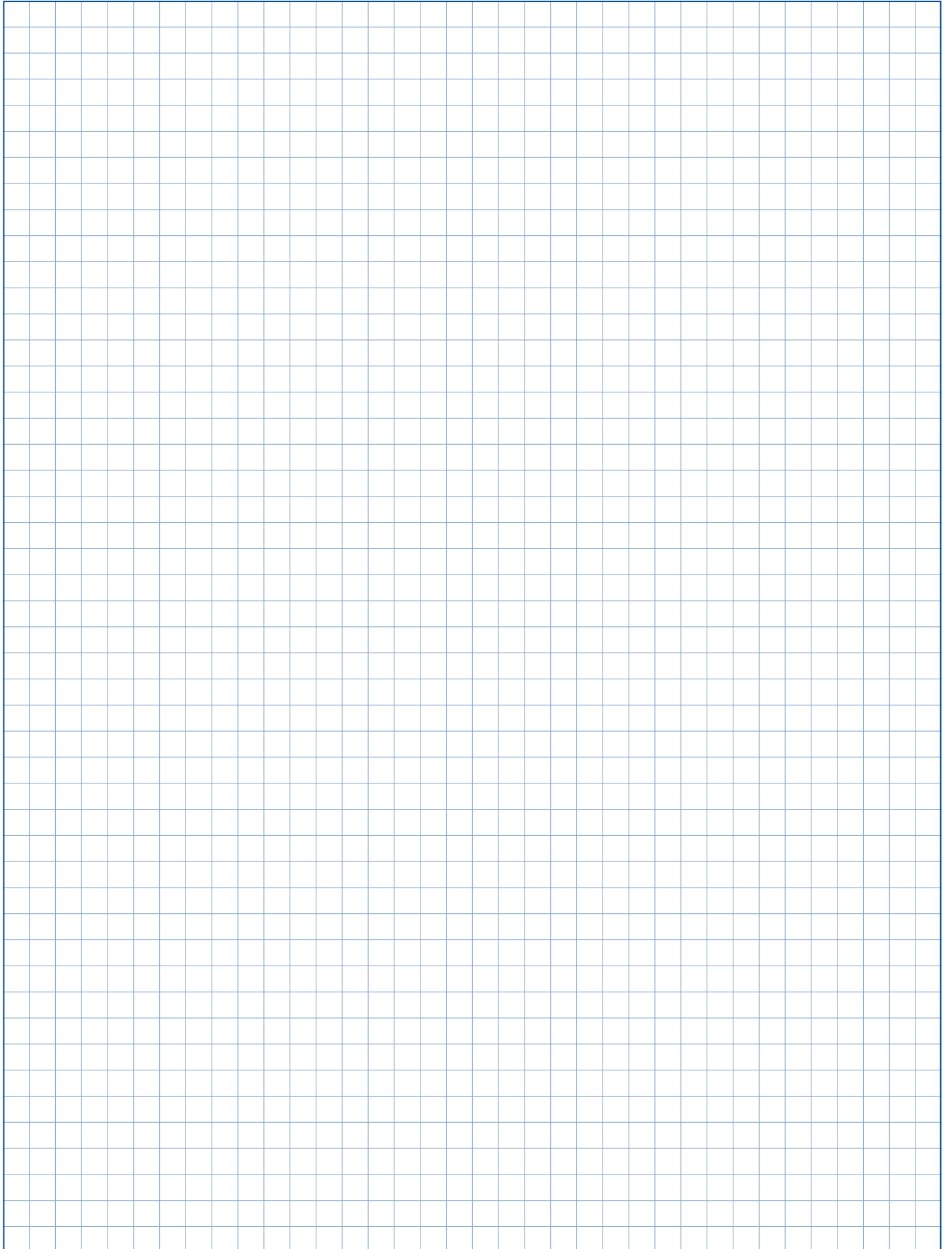

High-speed doors with flexible door leaf

Technical data for external doors and internal doors

Use	Internal door	
	External door	
Door sizes	Maximum width LDB	
	Maximum height LDH	
Speed	FU control, 1-phase	Max. opening approx. m/s
	FU control, 3-phase	Max. opening approx. m/s
Security features	EN 13241	
Wind load resistance	EN 12424	LDB ≤ 4000 mm
		LDB > 4000 mm, ≤ 5000 mm
		LDB > 5000 mm
Door construction	Self-supporting	
Door leaf material and surface	Galvanized steel	
	Galvanized steel, coated, in colours based on RAL	
	Polished stainless steel V2 A	
Operator cover and shaft cover	Straight	
	30 chamfered (5)	
Door leaf	Fabric, transparent	1.5/2.0 mm
		2.4/4.0 mm
	Transparent	4.0 mm
	Aluminium/spring steel wind lock	
	Door leaf tension	
SoftEdge, aluminium bottom profile		
Operator and control	Frequency converter	
	Connecting voltage	1-phase, 1–230 V, N, PE
		3-phase, 3–400 V, N, PE
	Open-Stop-Close button	
	Main switch, all-pole switch-off	1-phase
		3-phase
	Emergency-off button	1-phase
		3-phase
	Fuse protection	1-phase, 3-phase
	Protection category for control	
	Protection category for operator	
	Closing zone monitoring	Safety light grille IP 67
		Closing edge safety device and photocell
	Hold-open phase, in sec.	
	Electronic limit switch DES	
Emergency opening	Crank handle	
	Emergency hand chain	
	UPS in plastic cabinet for FU control 230 V, 1-phase	
Volt-free contacts		
Plug-in control wiring		

● = Standard

○ = Optional

V 6030 SEL	V 6020 TRL	V 10008
●	●	●
●	●	●
5000	6000	10000
6000	7000	6250
2,0	2,0	—
2,0	2,0	1.5/0.8 1)
●	●	●
Class 2	Class 2	Class 4
Class 2	Class 2	Class 3
Class 2	Class 2	Class 2
●	—	—
●	●	●
0	0	0
0	0	—
0	0	—
0	0	(0)
●	—	●
—	0	—
—	●	—
-/●	-/●	-/●
●	●	●
●/0	-/●	-/●
●	●	●
●	●	—
0	●/0	●
●	●	●
0	0	—
●	●	●
0	0	—
●	●	●
16 A, slow-acting	16 A, slow-acting	16 A, slow-acting
IP 65	IP 65	IP 65
IP 54	IP 54	IP 54
●	●	—
—	—	●
1-200	1-200	1-200
●	●	●
●	●	—
0	0	●
0	0	—
3	3	3
●	●	—

1) If LB > 6000 mm

High-speed doors with flexible door leaf V 6030 SEL

With SoftEdge and anti-crash

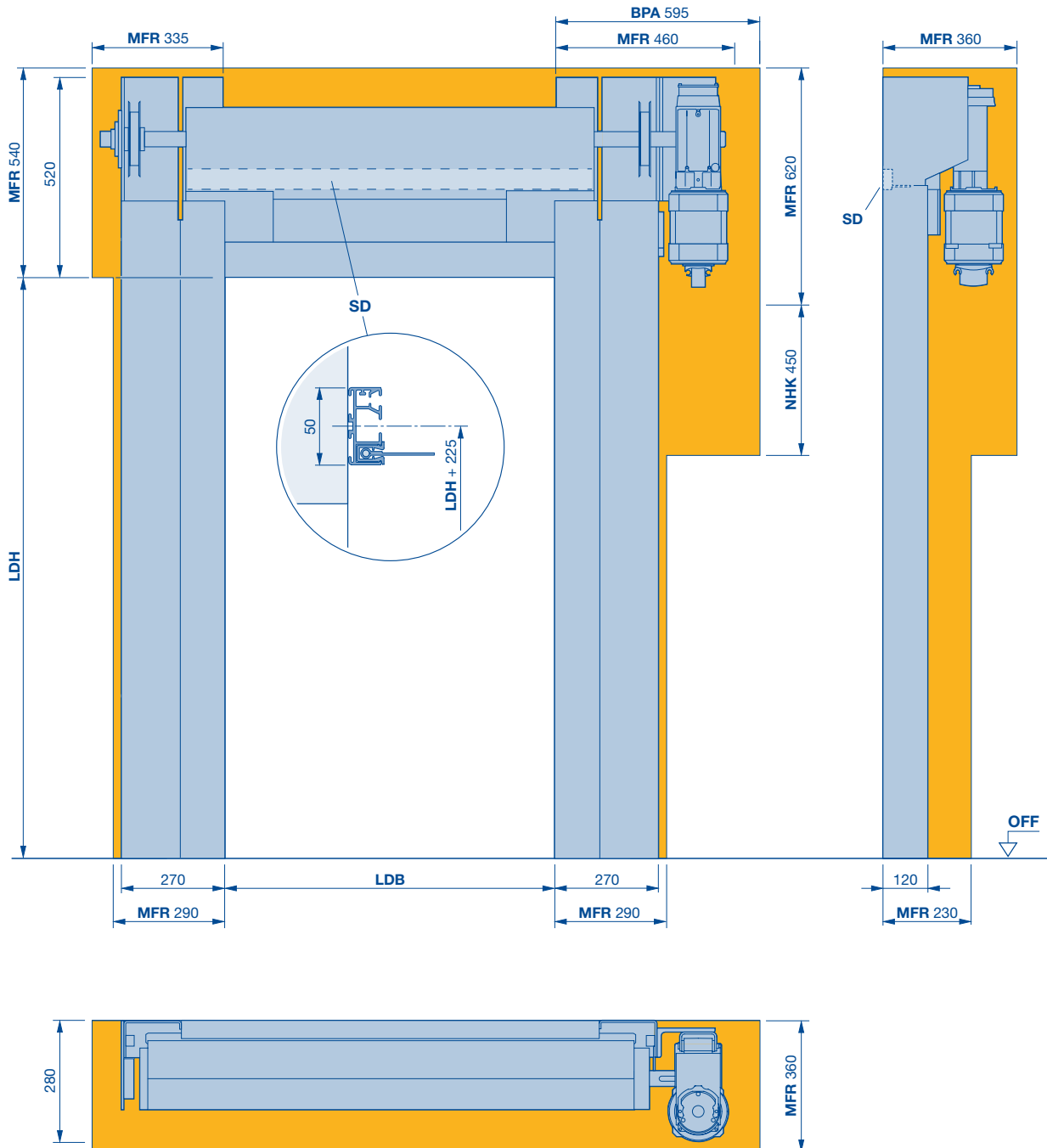

BPA Space required to fit and dismantle the operator
LDB Clear passage width
LDH Clear passage height

MFR Space for fitting the door
NHK Space requirement for emergency crank handle
SD Lintel seal

High-speed doors with flexible door leaf V 6030 SEL

With SoftEdge and anti-crash

Curtain fixing

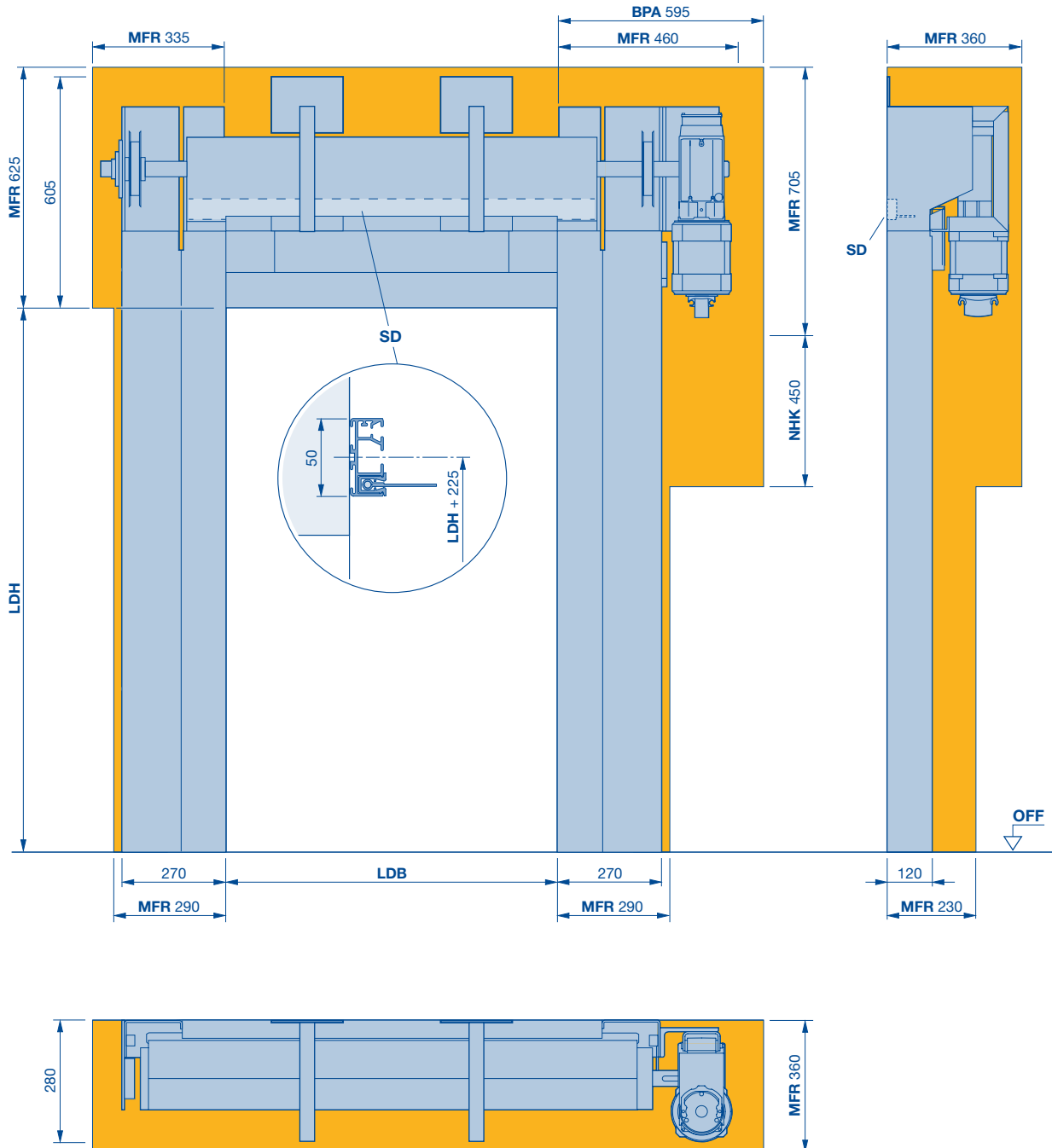

BPA Space required to fit and dismantle the operator
LDB Clear passage width
LDH Clear passage height

MFR Space for fitting the door
NHK Space requirement for emergency crank handle
SD Lintel seal

High-speed doors with flexible door leaf V 6030 SEL

With SoftEdge and anti-crash

Full cladding, straight

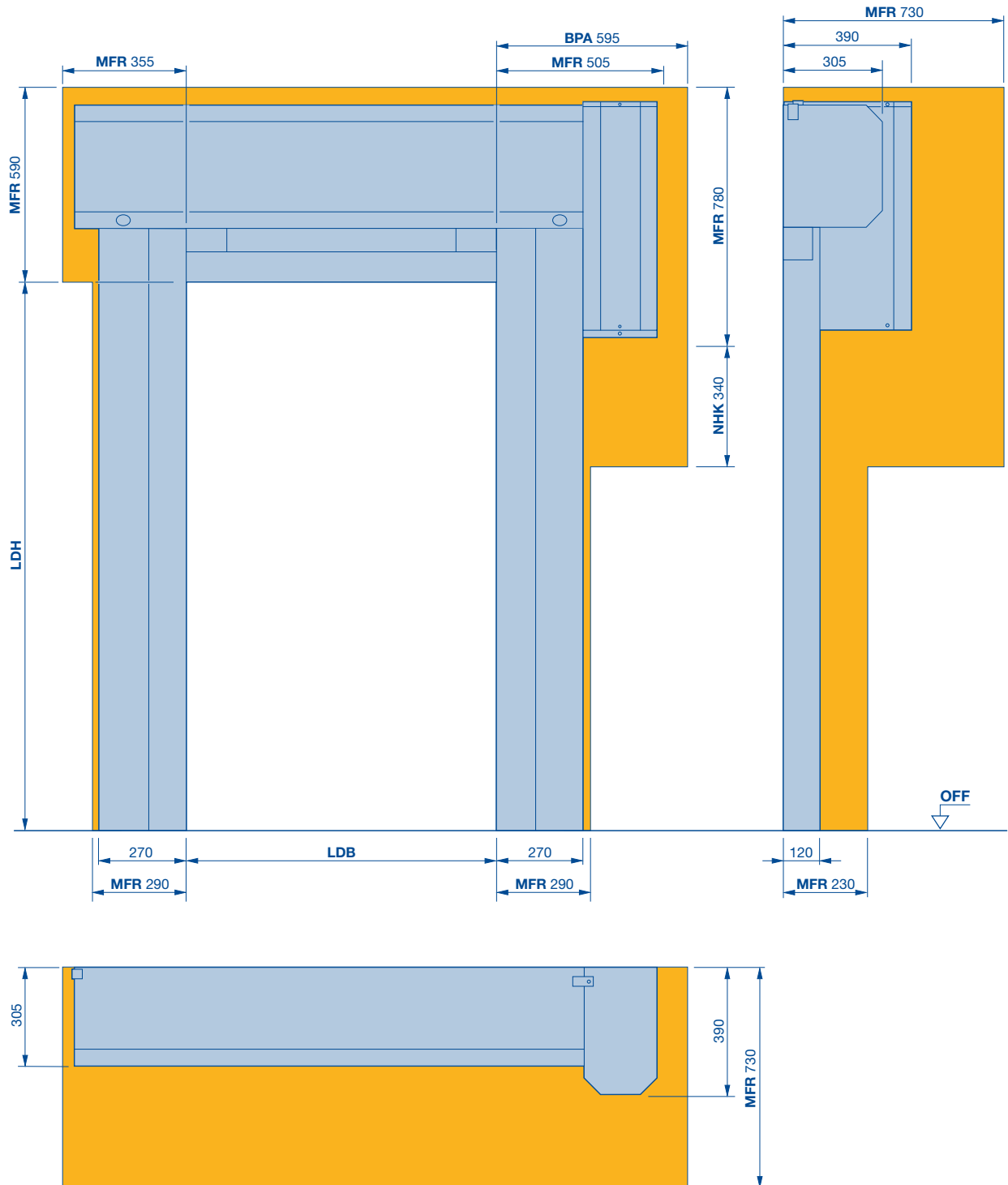

BPA Space required to fit and dismantle the operator
LDB Clear passage width
LDH Clear passage height

MFR Space for fitting the door
NHK Space requirement for emergency crank handle

High-speed doors with flexible door leaf V 6030 SEL

With SoftEdge and anti-crash

Full cladding, chamfered

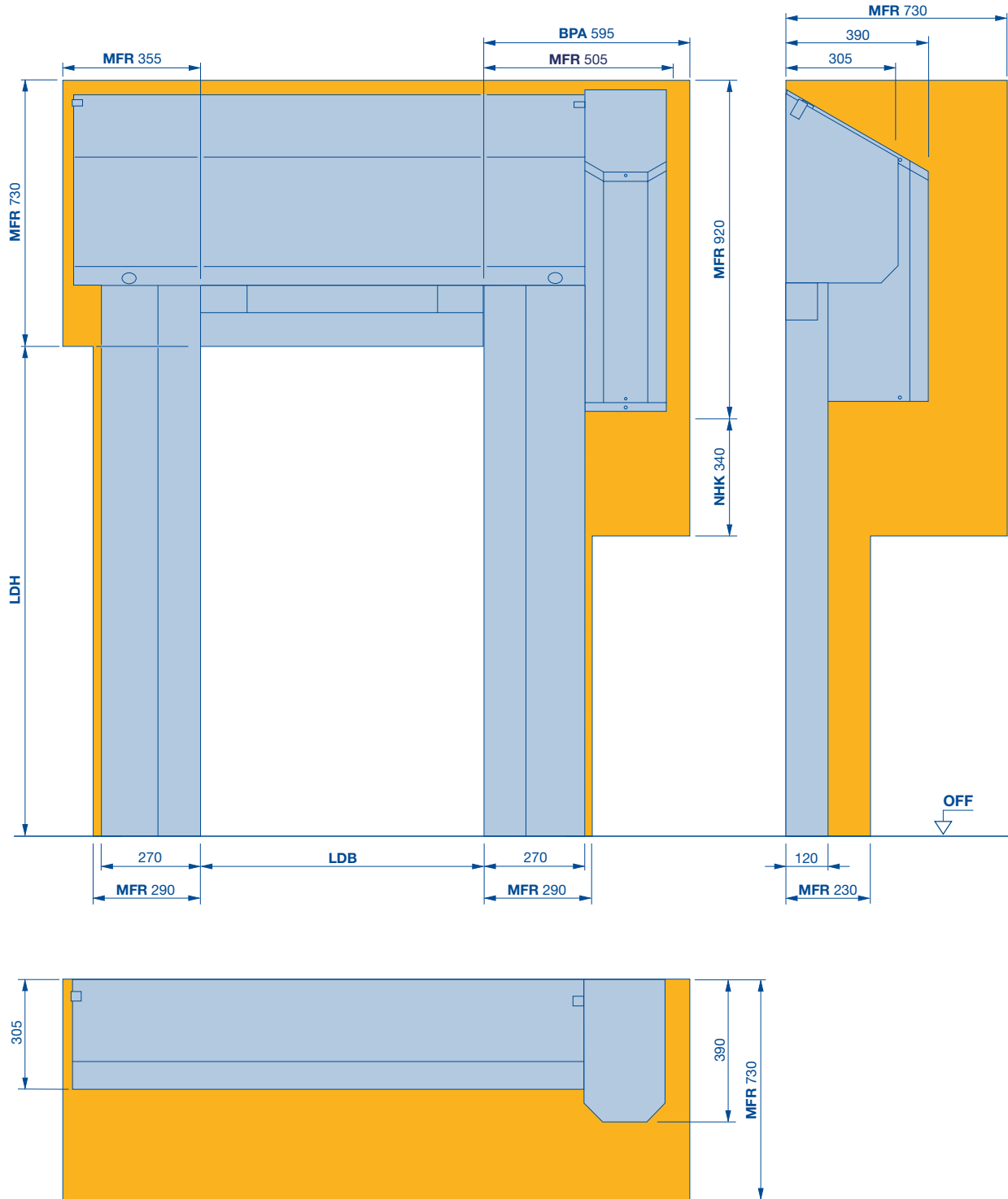

BPA Space required to fit and dismantle the operator
LDB Clear passage width
LDH Clear passage height

MFR Space for fitting the door
NHK Space requirement for emergency crank handle

High-speed doors with flexible door leaf V 6020 TRL

Fully transparent

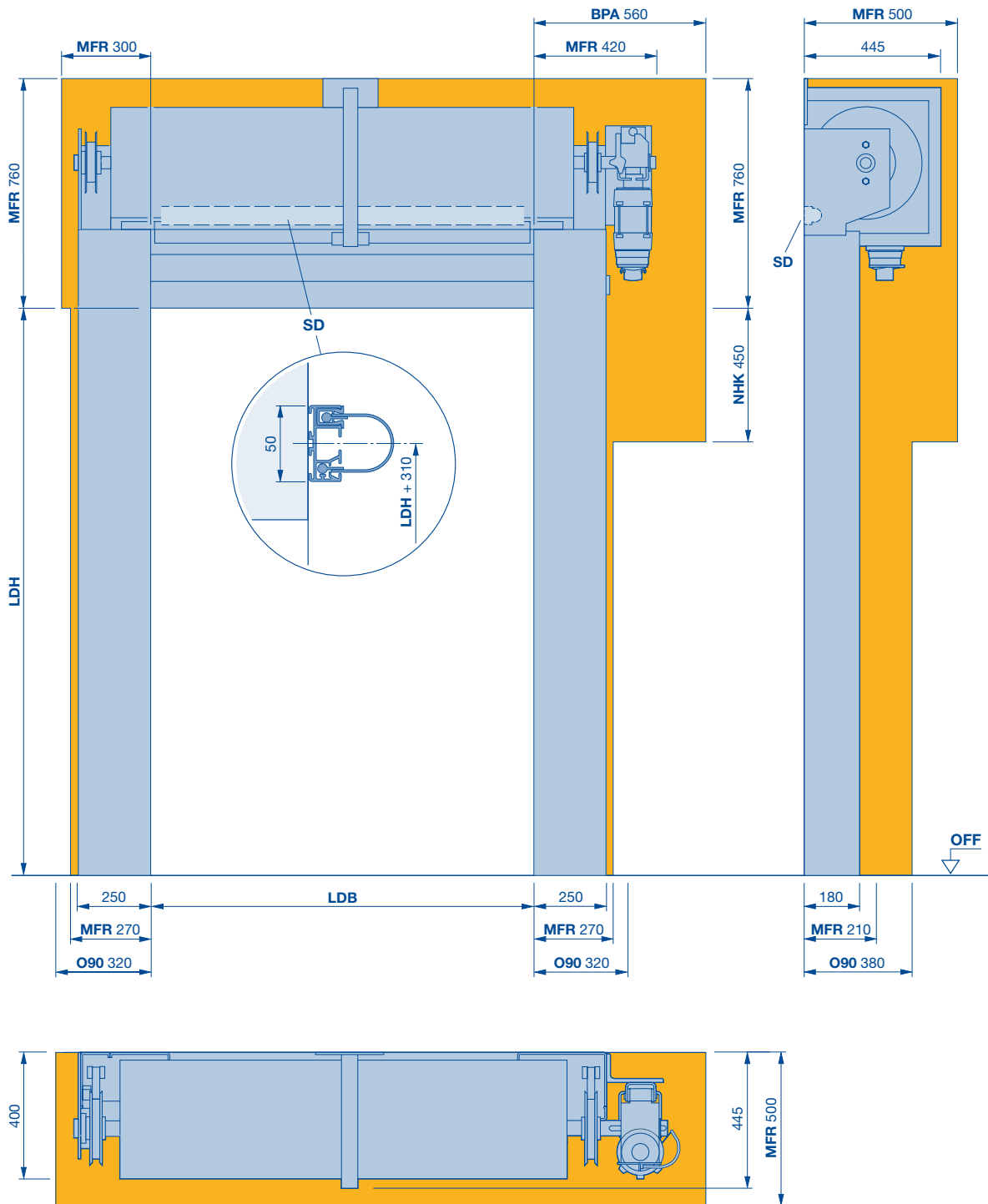

BPA Space required to fit and dismantle the operator
LDB Clear passage width
LDH Clear passage height

MFR Space for fitting the door
NHK Space requirement for emergency crank handle
O90 For opening 90°

SD Lintel seal

High-speed doors with flexible door leaf V 6020 TRL

Fully transparent

Full cladding, straight

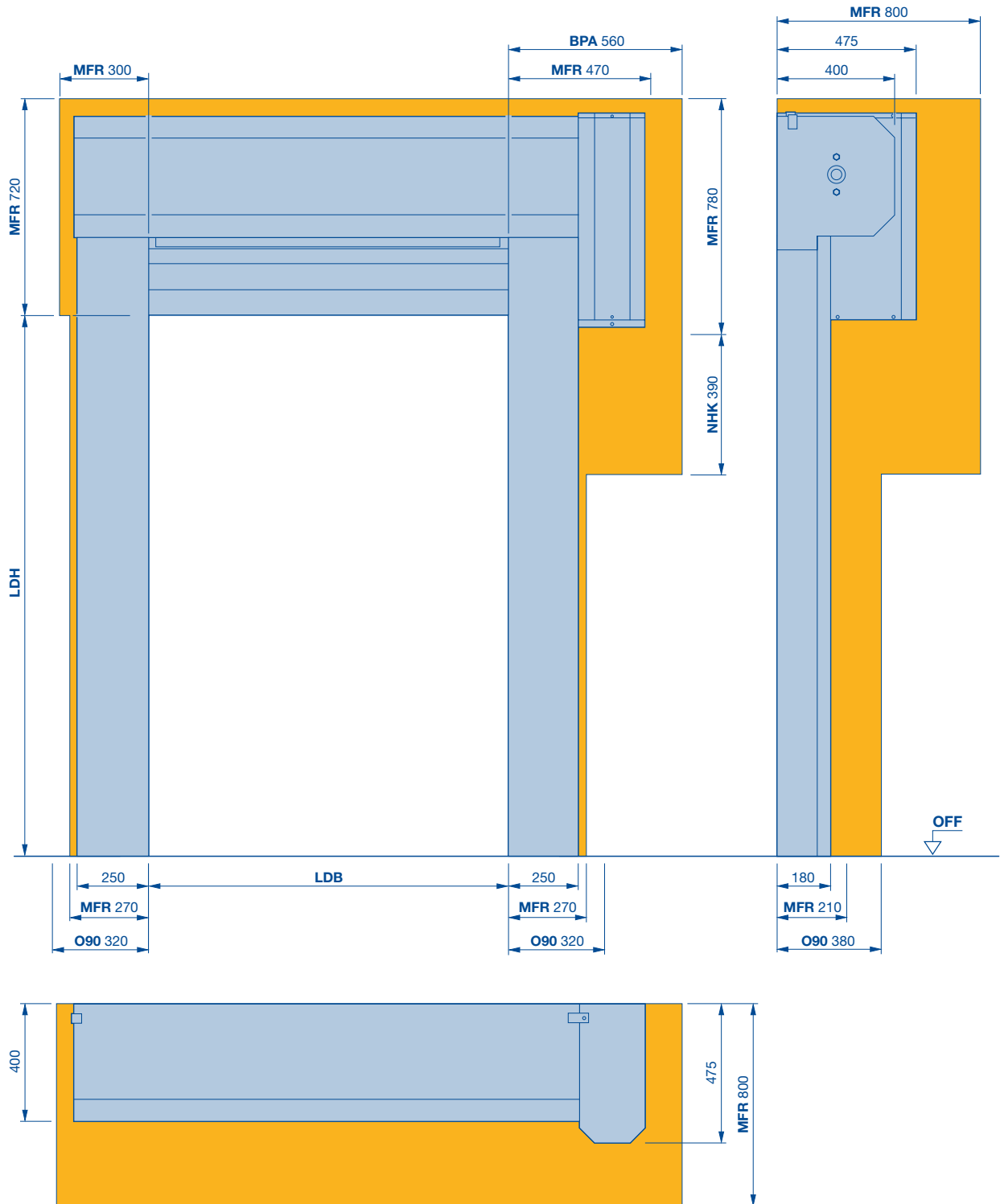

BPA Space required to fit and dismantle the operator
LDB Clear passage width
LDH Clear passage height

MFR Space for fitting the door
NHK Space requirement for emergency crank handle
O90 For opening 90°

High-speed doors with flexible door leaf V 6020 TRL

Fully transparent

Full cladding, chamfered

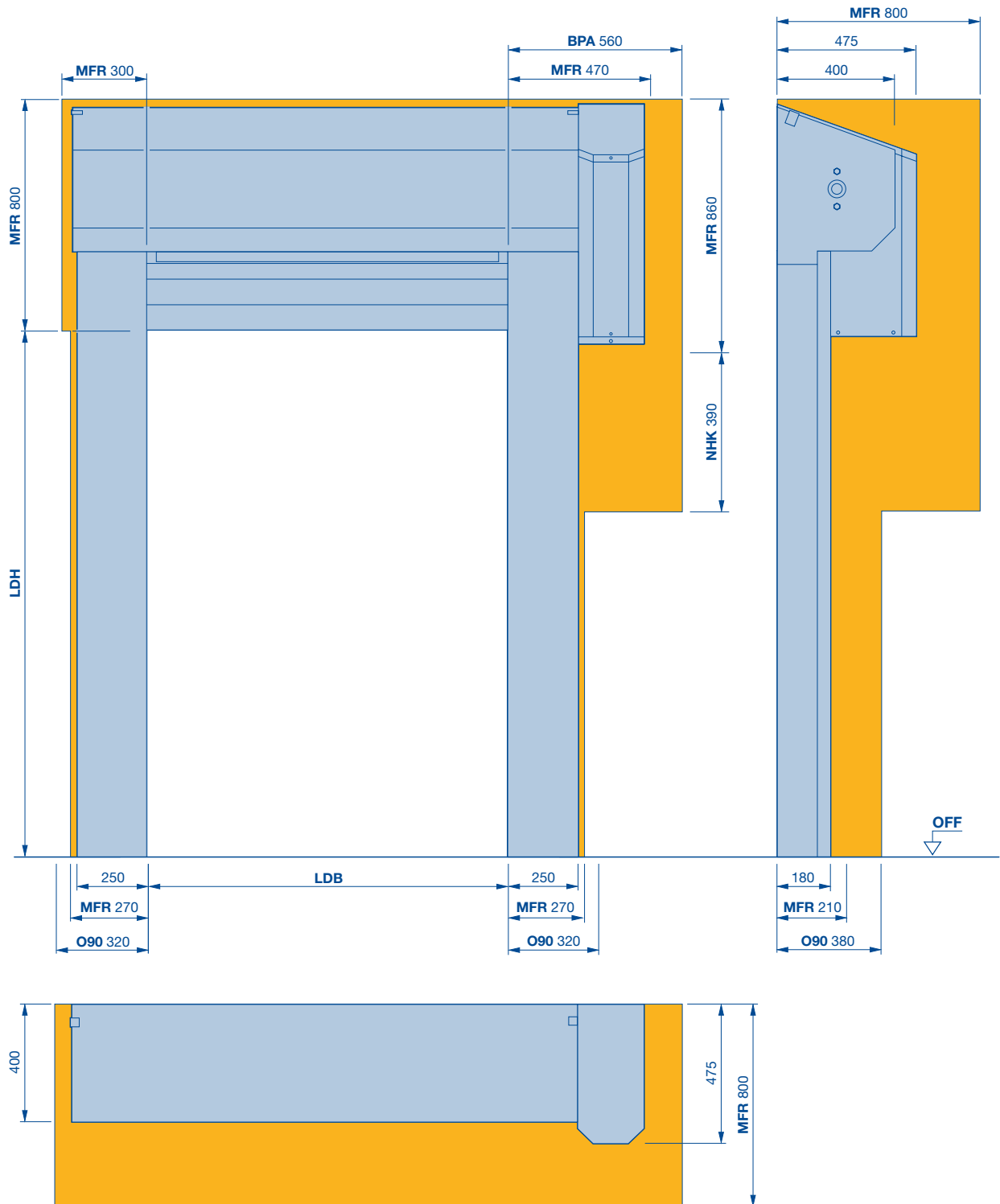

BPA Space required to fit and dismantle the operator
LDB Clear passage width
LDH Clear passage height

MFR Space for fitting the door
NHK Space requirement for emergency crank handle
O90 For opening 90°

High-speed doors with flexible door leaf V 10008

Large door

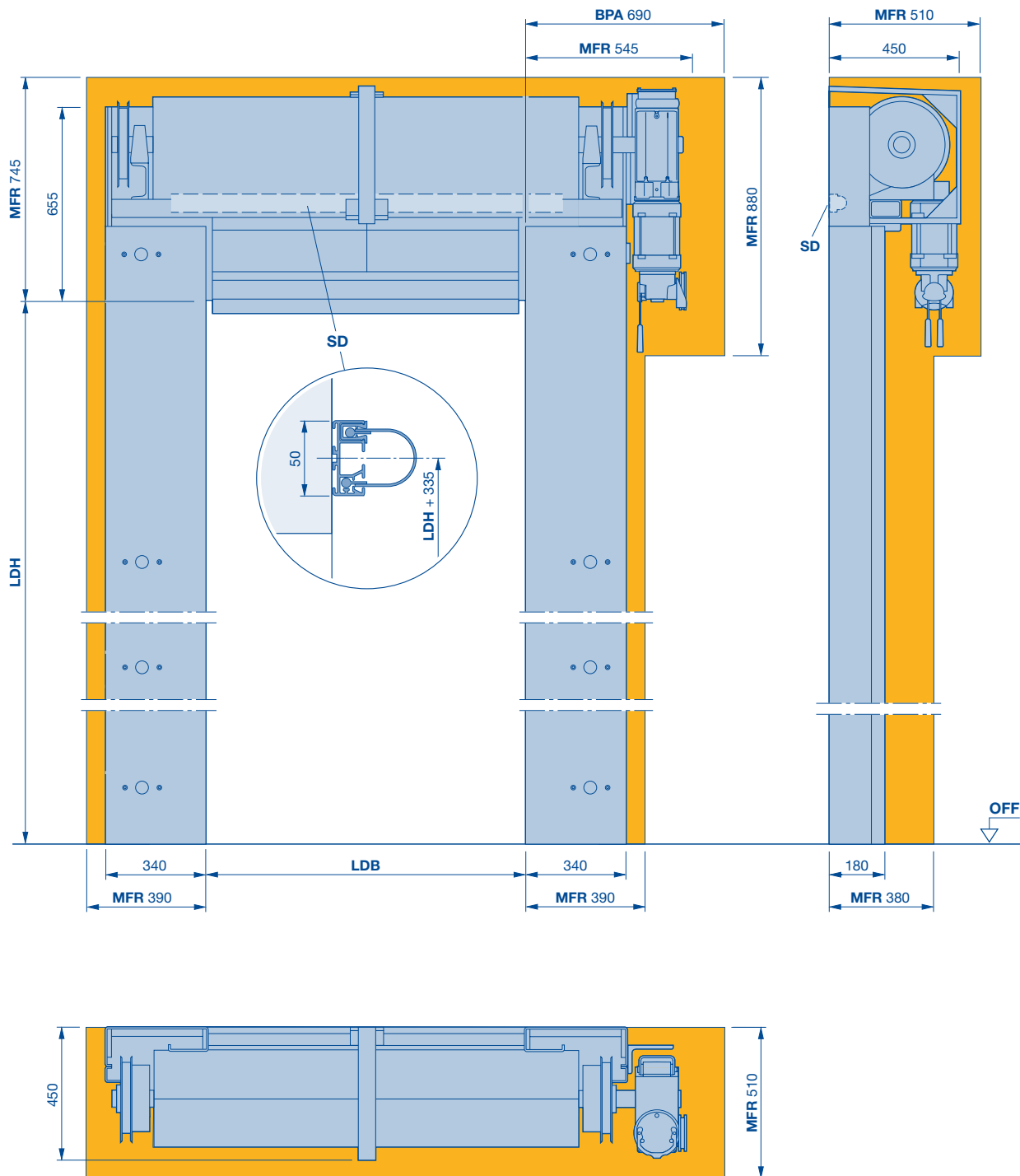

BPA Space required to fit and dismantle the operator

LDB Clear passage width

LDH Clear passage height

MFR Space for fitting the door

SD Lintel seal

High-speed doors with flexible door leaf V 10008

Large door

Full cladding

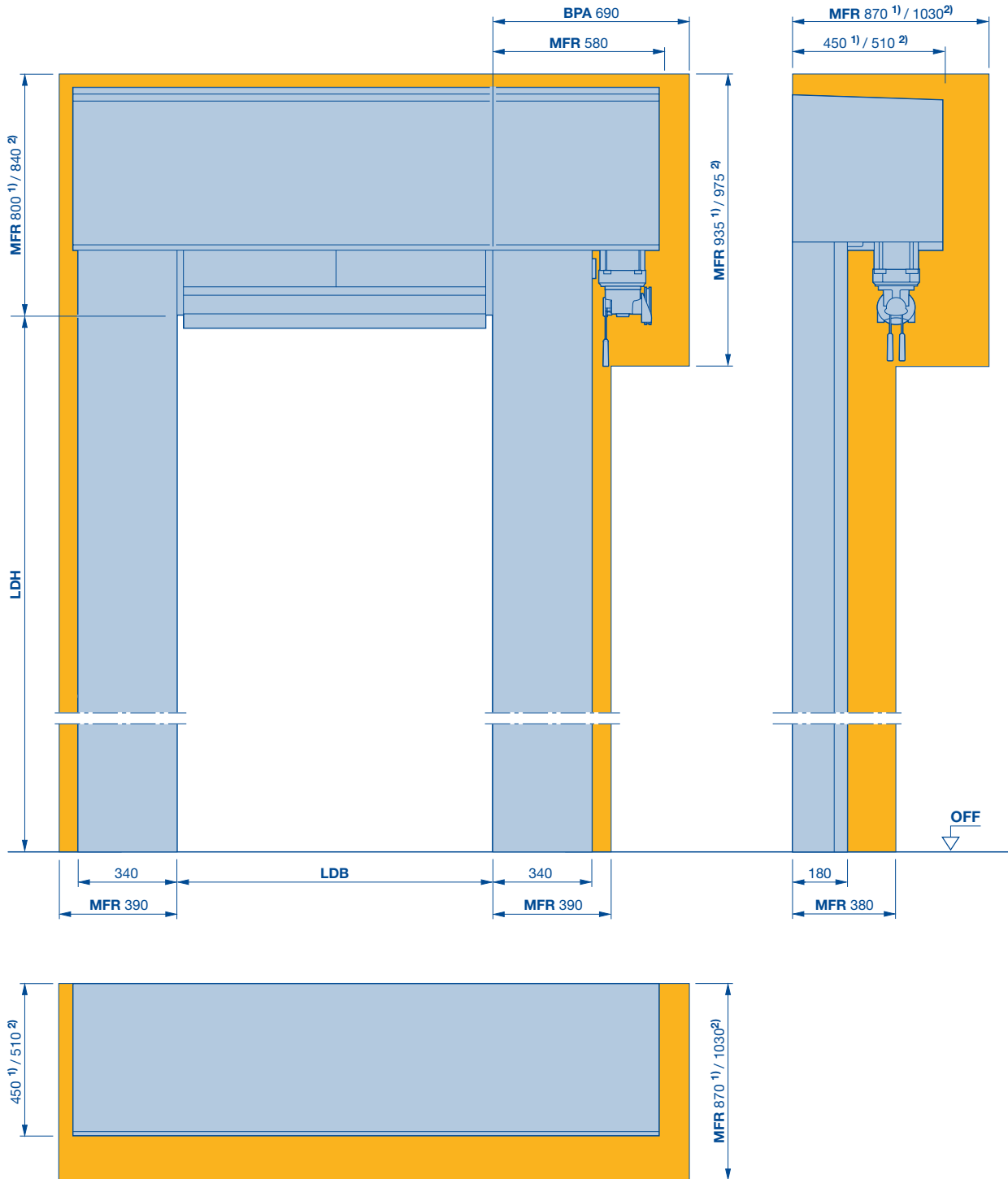

1) $LDB \leq 7300$ and $LDH \leq 6500$

2) $LDB > 7300$ or $LDH > 6500$

MFR Space required to fit and dismantle the operator

LDB Clear passage width

LDH Clear passage height

MFR Space for fitting the door

Notes

A large grid area for taking notes, consisting of many small squares. The grid is composed of 20 columns and 40 rows of small squares, providing a structured space for writing or drawing.

Internal doors for special applications

Technical data

Use	Internal door	
	External door	
Door sizes	Maximum width LDB	
	Maximum height LDH	
	FU control, 1-phase	Max. opening approx. m/s
		Max. closing approx. m/s
Security features	EN 13241	
Wind load resistance	EN 12424	
Thermal insulation	EN 13241-1, ISO 12567-1	
Door construction	Self-supporting	
Door leaf material and surface	Galvanized steel	
	Galvanized steel, coated, in colours based on RAL	
	Polished stainless steel V2 A	
Operator cover and shaft cover	Straight	
	5 chamfered	
Door leaf	Fabric, transparent	1.5/2.0 mm
	Transparent	4.0 mm
	Insulating curtain, curtain pockets with 20 mm thick PE foam infill	
	Aluminium/spring steel wind lock	
SoftEdge, aluminium bottom profile		
Operator and control	Frequency converter	
	Connecting voltage	1-phase, 1 – 230 V, N, PE
	Open-Stop-Close button	
	Main switch, all-pole switch-off	1-phase
	Emergency-off button	1-phase
	Fuse protection	1-phase
	Protection category for control	
	Protection category for operator	
	Closing zone monitoring	Safety light grille IP 67
		Closing edge safety device and photocell
		Light grille
	Hold-open phase, in sec.	
	Electronic limit switch DES	
Emergency opening	Emergency crank handle	
	Counter weight and operating current brake	
	UPS in plastic cabinet for FU control 230 V, 1-phase	
Volt-free contacts		
Plug-in control wiring		

● = Standard

○ = Optional

V 4015 Iso L	V 2515 Food L	V 2012	V 3015 Clean
●	●	●	●
—	—	—	—
4000	2500	2500	2500
4500	4000	2500	3000
1,5	1,2	1,2	1,5
0,5	0,5	0,5	0,5
●	●	●	●
npd	npd	npd	npd
1,6	—	—	—
—	●	●	●
●	—	●	—
0	—	0	—
0	●	0	●
—	—	●	—
0	●	—	●
—	●	●	—
—	—	—	●
●	—	—	—
●/-	-/●	-/●	-/●
-/●	●/-	●/-	-/●
●	●	●	●
●	●	●	●
●	●	●	●
0	●	●	●
0	●	●	●
16 A, slow-acting	16 A, slow-acting	16 A, slow-acting	16 A, slow-acting
IP 65	IP 65	IP 65	IP 65
IP 54	IP 65	IP 54	IP 54
●	●	—	—
—	—	—	●
—	—	●	—
1-200	1-200	1-200	1-200
●	●	●	●
●	—	●	●
—	—	●	—
0	0	—	0
3	3	3	3
●	●	—	—

High-speed doors for special applications V 4015 Iso L

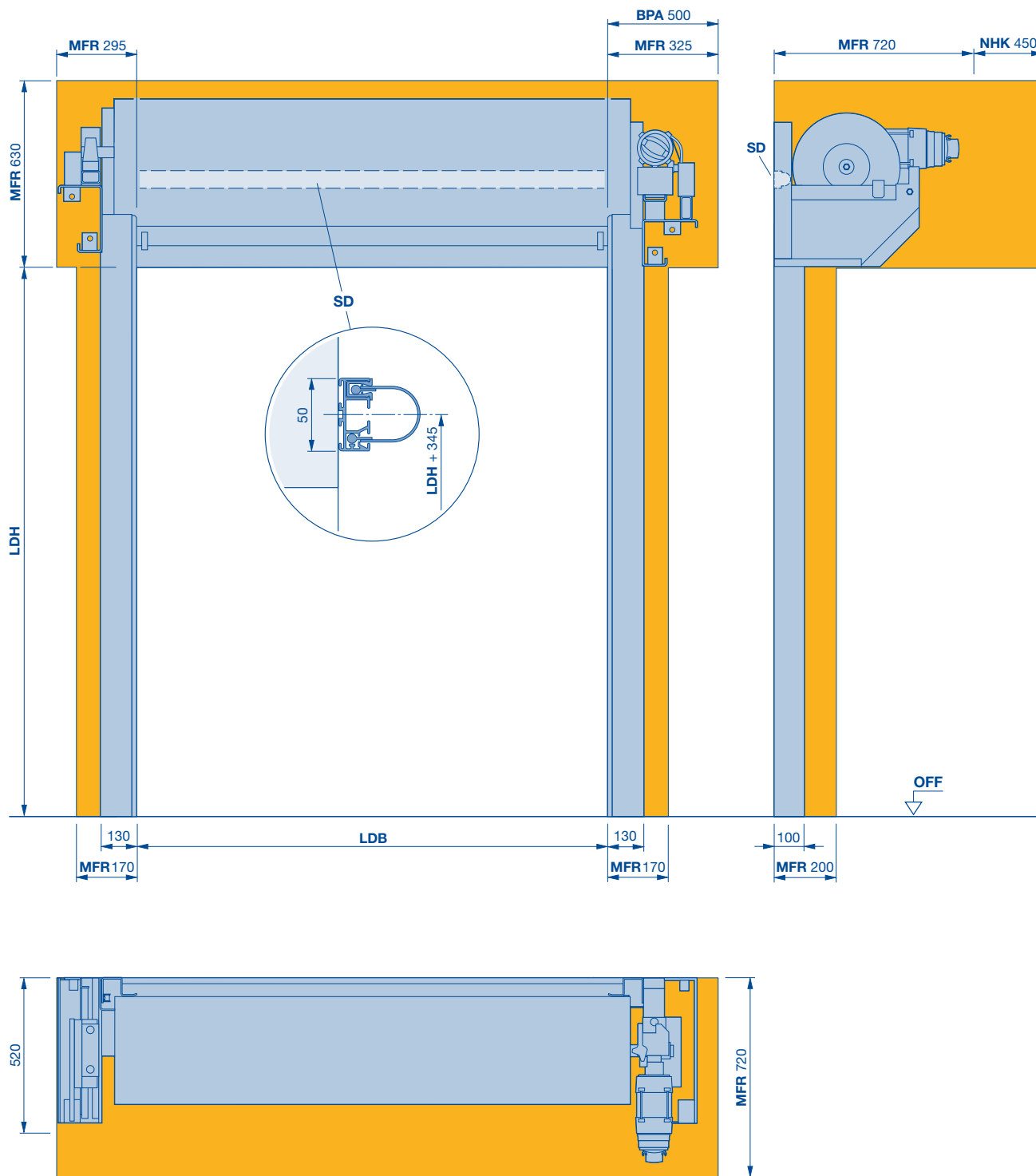

BPA Space required to fit and dismantle the operator
LDB Clear passage width
LDH Clear passage height

MFR Space for fitting the door
NHK Space requirement for emergency crank handle
SD Lintel seal

High-speed doors for special applications V 4015 Iso L

Full cladding, chamfered

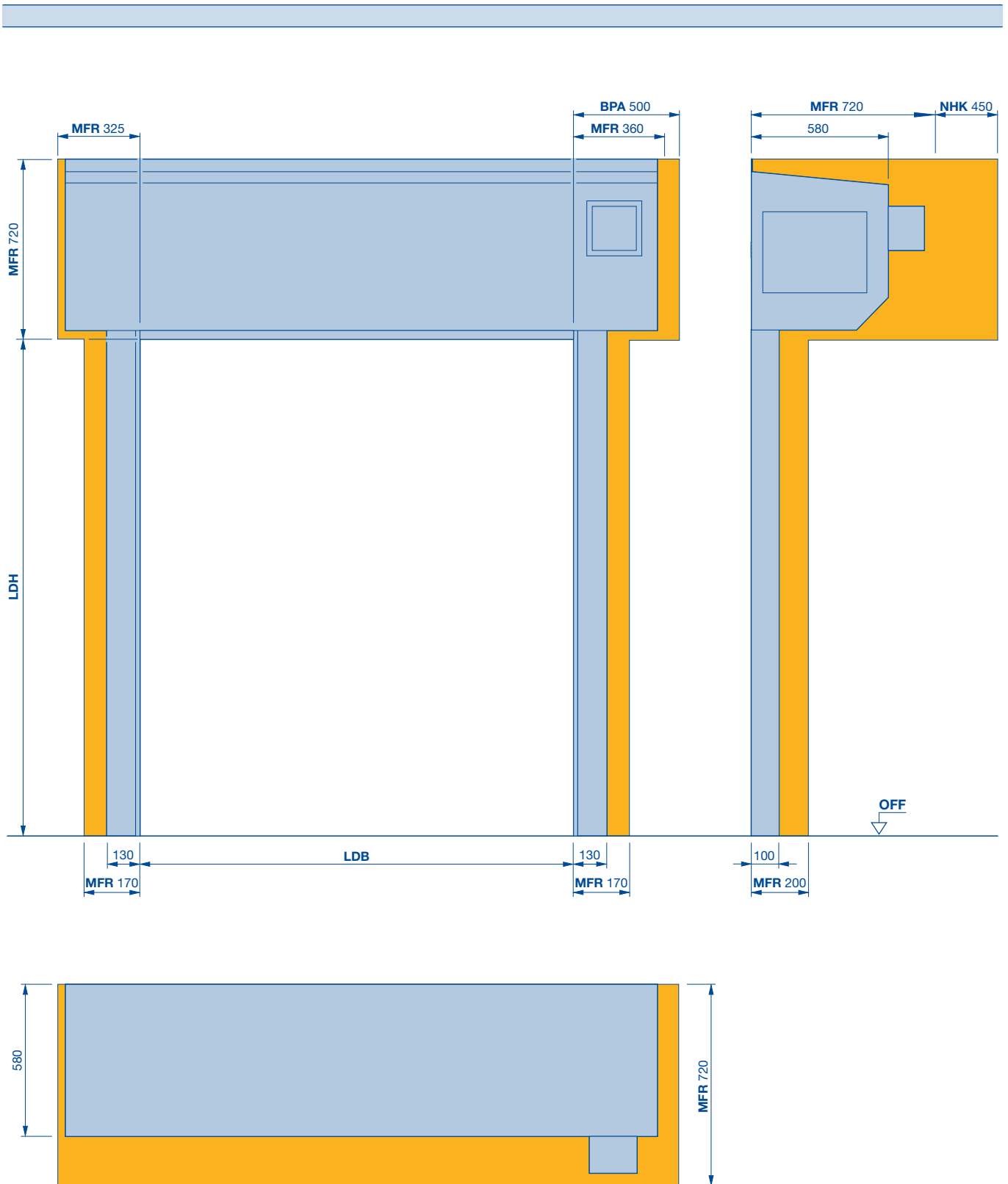

BPA Space required to fit and dismantle the operator
LDB Clear passage width
LDH Clear passage height

MFR Space for fitting the door
NHK Space requirement for emergency crank handle

High-speed doors for special applications V 2515 Food L

Food industry

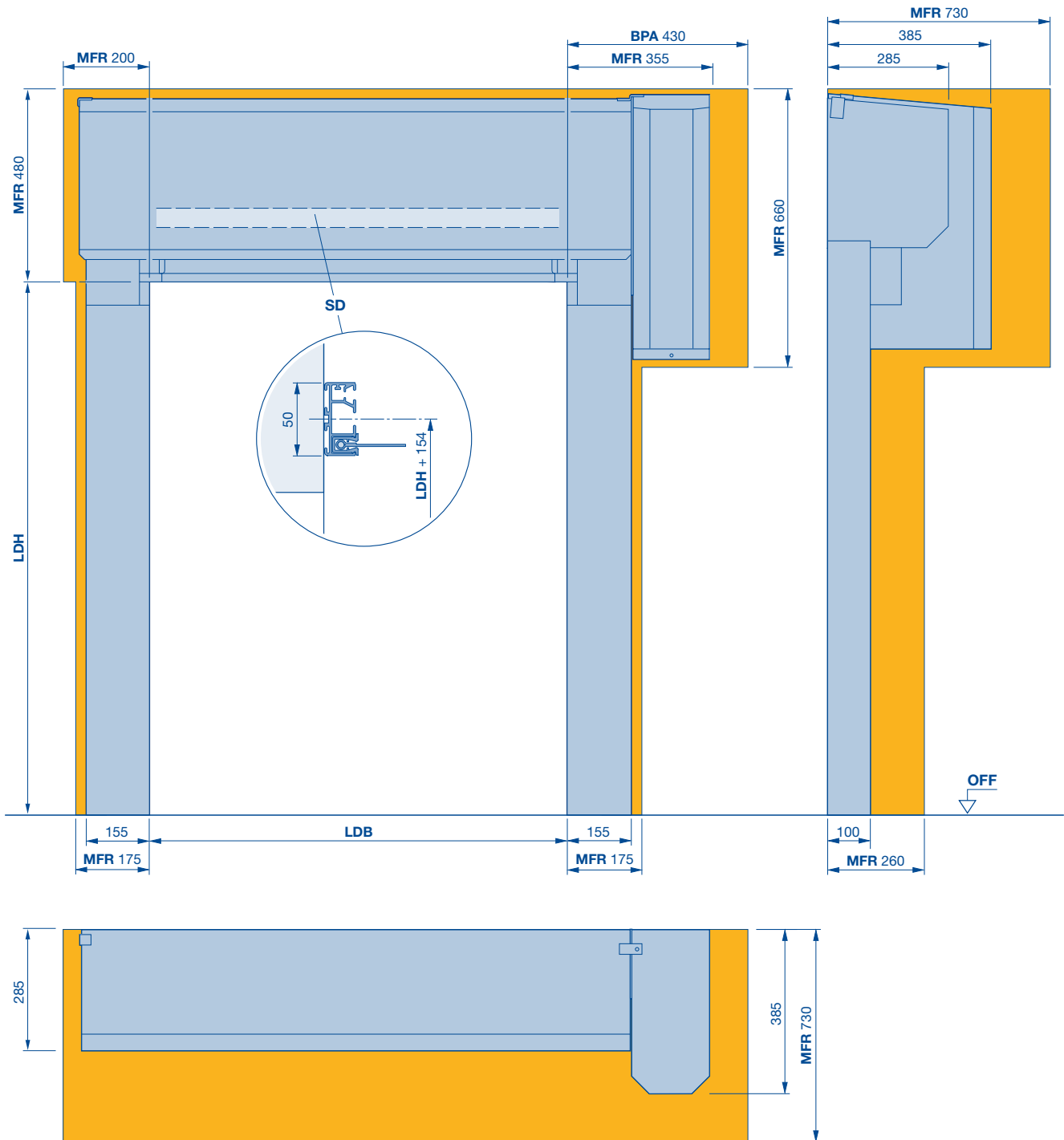

BPA Space required to fit and dismantle the operator
LDB Clear passage width
LDH Clear passage height

MFR Space for fitting the door
SD Lintel seal

High-speed doors for special applications V 2012

Supermarket door

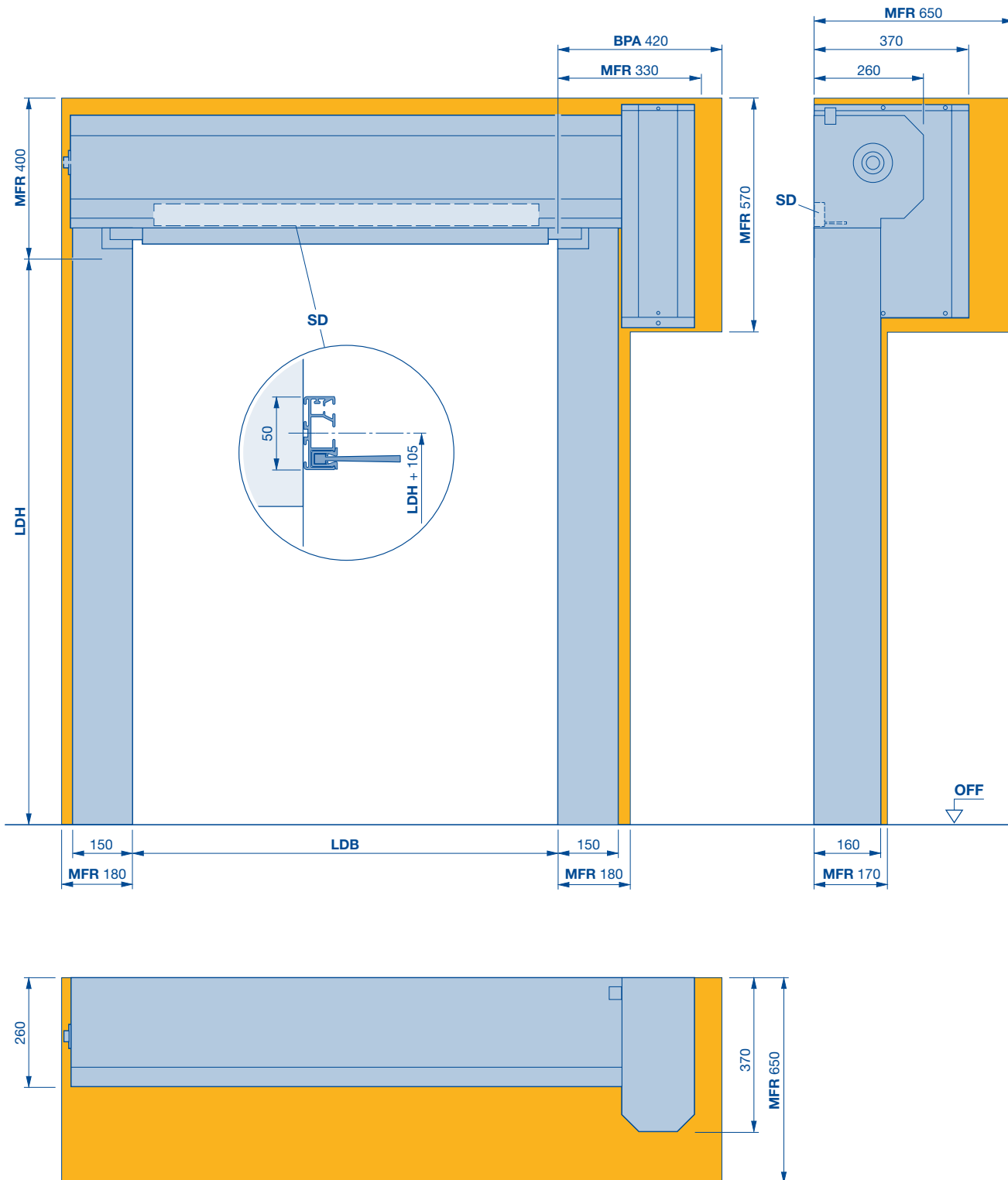

BPA Space required to fit and dismantle the operator

MFR Space for fitting the door

LDB Clear passage width

SD Lintel seal

LDH Clear passage height

High-speed doors for special applications V 3015 Clean

Clean rooms

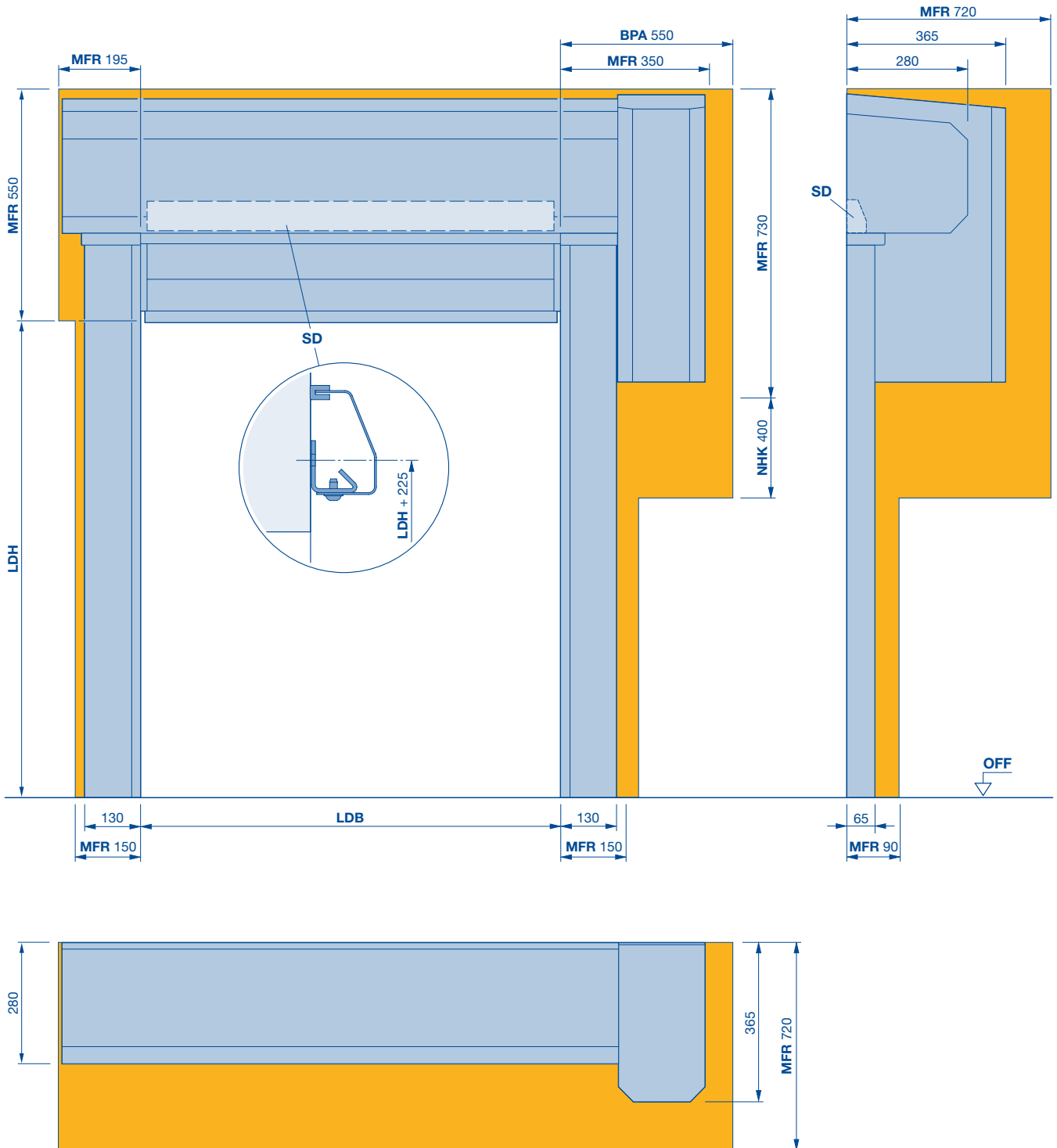

BPA Space required to fit and dismantle the operator
LDB Clear passage width
LDH Clear passage height

MFR Space for fitting the door
NHK Space requirement for emergency crank handle
SD Lintel seal

Notes

A large grid area for taking notes, consisting of many small squares. The grid is composed of 20 columns and 40 rows of small squares, providing a structured space for handwritten notes or diagrams.

Internal doors for individual requirements

Technical data

Use	Internal door		
	External door		
Door sizes	Maximum width LDB		
	Maximum height LDH		
Speed	FU control, 1-phase	Max. opening approx. m/s	
	FU control, 3-phase	Max. opening approx. m/s	
	Relay control unit, 3-phase	Max. opening approx. m/s	
		Max. closing approx. m/s	
Security features	EN 13241		
Wind load resistance	EN 12424		
Thermal insulation	EN 12428		
Door construction	Self-supporting		
Door leaf material and surface	Galvanized steel		
	Galvanized steel, coated, in colours based on RAL		
	Polished stainless steel V2 A		
Operator cover and shaft cover	Straight		
	30 chamfered		
Door leaf	Fabric, transparent	1.5 / 2.0 mm	
		2.4 / 4.0 mm	
	Transparent	4.0 mm	
	Aluminium/spring steel wind lock		
SoftEdge, aluminium bottom profile			
Operator and control	Frequency converter		
	Connecting voltage	1-phase, 1 – 230 V, N, PE 3-phase, 3 – 400 V, N, PE	
	Open-Stop-Close button		
	Main switch with all-pole switch-off	1-phase 3-phase	
	Emergency-off button	1-phase 3-phase	
	Fuse protection	1-phase, 3-phase	
	Protection category for control		
	Protection category for operator		
	Closing zone monitoring	Safety light grille IP 67 Closing edge safety device and photocell	
	Hold-open phase, in sec.		
	Electronic limit switch DES		
	Emergency opening	Emergency crank handle	
		Emergency hand chain	
	UPS in plastic cabinet for FU control 230 V, 1-phase		
Volt-free contacts			
Plug-in control wiring			

● = Standard

○ = Optional

V 5030 MSL	V 3009	V 6030 ATEX
●	●	●
—	—	—
4000	3500	4000
4000	3500	4000
1,5	—	—
1,5	1,2	1,5
—	0,8	—
0,8	0,8	0,8
●	●	●
Class 1	npd	npd
npd	npd	npd
●	●	●
●	●	●
○	○	—
○	○	○
○	○	○
○	○	○
—	●	●
○	—	—
●	—	—
-/●	●/-	-/●
-/●	-/●	-/●
●	○	●
●	○	●
●	●	—
●	●	●
○	○	●
●	●	—
○	○	●
●	●	—
16 A, slow-acting	16 A, slow-acting	16 A, slow-acting
IP 65	IP 54	IP 65
IP 54	IP 54	IP 65
●	—	—
—	●	●
1-200	1-200	1-200
●	●	●
●	●	●
○	○	—
○	—	—
3	2	8
●	—	—

High-speed doors for individual applications V 5030 MSL

Equipment protection

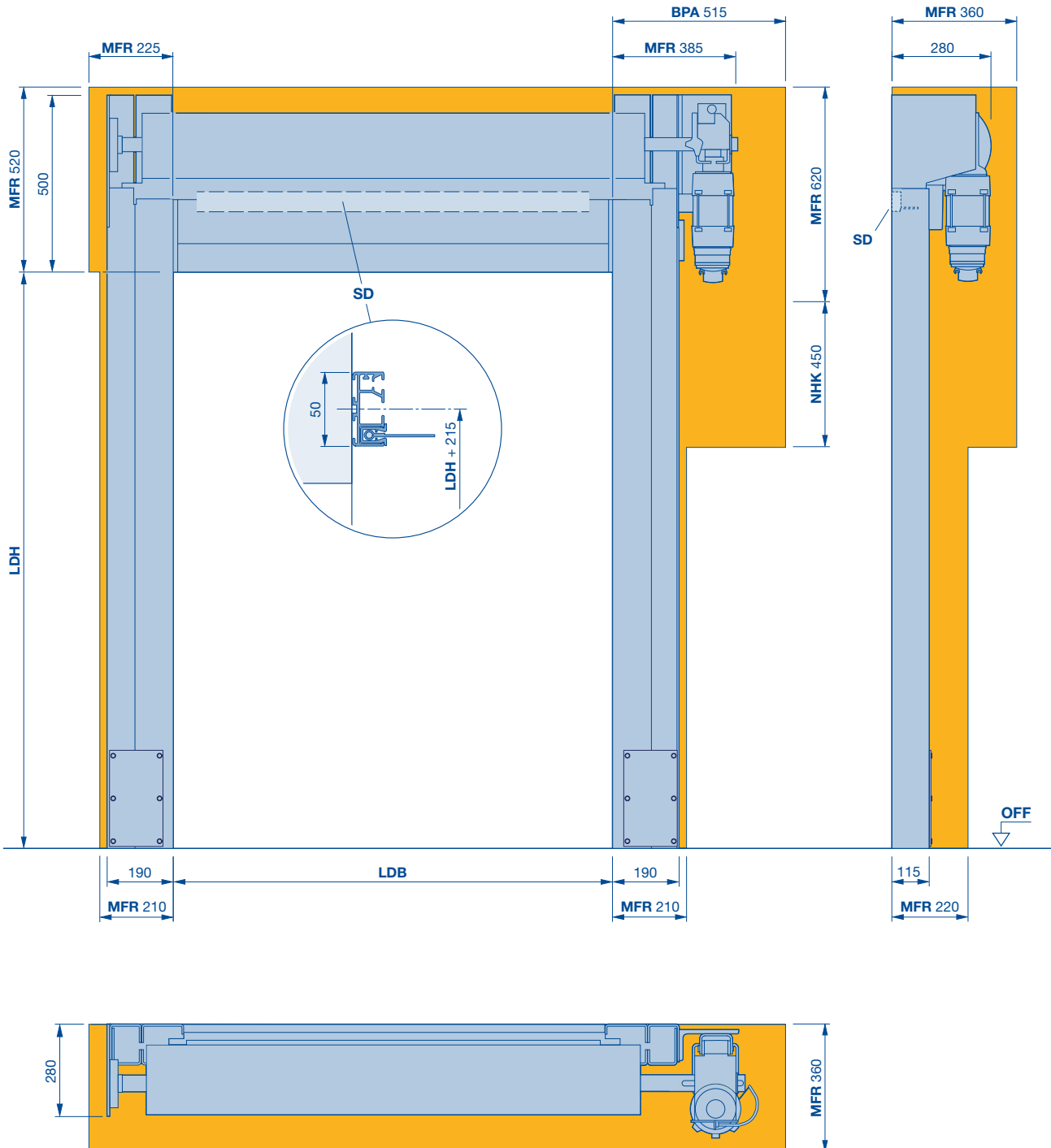

BPA Space required to fit and dismantle the operator
LDB Clear passage width
LDH Clear passage height

MFR Space for fitting the door
NHK Space requirement for emergency crank handle
SD Lintel seal

High-speed doors for individual applications V 5030 MSL

Equipment protection

Full cladding, straight

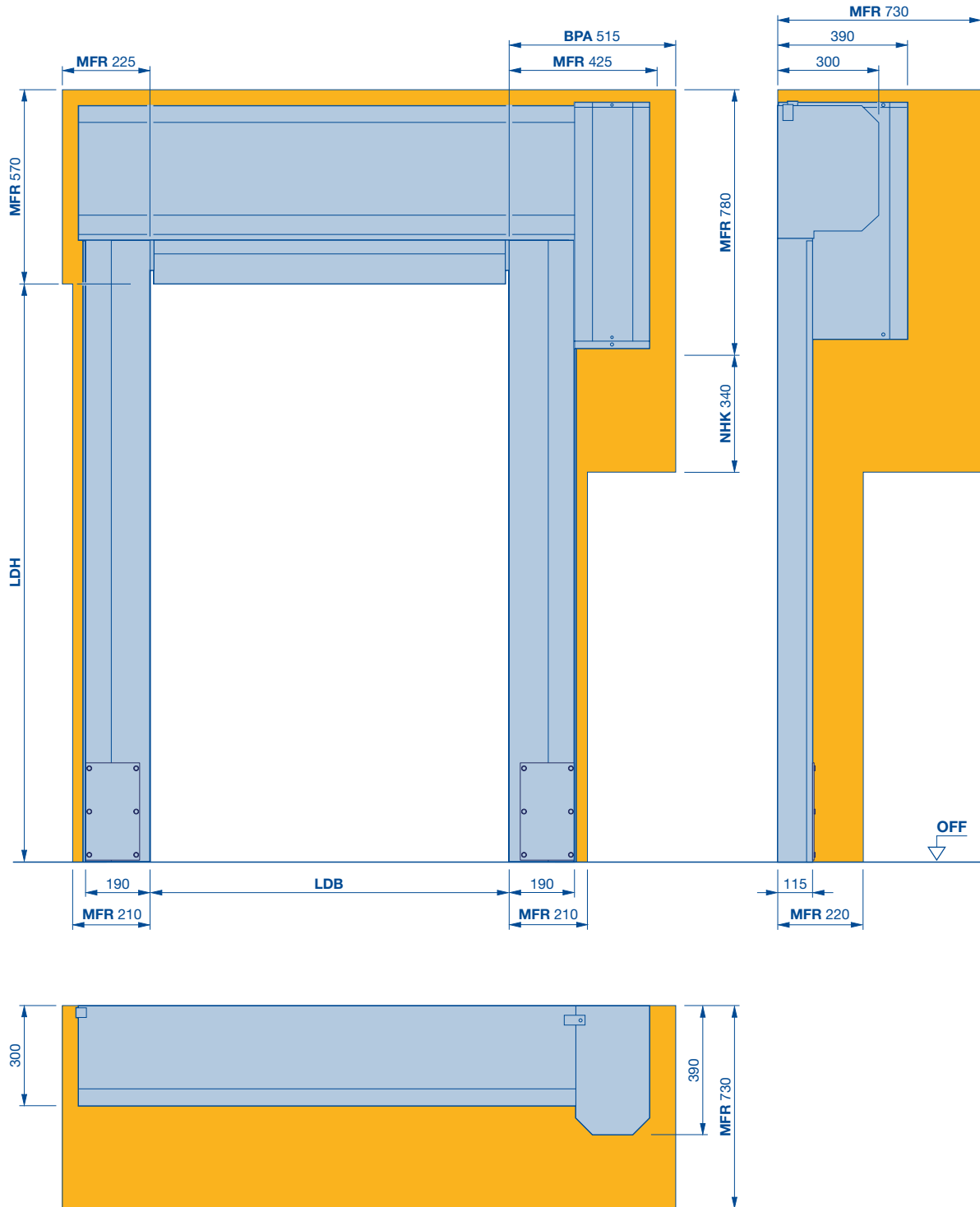

BPA Space required to fit and dismantle the operator
LDB Clear passage width
LDH Clear passage height

MFR Space for fitting the door
NHK Space requirement for emergency crank handle

High-speed doors for individual applications V 5030 MSL

Equipment protection

Full cladding, chamfered

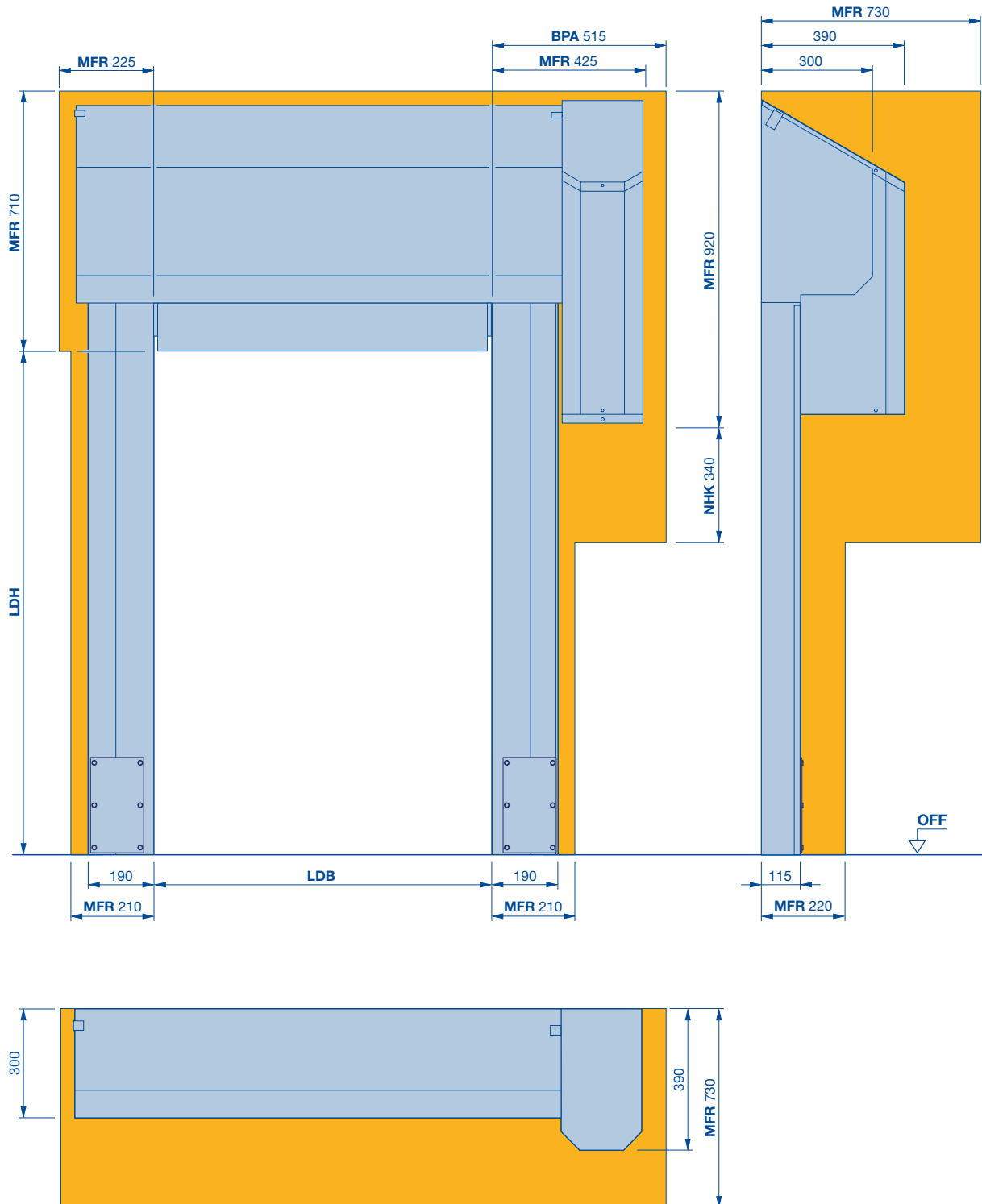

BPA Space required to fit and dismantle the operator
LDB Clear passage width
LDH Clear passage height

MFR Space for fitting the door
NHK Space requirement for emergency crank handle

High-speed doors for individual applications V 3009

Conveyor systems

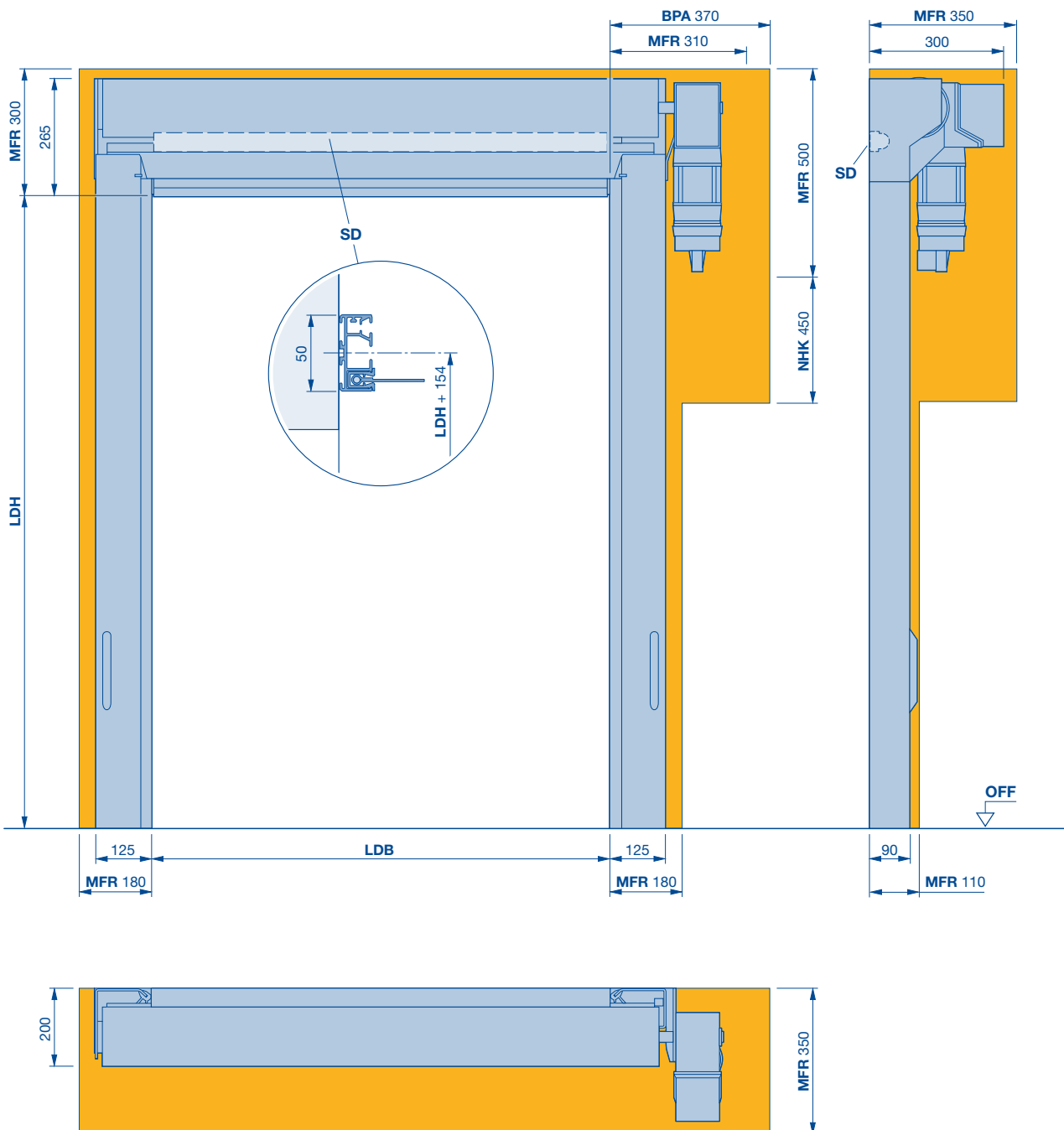

BPA Space required to fit and dismantle the operator
LDB Clear passage width
LDH Clear passage height

MFR Space for fitting the door
SD Lintel seal
NHK Space requirement for emergency crank handle

High-speed doors for individual applications V 3009

Conveyor systems

Full cladding, straight

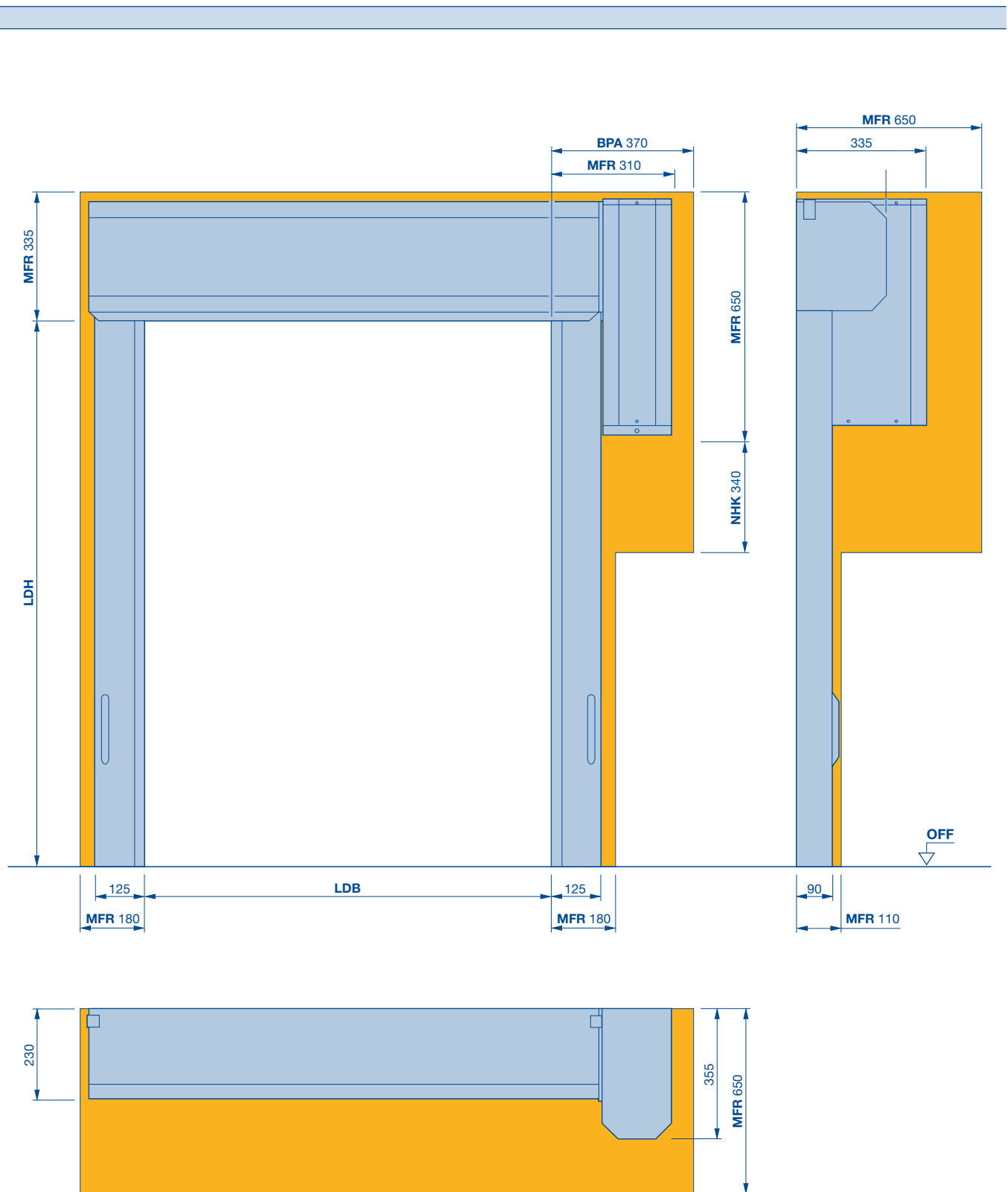

BPA Space required to fit and dismantle the operator

LDB Clear passage width

LDH Clear passage height

MFR Space for fitting the door

NHK Space requirement for emergency crank handle

High-speed doors for individual applications V 3009

Conveyor systems

Full cladding, chamfered

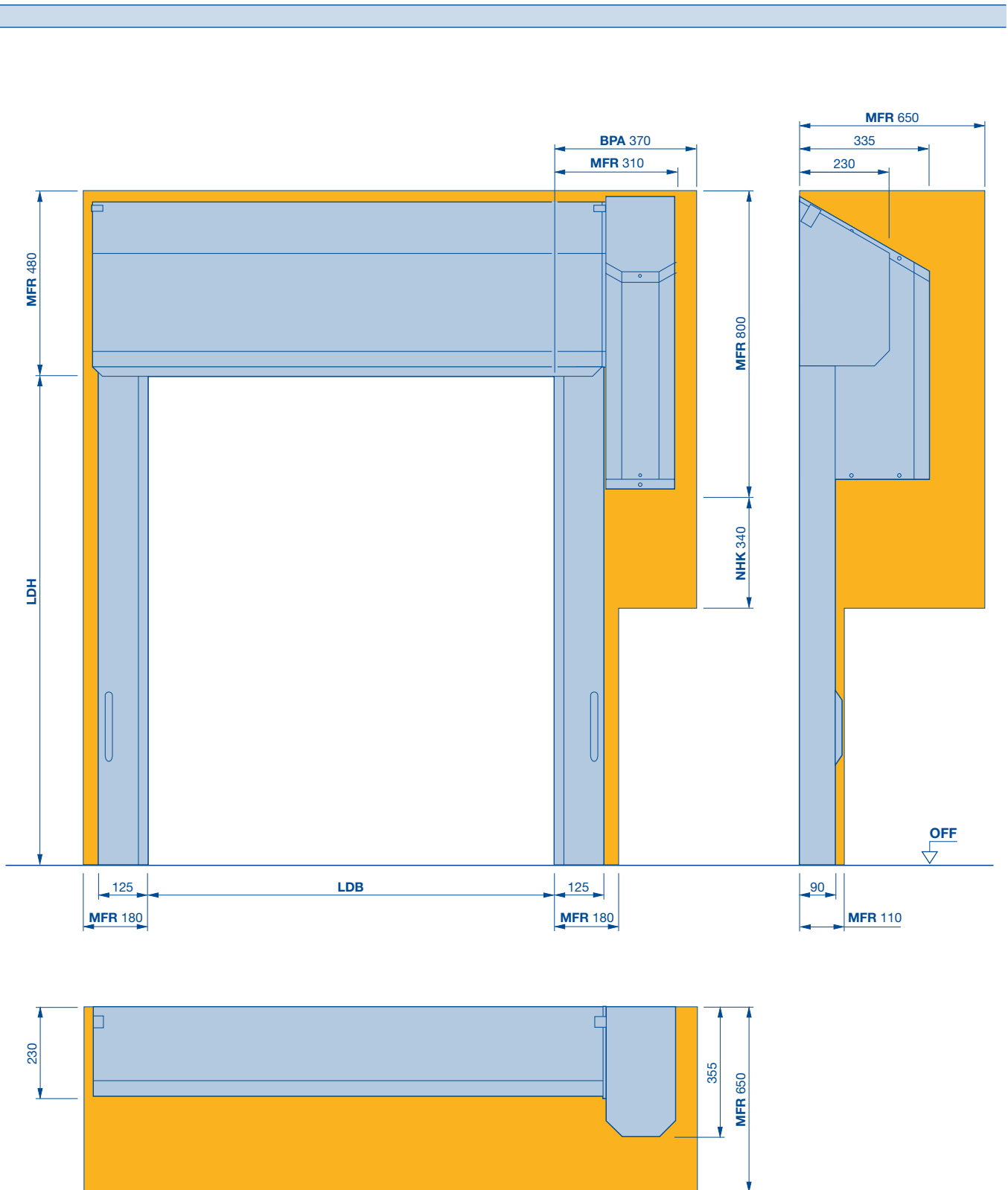

BPA Space required to fit and dismantle the operator
LDB Clear passage width
LDH Clear passage height

MFR Space for fitting the door
NHK Space requirement for emergency crank handle

High-speed doors for individual applications V 6030 Atex

Potentially explosive areas

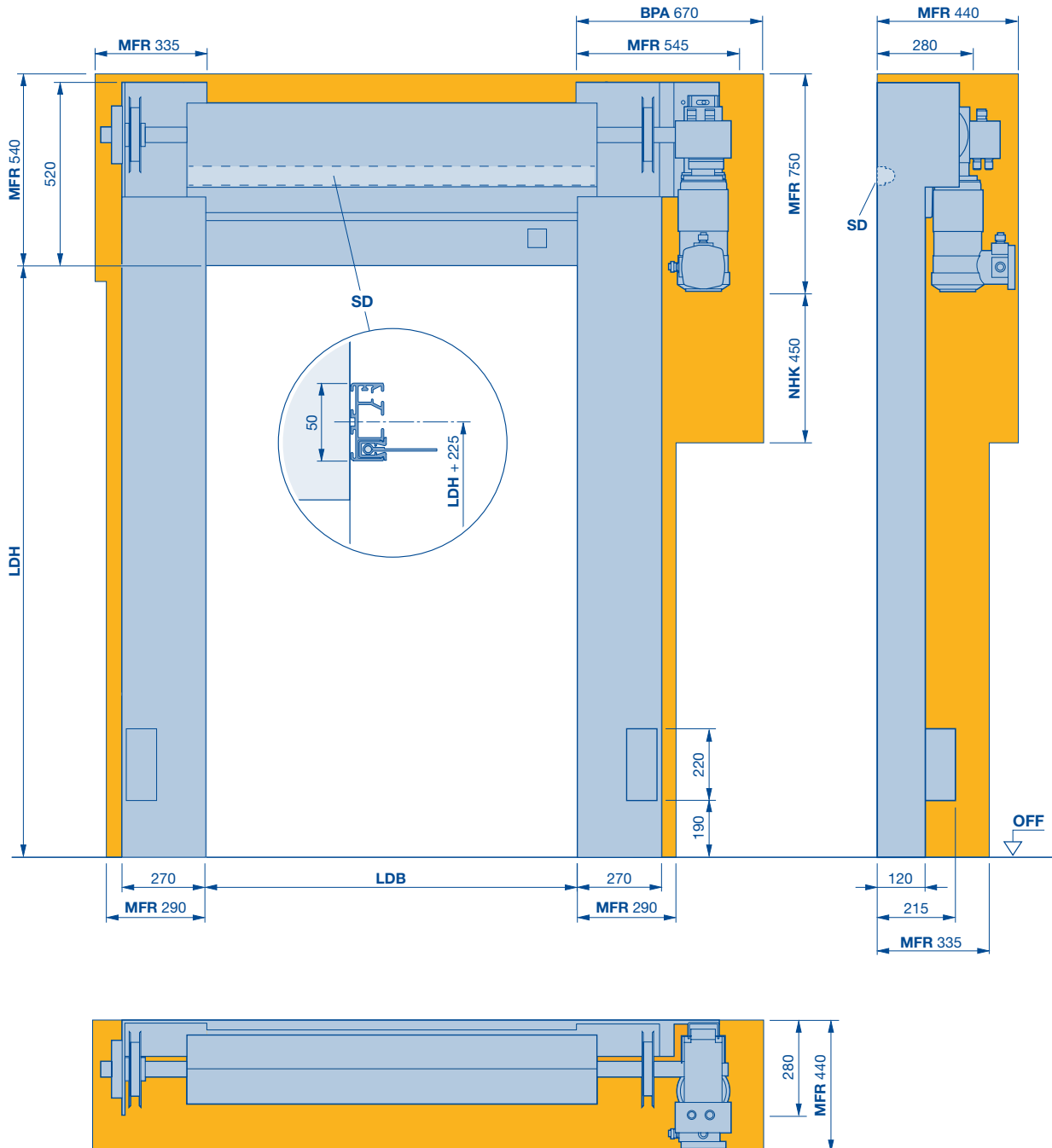

BPA Space required to fit and dismantle the operator
LDB Clear passage width
LDH Clear passage height

MFR Space for fitting the door
SD Lintel seal
NHK Space requirement for emergency crank handle

High-speed doors for individual applications V 6030 Atex

Potentially explosive areas

Full cladding, straight

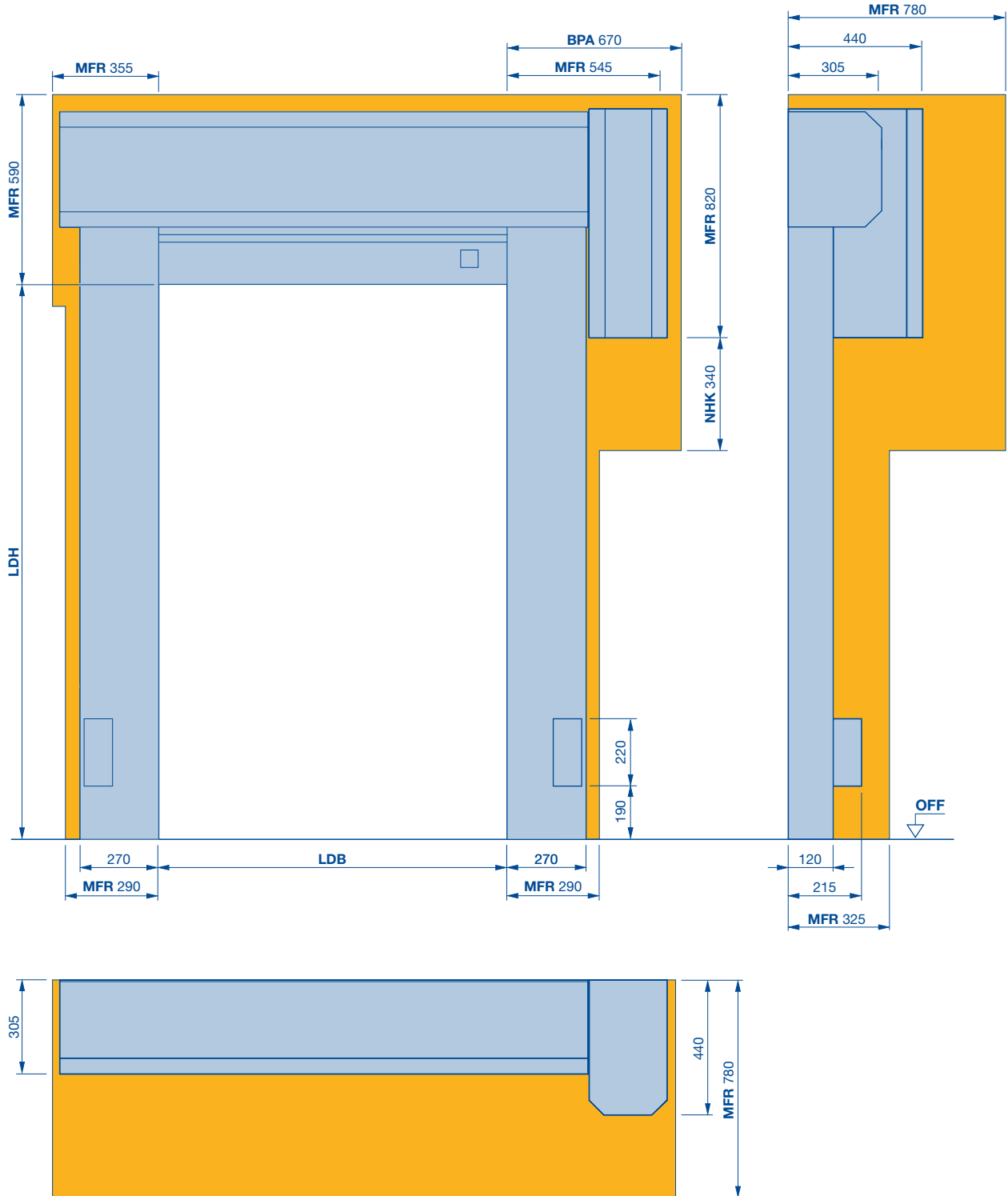

BPA Space required to fit and dismantle the operator
LDB Clear passage width
LDH Clear passage height

MFR Space for fitting the door
NHK Space requirement for emergency crank handle

Brand quality for residential and commercial construction

The family-owned company Hörmann offers all important construction components for building and renovating projects from a single source. We manufacture in highly-specialised factories using the latest production technologies. Furthermore, our employees work intensively on new products, continual further developments and improvements to details. The results are patents and one-of-a-kind products you can depend on.

