

safe · timeless · beautiful



markilux *inside – out*

The markilux Alfresco Concepts include:

- mistral
- awnings with lighting & heating
- syncra
- side screens
- parasols





markilux mistral



photo by courtesy of SCALA, Münster

An excellent addition to your restaurant or bar areas, to protect your customers from the elements.

The system is easily fitted and is available in size 400 x 400 cm. Additional units can be linked together to cover larger areas.

The frame system is made of extruded aluminium, with built-in gutters and drainage system.

The awnings can be operated individually giving you flexibility to create the coverage needed.

Accessories

The Mistral is available with:

- Light unit
- Heater unit including lights
- Heater unit with an illuminated central advertising box

supplied with



optional accessories



Infoline



Hotspot

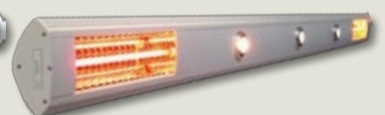

Spotline



Gutters





markilux 8000

The photograph opposite shows how the markilux 8000 is the ideal solution to your outdoor seating requirements, offering overhead protection for your customers.

It can also be used in conjunction with the markilux RS-8000 frame, thus providing a functional extension to your premises.



awning fabrics, available in acrylic and sunsilk

- light and colour fast according to ISO 105/B 02
- weather resistant according to ISO 105/B 04
- tear proof
- resistant to all environmental influences
- insensitive to heat and cold
- with a water-repellent coating
- quick drying
- easily cared for

markilux Design and Materials

Markilux awnings are as beautiful as they are strong. Featuring superior strength and durability, every markilux awning has drop-forged joint components made of aluminium or steel.

All cassette and front profiles, cover boards, roller supports and fixture brackets are made from the highest grade of extruded aluminium.

With a choice of almost 30 awning systems, more than 200 fabric colours and patterns and a broad variety of accessories a markilux awning will be tailored to your exact specifications.



markilux 8000

- robust self-supporting housing made of extruded aluminium
- covers at either end of the cassette simplify maintenance
- no re-adjustment necessary with Kevlar drive belts
- unit is pre-assembled making fixing considerably easier
- the motor has electronic limit switching and a torque cut-out mechanism so it switches itself off automatically if the awning encounters an obstruction
- the extremely sturdy front profile is made of extruded aluminium to minimise deflection in the front profile and sagging in the cover





markilux awnings & accessories

Markilux offers you different solutions in motorised cassette style awnings. We provide the perfect answer for restaurants, cafes and bars who require overhead protection for their dining areas



markilux spot lights

With the new markilux spots you can direct light where you want it – whether it is to create an inviting and pleasant environment outside a cafe or illumination of goods in front of a store.



markilux heater

For a warm and cosy atmosphere.
The markilux heater covers an area of 9-12 m².

markilux new Hotcap

Free standing heater, the ideal mobile option for all your outside seating areas. This can be permanently fixed or moved to any location where heat is required.

The Hotcap has two heaters, which can be switched on and off independently of each other.

Encouraging your customers to stay longer and enjoy their evening in a warm environment.



markilux al fresco protection

An alternative solution for your outdoor seating areas, a combination of awnings and side screens can be used as shown.

This option enables you to retract the awning and side screens, especially if you need to clear your pavement area at the end of the day.

This will give you extra flexibility without a permanent fixture.

markilux retractable side screen

The retractable side screen is an easy way to protect your customers in any outside seating area from the elements.

A convenient and cost-effective side screen and the **NEW** markilux mobilfix+, a moveable floor stand on wheels which if required can be used in conjunction with or without Shadeplus guide.

Also available with standard floor fixtures.

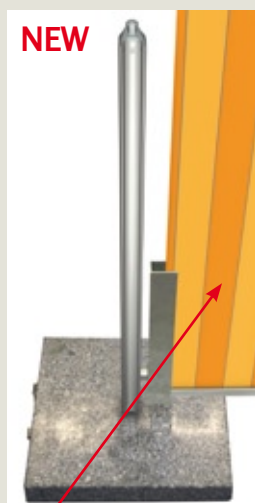

markilux shadeplus

The shadeplus is the ideal additional shading to your awning. This extra length of fabric extends from the front profile of the awning, to give your customers extra shade when necessary.

The shadeplus is also available in markilux transolair, which allows your customers to see through the fabric when extended.

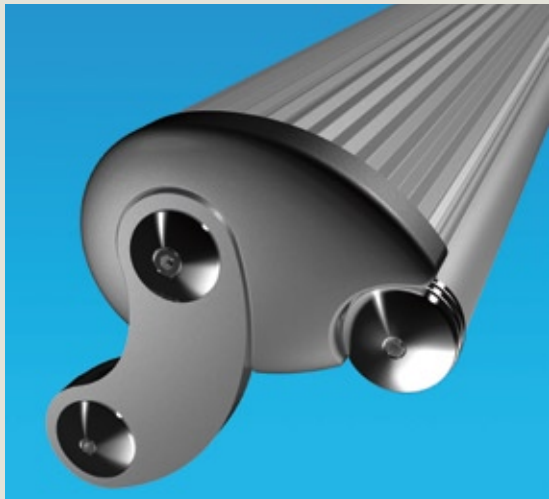

markilux ES - 1 & ES - X

When the markilux ES-1 came onto the market, it was greeted with astonishment. An awning made completely from stainless steel? It was unique, and remains so to this day. After all, the markilux ES-1 is more than just an awning: it is truly incomparable, a masterpiece and one of today's design classics, catering for the highest demands in terms of materials and appearance.

The stainless steel awning series from markilux offers you two designer awning options in the markilux ES-X and the ES-1, where beauty and elegance are combined in complete harmony. Engineered to complement modern and classical architecture perfectly. Clear lines and the finest materials provide your shaded area with elegance and the feeling of open space - an oasis of peace and tranquility.

While the markilux ES-1 relies on gas piston arms, the markilux ES-X merges its exquisite design with the new bionic tendon.



supplied with

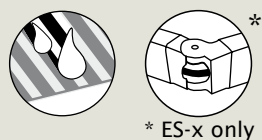

optional accessories

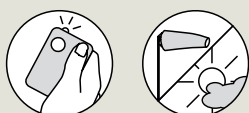



markilux 6000

Three creative styles each with their own colour and design options make it easy for you to create the perfect Markilux awning. Regardless if you choose Club, Studio or Lounge to create a classical or refined look – every style adds its own individual accent. Each option is of the highest quality and makes use of innovative technology, **not yet available with any other awning.**

The revolutionary bionic tendon, exclusive to markilux, has a 10 year warranty and is able to endure more than 10,000 Newton tensile force. This is equivalent to the weight of a compact car!

The combination of the Anthracite awning colour with stylish end caps in black or polished chrome, inserts in wood effect or stainless steel mesh creates an innovative and refined look perfectly suited to the customer who requires something different.

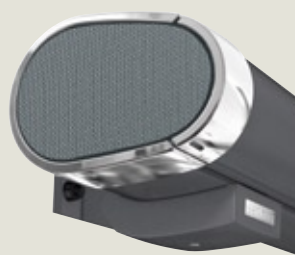

Insert colour

 Stainless steel mesh

Insert colour

 Wood effect

Endcap trim colour

 Polished chrome

Endcap trim colour

 Black chrome

Awning colour

 Nano anthracite metallic (DB 703/2 Nano)

Awning colour

 Nano anthracite metallic (DB 703/2 Nano)

supplied with



optional accessories



reddot design award
winner 2006



markilux syncra

Solve your space problems with a Syncra!

The markilux syncra is the complete solution for all your customers requirements, designed for outdoor use all year round.

The sturdy steel support structure holds a double awning. The frame can be set into concrete or bolted into the ground.

For the comfort of your customers we have optional accessories:

- Heating
- Exterior lighting
- Draught-reducing side screens



supplied with



optional accessories





markilux screens

A practical solution to your al fresco areas on a temporary, semi-permanent or permanent basis.

A versatile and stylish way to define outside spaces on virtually any terrain, markilux screens are simply erected with interlockable sections to enable you to increase the size of your seating area.

Branding

markilux screens are easily printed with your choice of company logos, in a wide selection of colours.



Fabric

Screens are made from durable fabric in a variety of colours.

Frame

The frame is made of aluminium and is powder-coated in white RAL 9010 (standard) or silver metallic RAL 9006

Floor fixing options

Steel plates or steel bases



markilux parasols

The stunning award-winning sunburst shade, with innovative design and unique shape, cannot fail to make an impression. The markilux sunburst can be illuminated from the inside, creating a wonderful atmosphere either inside or out.

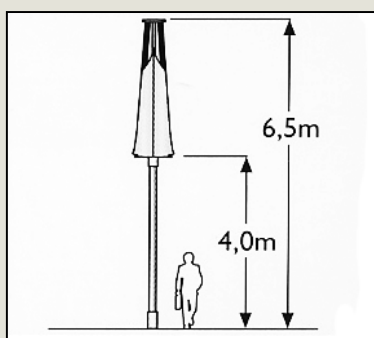
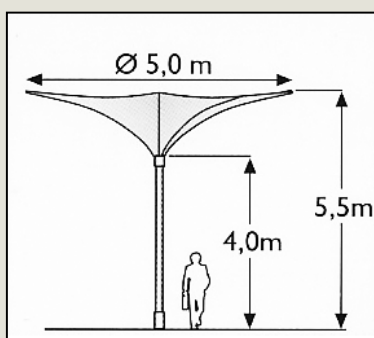

markilux sunburst



Branding

State of the art printing techniques and lighting systems allow your advertising message to shine through, both day and night!

The diameter of 5 metres, with a 20 metre printable surface available, is guaranteed to get your product name noticed.



markilux cassa-blanca

The telescopic umbrella is one of the most important in the markilux range of parasols.

Because it is constructed with solid aluminium, diameters of up to 14 metres are possible. The larger models are equipped with an electric drive instead of the manual crank.

Heating and lighting can be fitted to the parasol at a later date to maximise use of your outside areas in all seasons, day and night.



markilux linked cassa-blanca

Several telescopic umbrellas can be grouped together as shown or, using rain drain membranes, can even form continuous outdoor coverage!

In contrast to permanent roofing, this provides guests not only with shielding from sun and rain,

but also guarantees maximum enjoyment of outside serviced areas throughout the seasons.

These options make the markilux cassa-blanca the most popular style for commercial use.



markilux bar lounge

This product is ideal for outside catering, with collapsible window screens, creating an outdoor hospitality area which will increase your turnover. The bar lounge can be customised to your own specifications with soft furnishings, floor coverings, bar fittings and furniture.

The wind resistant screen with door panels can be designed in various ways, either partially or fully glazed with bespoke branding to the lower half if required.

Available sizes 7 x 7m or 4 x 4m. The aluminium frame is easy to assemble and dismantle.

safe · timeless · beautiful



Please contact:

Samson Awnings and Terrace Covers
6/8 Meadow Close
Finedon Road
Wellingborough
Northamptonshire

(0800) 328 6250

enquiries@samsonawnings.co.uk