

Light is life

Your new transparent garden space

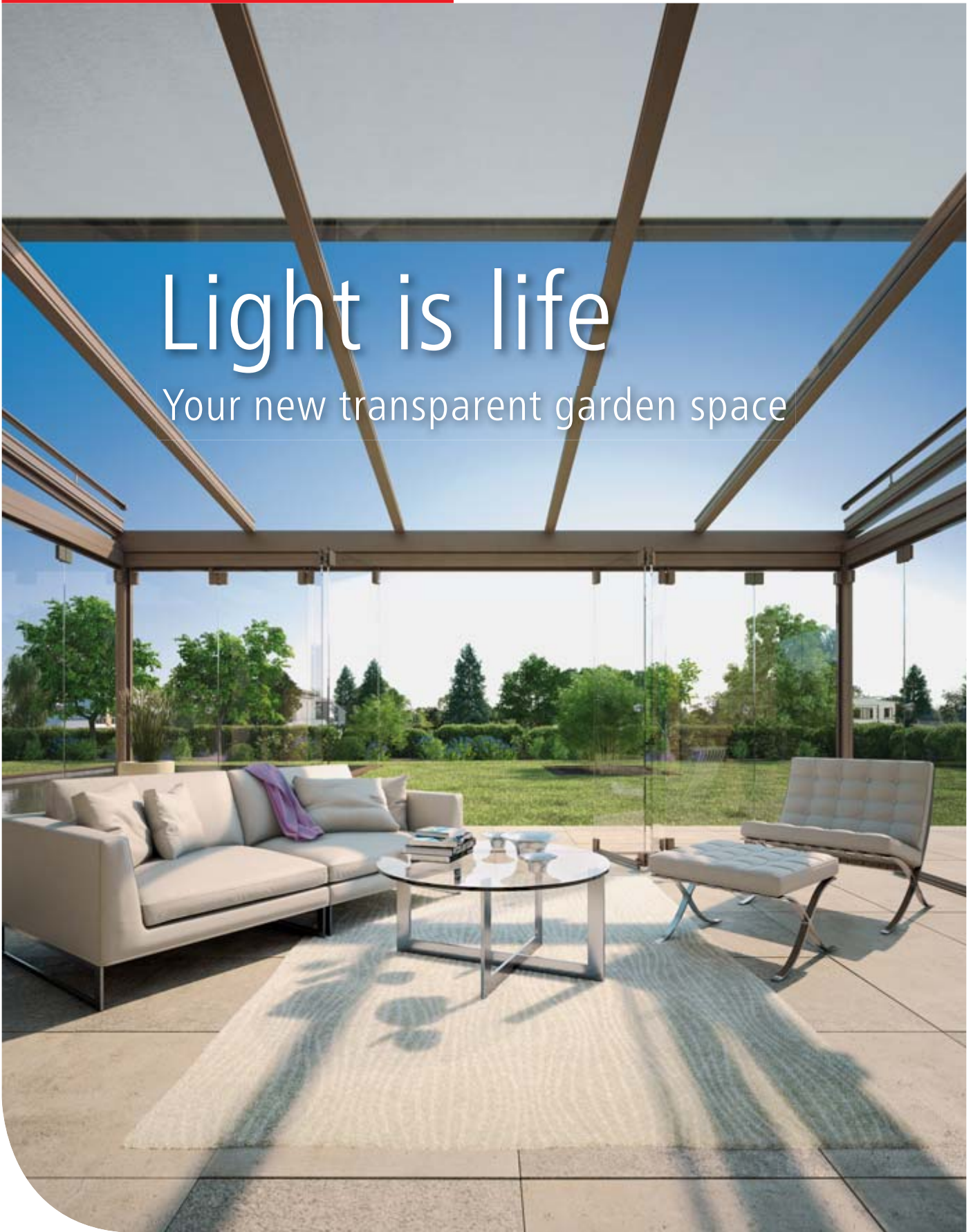

weiner Terrazza patio roof system



Terrazza patio roof – enjoy life al fresco



Enjoy your garden until well into autumn – weinor's Terrazza patio roof will keep you well sheltered from the wind and other elements. And your patio furniture can remain outside without being damaged. The appeal of weinor's patio roof is its elegant construction, attractively shaped design and high durability. With numerous versions available, it is also very suited to many different types of houses and requirements.



Masterfully adaptable – the right patio roof to meet your needs

weinor patio roofs not only stand out for their very elegant design and seamless look. With so many versions to choose from, they also adapt effortlessly to complex building situations.

Three roof models – equipped exactly the way you need them

To ensure that your patio roof is a perfect match for your house, feel free to choose from a number of different roof types (see p. 11). Three Terrazza models are available:



Patio roof without overhang, with integrated guttering

The basic model comes in a classic conservatory design: if you don't need an additional roof overhang, you will find the Terrazza pent roof a good solution.



Patio roof with roof overhang and pre-fitted guttering

The protruding roof on the slender Terrazza E version blocks out rain falling at an angle.



Patio roof with roof overhang and integrated guttering

Or opt for a Terrazza Plus with roof overhang and integrated downspout – to make sure the rain drains off as it should.



Sturdy aluminium construction – safety-tested in every way

weinor patio roofs stand out for their exceptional stability and durability. These durable constructions are based on static calculations run by a certified engineering company.

- sturdy roof supports in a variety of configurations

- extra-thick walls in a slim structure
- steel inserts optionally available, also as guttering reinforcements if required
- corrosion-proof thanks to aluminium profiles and stainless steel screws
- snow-bearing load up to 550 kg
- roof depths up to 6 m



Wall mounting

LED/Design light bar – bask in the evening atmosphere on your patio

Our light bar extends the amount of time you can use your patio roof until well into the evening. The light bars can be wall-mounted or fitted to a roof support depending on your preference.

- warm, atmospheric light thanks to special glass lenses
- highly energy efficient
- operating life of 30,000 hours
- radio-controlled dimmer using BiConnect
- light bar housing in same colour as patio roof
- patent pending LED spotlights



reddot design award
winner 2009

weinor Glasoase®

**Flooded with light and heaped
with honours**

The weinor Glasoase® received the 2009 red dot design award for high design quality. Rely on the safety of an internationally acclaimed brand!



The weinor Glasoase® – light-filled elegance



Bring your garden into your house – smooth transition to the outside provided to you by the elegant weinor Glasoase®. This glass oasis is a combination of a Terrazza patio roof comprising all-glass elements that can be closed to form an uninsulated conservatory. With so many flexible and fixed-glazed side elements to choose from, there are combinations galore. To see our roof shapes, please go to p. 15.



The easy-glide sliding door – the effortless all-glass system

It doesn't get any easier than this: thanks to its premium-quality fittings, weinor's easy-glide sliding door is a breeze to operate and also locks if required.



Easy to open – convenient and user-friendly

The easy-glide sliding door is outstandingly easy to operate.

- very user-friendly all-glass elements

- sliding the panels is a breeze
- exceptionally smooth operation
- foot-operated lock on the inside – no need to bend over



Actuator function – all the panels can glide at the same time

The intelligent actuator function makes for very fast operation of the all-glass elements.

- slide multiple panels in one go
- close entire fronts with a flick of the wrist



Retrofittable – for virtually every patio roof

Being a floor-mounted structure, weinor's easy-glide sliding door fits under virtually every patio roof as well as numerous roof structures.

- weinor Terrazza can be added to create a Glasoase®
- no additional costs for structural safety adjustments
- matching profiles from weinor for easy retrofitting



Roof shapes in abundance – and just the way you need them

weinor patio roofs and Glasoasen® blend in to the shape and look of your house – even on protruding walls and corner solutions. Your weinor retailer/partner will gladly advise you on the right roof shape to suit your needs.

Contact your weinor retailer/partner for advice!

Most roof models and types can be readily combined with weinor glazing elements: we will gladly provide you with details of other customised shapes on request (not all vertical glazing elements and versions are available with special shapes, however).

Roof models (see p. 5)



Terrazza model

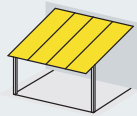

Terrazza E model
with roof overhang and
pre-fitted guttering

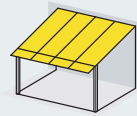

Terrazza Plus model
with roof overhang and
integrated guttering

Roof types for Terrazza patio roof and Glasoase® (see p. 5 + 7)



Pent roof –
Type A



Sloping pent
roof – Type B

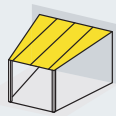

Trapezium-shaped
roof sloping
to eaves – Type C



Trapezium-shaped
roof sloping
to ridge – Type C

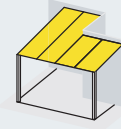

Pent roof
with wall offset

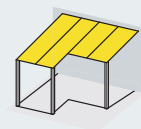

Pent roof
with roof
guttering offset

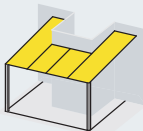

Pent roof
with balcony
cutout

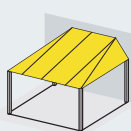

Hipped
pent roof



Pent roof,
hipped and
sloping forwards

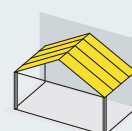

Gable roof –
Type L

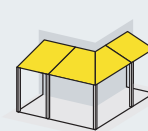

Circumferential
pent roof –
Type N



WeiTop carport

Matching side glazing – tailored to your needs and wishes

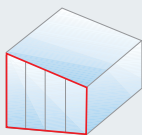

Maximum transparency: SUPER LITE side element

Adding fixed glazing below the Terrazza side roof support opens up the possibility to include fully-transparent front panels – with not a single vertical or horizontal strut in sight.

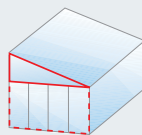

Complements the folding partition and sliding wall: LITE side element

Lightweight fixed glazing at the top of the trapezium, with a weinor easy-glide sliding wall below, or a multi-function folding partition – if you go this way, you'll be choosing a very popular combination!

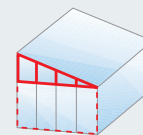

As stable as they come: CLASSIC side element

Or go for sturdy fixed glazing at the top of the trapezium, with a multi-function sliding wall below – or even framed fixed glazing to hold off strong side winds if you prefer.

Multi-utility slide-and-turn partition w26-c



Multi-utility slide and turn glass partition – all glass elements for balconies and loggias

weinor has many suitable solutions for anyone wishing to use their balcony whatever the weather. The multi-utility slide and turn partition is the ideal solution for balconies and loggias.



Elegant door handle
of stainless steel

Simply slide open and swing neatly out of the way

The multi-utility slide and turn partition runs on only one narrow guide rail and therefore is suitable for the majority of existing balcony balustrades.

The glass panes are simply pushed to the side or round the corner and turned into the parking position to save space.



Slide them round the corner – and open up the entire front

The glass panes of the multi-utility slide and turn partition can be completely guided round

the corners. Opening direction to the right, to the left or in both directions, as you wish.



Retrofittable – ideal for existing balconies and loggias

The multi-utility slide and turn partition is a so-called "hanging system" and therefore does not put any stress on the balcony

balustrade. Especially suitable for retrofitting existing balconies and loggias.



Ideal balcony glazing – for a fantastic open air feeling

With the multi-utility slide and turn partition, the panes are guided to the wall and turned into the parking position. The glass front is opened completely, for the perfect open-air feeling.

What's more, the outside panes can easily be reached in this position, making them easy to clean.





Three perfect sun shades and blinds for Terrazza, Glasoase® and conservatories



With the right form of sun protection for your patio roof, Glasoase® or conservatory, the fabric will shelter you from the heat, glare and prying eyes – and also make you feel even more at home. For well-ventilated patio roofs and Glasoasen®, often the only anti-glare protection that you need is an undermounted conservatory awning. A conservatory can quickly become very warm when the sun shines in. This is where a roof-mounted conservatory awning can help provide a pleasant indoor environment. Vertical protection from the sun and prying eyes comes in the shape of our red dot award-winning VertiTEx vertical awning.



WGM 1030/2030 Design – roof mounted awnings that stand the test of time

weinor's roof-mounted WGM 1030 and 2030 Design conservatory awnings guard against overheating and therefore help create a pleasant climate. As they are robustly constructed, these awnings can remain open up to wind force 6 despite their large fabric surface. Can be retrofitted to virtually any roof type.



Clever tensioning system – taut fabric and wind stability

The ingeniously designed block and tackle incorporated into the tensioning system, plus a fast-reacting tension spring, ensure the fabric is taut at all times.

- tear-resistant and high-tensile Tex-Seil rope as used in ocean sailing
- patented rope winding – controlled and near-noiseless

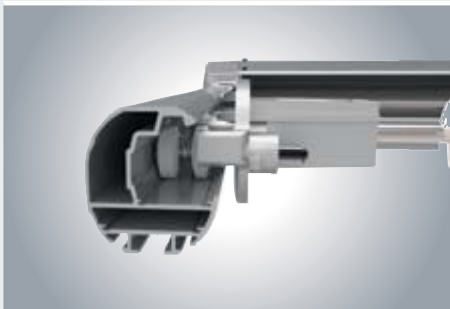

weinor carriage system – precise and low-noise

The appeal of weinor's tried-and-tested carriage, with its precision rollers, is that it runs very quietly.

- smooth, low-noise opening and closing

- precise running and exact winding of the textile rope in the carriage
- loose-fitting bearing on carriage prevents it from jamming in side winds



Coupled multi-panel systems – for large dimensions

Large areas can be shaded using a multi-section unit. The coupling system makes sure fabrics open to the exact same position every time, even on large units.

- simultaneous opening and closing for harmonious appearance
- WGM 2030 opens to any desired length
- two-section units can be operated with one or two motors



Fabrics – attractive, brilliant long-lasting colours

A high-quality fabric is the basis of a beautiful awning. The colours by weinor® collection and the Perluca climate-control fabrics provide a wide range.

- solution-dyed to make them colour-fast
- lastingly beautiful thanks to dirt- and water-repellant nanocoating
- optional: wide range of collections by other manufacturers



Fabric collections
155 patterns

- high-quality acrylic
 - proven for decades
 - unit width: 120 cm/240 cm
- innovative polyester quality
 - unit width: 120 cm



High-tech climate-control fabrics
10 patterns

- translucent, breathable climate-control fabric
- unit width: 177 cm (Soltis® 86, 92)
- extra-wide: 267 cm (Soltis® 86, 92, 93)



weiner Sottezza/LED – undermounted awnings with a homelike feel

The undermounted Sottezza conservatory awning is an attractive anti-glare screen that is always a good choice below a Glasoase® or patio roof because it provides for ample air circulation. The customisable sizes also make it a good fit for any other rectangular patio roof.



Attractive design – slim and smart

This attractive, round cassette discreetly blends into the architecture of the patio roof. The cassette's round shape also leaves space for weinor's optionally available LED light bar.

- little cassette overhang for maximum use of space
- slim side channels leave narrow gap in fabric (only about 40 mm)
- no screws visible



Innovative tensioning system keeps fabric position well adjusted

The regular billows of fabric create a cosy atmosphere. This is all thanks to the simple, resilient tensioning system.

- fabric constantly kept uniformly taut using gas springs, automatically tightened into final position
- Tex-Seil rope using ocean sailing technology; quiet-running, tear-resistant, high tensile strength



Sottezza LED – pleasant light into the evening hours

The Sottezza LED creates atmospheric lighting under your patio roof. The light bar matches the colour of the Sottezza.

- 30,000 hours of lighting with minimal energy consumption
- highly energy efficient
- infinitely dimmable using BiConnect
- patent pending LED spotlights



Fabrics – attractive, brilliant long-lasting colours

A high-quality fabric is the basis of a beautiful awning. The colours by weinor® collections provide a wide range.

- solution-dyed to stay colour-fast
- lastingly beautiful thanks to dirt- and water-repellant nanocoating
- optional: wide range of collections by other manufacturers



Acrylic fabrics
100 patterns

- high-quality acrylic
- proven for decades
- unit width: 120 cm/240 cm



Polyester fabrics
55 patterns

- innovative polyester quality
- high-stretch with memory effect®
- unit width: 120 cm



reddot design award
winner 2008



VertiTex window shades – maximum unit widths in an ultra-slim cassette

With an exterior vertical shade from our red dot award-winning VertiTex, you have an anti-glare screen, wind protection and privacy screen all rolled into one. The patented OptiFlow-System® allows us to use a very small and slim cassette on the VertiTex – yet it is still big enough to house large awning fabrics.



VertiTEx WeiTop – ideal for patio roofs, Glasoase® or conservatories

The shape of the VertiTEx housing makes it an ideal match for the guttering on a Terrazza patio roof and a Glasoase®.

This allows it to blend in perfectly into the overall design.



VertiTEx versions – also for windows and balconies

Thanks to their various installation possibilities, the VertiTEx rope or guide versions are also suited to shading windows or balconies. The dainty housing forms a harmonious whole with the window.

The VertiTEx Zip runs securely along side guide rails. This ensures that the fabric rolls out quietly and makes the vertical awning very resistant to winds up to force 8.



BiConnect

Convenient radio control – with the new BiConnect technology

weinor's new radio remote control BiConnect is a comfortable and convenient way to operate patio products. When combined with the BiSens weather sensors, it opens and retracts the vertical awning, for example, whenever and however you like.

- ultra-secure signal through routing function
- motor with integrated remote receiver on request
- even for houses with metal facades and thick insulation
- optional control via BiEasy app



Fabrics – attractive, brilliant long-lasting colours

A high-quality fabric is the basis of a beautiful awning. The colours by weinor® collection and the Perluca climate-control fabrics provide a wide range.

- solution-dyed to make them colour-fast
- lastingly beautiful thanks to dirt- and water-repellant nanocoating



Fabric collections
155 patterns

- high-quality acrylic
 - proven for decades
 - unit width: 120 cm/240 cm
- innovative polyester quality
 - high-stretch with memory effect®
 - unit width: 120 cm



Air-permeable acrylic
fabrics, 5 patterns

- perforated acrylic
- translucent, breathable climate-control fabric
- unit width: 120 cm/240 cm



High-tech climate-control fabrics
10 patterns

- translucent, breathable climate-control fabric
- unit width: 177 cm (Soltis® 86, 92)
- extra-wide: 267 cm (Soltis® 86, 92, 93)



BiConnect

Simply intuitive.

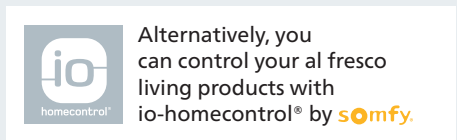
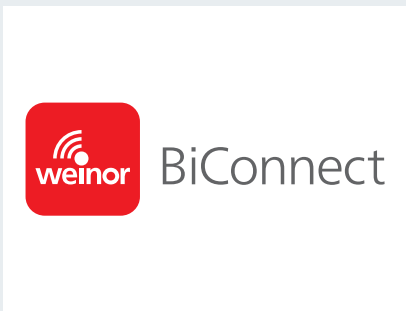

Convenient radio control – with the new BiConnect technology

weinor's new radio remote control BiConnect is a comfortable and convenient way to operate patio products. When combined with the BiSens weather sensors, it opens and retracts awnings, for example, whenever and however you like.

- ultra-secure signal through routing function
- even for houses with metal facades and thick insulation
- optional control via BiEasy app

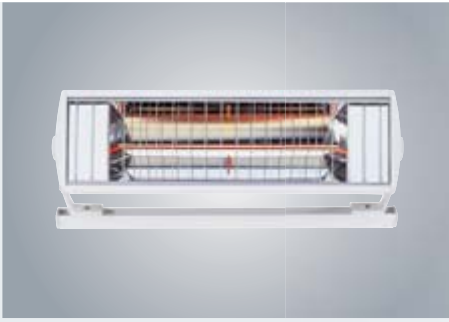

Tempura heating system – cosy warmth on cooler days

Pleasant, instant heat without any pre-heating: the energy-efficient Tempura infrared heater delivers a heat output of over 1,500 watts. Very easy to operate and control using the BiConnect radio controls.



LED/Design light bar – patio enjoyment into the evening hours

Light bars can significantly extend the time you can use your patio.

- atmospheric light thanks to special glass lenses
- highly energy efficient
- operating life of 30,000 hours
- radio-controlled dimmer using BiConnect

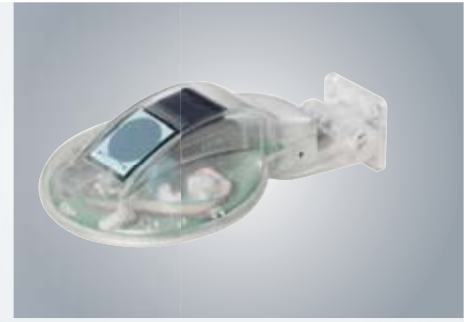

Weather sensors – automatically react to wind and weather

They open your awning automatically when the sun comes out and can optionally retract it in the wind and rain:

- sun sensor
- sun and wind sensor (solar-powered version also available)
- sun, wind and rain sensor



Roof vents for a breath of fresh air

The WeiTop DL permanent roof vent provides a healthy climate and reliable ventilation.

- ingenious design using overlapping roof covers
- spent air is constantly led outside
- insect guard optionally available
- optional winter screen can be readily attached for thermal protection



Sliding skylights: ventilation at the push of a button

Lose the heat and spent air – the WeiTop DS sliding skylight adds a pleasant climate to your Glasoase®.

- readily retrofittable
- incl. motor for convenient automatic control
- easy to regulate using the hand transmitter
- opens as wide as you want



Paravento – side privacy screen at a flick of the wrist

Added privacy comes in the shape of a pull-out side screen: the Paravento provides the best-possible shelter from winds and prying eyes. You can also choose a fabric and colour to match your conservatory awning.

9 WiGa trend colours

Extensive selection – here's where the frame colour comes into play!

Our range of frame colours is so diverse that you will always find a shade that harmonises with the existing architecture: choose from more than 200 colours!

weinor provides a maximum degree of colour uniformity

As weinor does all the powder coating in its own workshop, you can also rest assured that different products come with the same top-class colour tonality and identical gloss level.

Choose from an abundance of high-quality colours:

- 47 standard RAL frame colours, silk gloss
- 9 scratchproof, resistant trend colours with an elegant textured look
- over 150 special RAL colours

weinor is an eco-friendly company. To ensure compliance with high environmental standards, manufacturing processes and materials undergo regular testing by experts.

As a result of the ban on the use of heavy metals in powder coatings, paint manufacturers can no longer guarantee colour stability despite making every effort to do so. It therefore cannot be excluded that colours in general, and Fire Red (RAL 3000) in particular, may fade with time. Colours may differ significantly due to the printing process.

WT 029/90147
Approx.
RAL 9007 metallic

WT 029/50704
Approx.
RAL 6009 metallic

WT 029/60740
Chestnut 04
metallic

WT 029/70786
Sparkling iron
effect

WT 029/71289
Approx.
RAL 7016

WT 029/80077
Approx.
DB 703 metallic

WT 029/80081
Iron glimmer
effect P 7

WT 029/90146
Approx.
RAL 9006 metallic

WT 029/10797
Approx.
RAL 9010

47 standard RAL colours

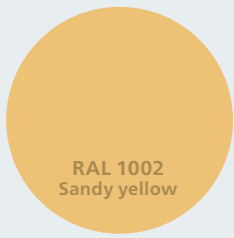

RAL 1002
Sandy yellow

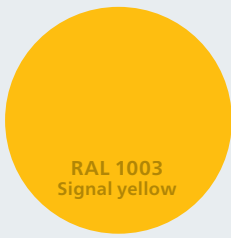

RAL 1003
Signal yellow



RAL 1014
Ivory



RAL 1015
Light ivory

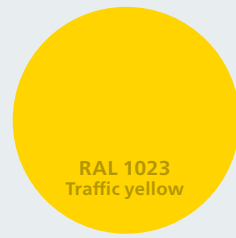

RAL 1023
Traffic yellow



RAL 1034
Pastel yellow



RAL 2000
Yellow orange



RAL 2002
Vermilion



RAL 2011
Deep orange

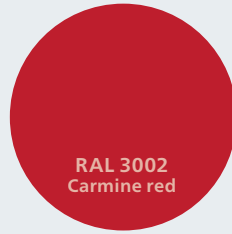

RAL 3002
Carmine red

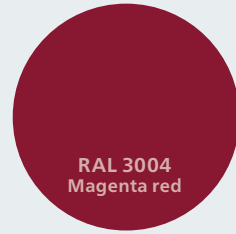

RAL 3004
Magenta red



RAL 3007
Black red



RAL 4005
Blue lilac



RAL 4006
Traffic purple

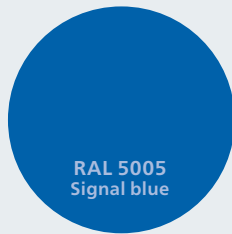

RAL 5005
Signal blue

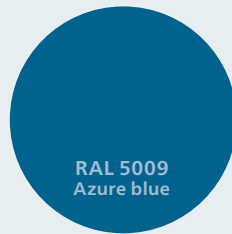

RAL 5009
Azure blue



RAL 5014
Pigeon blue



RAL 5021
Water blue



RAL 5022
Night blue



RAL 5024
Pastel blue



RAL 6005
Moss green



RAL 6009
Fir green



RAL 6011
Reseda green

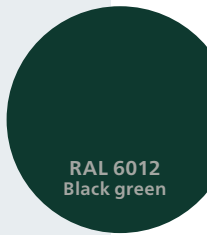

RAL 6012
Black green



RAL 7015
Slate grey



RAL 7016
Anthracite grey



RAL 7021
Black grey



RAL 7030
Stone grey



RAL 7032
Pebble grey



RAL 7035
Light grey



RAL 7039
Quartz grey



RAL 7040
Window grey



weinor 7319
weinor grey



RAL 8001
Ochre brown



RAL 8003
Clay brown



RAL 8014
Sepia brown



RAL 8016
Mahogany brown



RAL 8017
Chocolate brown



RAL 8019
Grey brown



RAL 8022
Black brown



Configure
online at
www.weinor.com



weinor 8077
weinor dark brown



RAL 9001
Cream

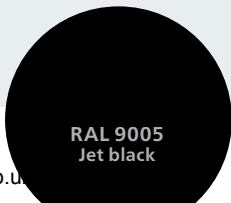

RAL 9005
Jet black



RAL 9006
White aluminium



RAL 9007
Grey aluminium



RAL 9010
Pure white

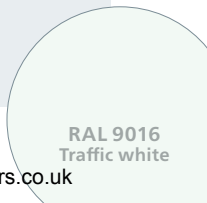

RAL 9016
Traffic white



reddot design award
winner 2008
weinor VertiTex



reddot design award
winner 2009
weinor Glasoase®



“Made in Germany” – award-winning technology and designs

For over half a century, we have pursued the same mission: customer satisfaction. As a medium-sized, international company, weinor’s quality is as good as it gets and “Made in Germany”. All our products are designed and manufactured in Germany.