



Up to
49%*
better
thermal insulation

Function Doors for Your Home

NEW: Multi-purpose door with thermal break MZ ThermoPlus





CONTENT

6	Good Reasons to Try Hörmann
10	Security Door KSI Thermo
12	Security Door KSI
14	Multi-Purpose Door MZ Thermo / MZ ThermoPlus
16	Multi-Purpose Door MZ
18	Fire-Rated Door H8-5
20	Multi-function door H3D
22	Fire-rated security door WAT
24	Internal Door ZK
27	Colours and Decor Surfaces
28	Steel Frames
30	Size Range
32	Door Sizing
35	Wall Connections
36	Timber Internal Doors
38	Programme Overview

The colours and surface finishes shown are subject to the limitations of the printing process and cannot be regarded as binding.

All rights reserved. No part may be reproduced without our prior permission. Subject to changes.

* Up to 49% better thermal insulation with the MZ ThermoPlus compared to a conventional multi-purpose door

Products on title page (from left): fire-rated door H8-5 in Grey white RAL 9002, external security door KSI Thermo in Anthracite RAL 7016, internal door ZK in Anthracite RAL 7016.

◀ **Multi-function door H3D** painted on site in Anthracite RAL 7016

The right door for every room – your comfort is guaranteed

Whether it is a new construction or modernisation, Hörmann offers the right door for every area of the house: security doors for basement or garage entrances, fire-retarding doors for the boiler room and multi-purpose doors for your hobby room – our high-quality steel doors make sure that you feel safe and at ease in your own home. Discover all the advantages and functions of our steel doors and individual design possibilities on the following pages.

The classification of the individual doors shows you at a glance which functions the respective door fulfils and to what extent – from highly suitable (★★★★★ / 5 stars) to unsuitable (no stars).





GOOD REASONS TO TRY HÖRMANN

“A good reputation must be earned.”

August Hörmann

In keeping with the tradition started by the company's founder, the name Hörmann delivers brand name quality with extensive product expertise. The family business has over 80 years of experience as a construction component specialist and sees itself as your partner from the very beginning of building and renovation projects. It's no surprise that Hörmann is one of Europe's most successful door providers. This makes a Hörmann door a reassuring purchase.



1 Quality products from Germany

All doors are developed and manufactured by Hörmann. Our highly qualified employees work intensively on new products, continual further developments and improvements to details. Patents and unique products on the market are the result of this. Endurance tests under real conditions ensure mature series products with Hörmann quality.



2 Doors for generations

We are convinced of our products and our uncompromising quality assurance. That is why you will enjoy a Hörmann function door in your house for many years.

3 An eye on the future

Hörmann is setting a good example. This is why the company has obtained over 70 % of its required energy from green sources and will continue to increase this percentage. At the same time, many tonnes of CO₂ are saved each year thanks to the introduction of an intelligent and certified energy management system. And last but not least, Hörmann offers products for sustainable construction. Find out more about Hörmann's environmental activities in the "We Think Green" brochure.

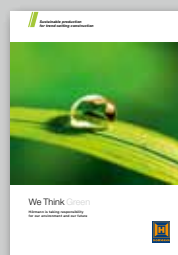

GOOD REASONS TO TRY HÖRMANN



4 Up to 49 % improved thermal insulation

You are looking for basement and side doors with the same thermal insulation as your entrance door? Then our security door KSI Thermo and multi-function doors MZ Thermo and MZ ThermoPlus are the right choice for you: the MZ ThermoPlus provides up to 49 % better thermal insulation than conventional multi-purpose doors.

Further information can be found on pages 10 / 11 or 14 / 15.

5 Break-in-resistant RC 2 security equipment

Security doors KSI / KSI Thermo and fire-rated security door WAT are available with approved, break-in-resistant RC 2 security equipment as standard. For you, this means: feeling even more secure in your own home. For multi-purpose door H3D, the equipment is optionally available as an additional function.



* Up to 49 % better thermal insulation with the MZ ThermoPlus compared to a conventional multi-purpose door

Our security doors' certified break-in resistance is also recommended by police information centres.



6 Individual designs

Design your door exactly the way you want it, to your own individual taste. You can choose between various colours and decors as well as glazings. Discover the design possibilities on pages 26 / 27.

7 Steel profile frame VarioFix

The innovative profile frame VarioFix is the ideal solution for residential constructions: The familiar timber frame fitting principle is now available for steel frames for the first time with VarioFix. Furthermore, the frame will also convince you with regard to design and robustness. Additional information about our frame types can be found on pages 28 / 29.

SECURITY DOOR

KSI Thermo

High security and the best thermal insulation



The KSI Thermo security door offers many advantages: thanks to a door leaf with thermal break, it offers the best thermal insulation and also comes with break-in-resistant RC 2 security equipment. We recommend using this quality door as an external door for basements, outbuildings and garages.



Product characteristics

Break-in resistance
★ ★ ★ ★ ★
Thermal insulation
★ ★ ★ ★ ★
Acoustic insulation
★ ★
Fire-retarding
Stress
★ ★ ★ ★ ★
Deformation resistance
★ ★ ★ ★ ★

External door for

- Basements
- Heated outbuildings
- Garages with direct access to the home

Ready-to-fit door set

Door leaf and frame with thermal break, galvanized and painted in Traffic white (similar to RAL 9016).

Single-leaf

Break-in-resistant, RC 2

acc. to DIN EN 1627 on opposite hinge side

Thermally insulated

$U_D = 1.1 \text{ W}/(\text{m}^2\cdot\text{K})$



Colours and decor surfaces

Page 27

Size range

Page 30

The same thermal insulation as with entrance doors

These days, saving energy is important throughout the entire home. The security door KSI Thermo provides excellent thermal insulation as the door leaf filled with PU rigid foam, frame and threshold all come with a thermal break. The door also features double seals on all four sides. With all of this, the KSI Thermo has a thermal insulation value usually only found in entrance doors.

Security as standard

Basement and side doors are often weak spots when it comes to security. In this respect, the KSI Thermo offers the best equipment as well: 2 conical swing bolts and 2 additional security bolts and 1 lock bolt engage in the frame's lock plate and firmly pull the door shut. 3 further security bolts and 3 guide rollers on the hinge side make it practically impossible to force the door open.



The security door KSI Thermo features a 46 mm-thick door leaf and a very good thermal insulation value of up to 1.1 W/(m²·K).

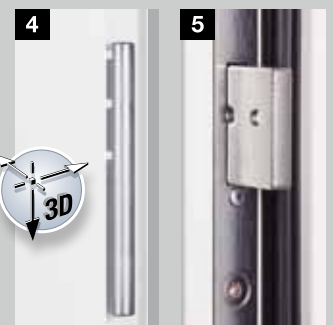

Three-way adjustable guide rollers for easy door function

Lock bolt for standard security

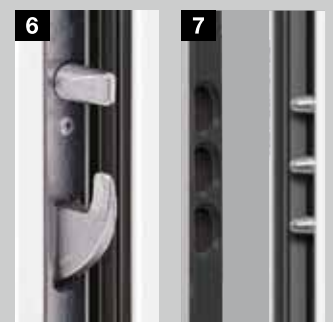

Swing bolt with security bolts

Security bolts on the hinge side

* Up to 30 % better thermal insulation compared to a conventional security door

SECURITY DOOR

KSI

The proven classic for more security



Basement entrances, outbuildings and garages are often equipped with old doors that can be forced open in seconds. Always remember: if the basement door is open, the whole house is accessible. This is why we recommend the KSI security door with standard security equipment for these areas.



Product characteristics

Break-in resistance

★★★★★

Thermal insulation

★★★

Acoustic insulation

★★

Fire-retarding

Stress

★★★★★

Deformation resistance

★★★★★

External door for

- Basements
- Unheated outbuildings
- Free-standing garages

Ready-to-fit door set

Door leaf and frame, galvanized and with powder-coated primer in Traffic white (similar to RAL 9016).

Single-leaf

Break-in-resistant, RC 2

acc. to DIN EN 1627 on hinge side and opposite hinge side

Thermally insulated

$U_D = 1.7 \text{ W}/(\text{m}^2 \cdot \text{K})$

Acoustic-rated

with optional retractable bottom seal
Rw approx. 32 dB

Climatic class III

acc. to RAL-RG 426

Duty category S

acc. to RAL-RG 426



Colours and
decor surfaces

Page 27

Size range

Page 30

Stable door leaf

The KSI features a double-skinned, 40-mm-thick door leaf with 3-sided thick rebate and sheet steel on both sides (0.8 mm). The stability of the door leaf is a result of the all-round reinforcement frame and the mineral wool insert which is glued over the entire surface. A 3-sided EPDM seal and double lip seal (incl. aluminium semicircular threshold at the bottom) seal the door reliably. This means you can always rely on the door in terms of function and tightness. Hörmann offers this door as a complete set with frame.

High security

The standard security of the KSI lets you and your family sleep peacefully, as it comes with pull-off protection and a drill-resistant security lever / knob handle set. The solid steel bolts on the hinge side make it almost impossible to force the door open. The KSI has been tested in accordance with European standard DIN EN 1627 on the hinge and opposite hinge side and has resistance class 2.



1.5-mm-thick corner frame with all-round seal

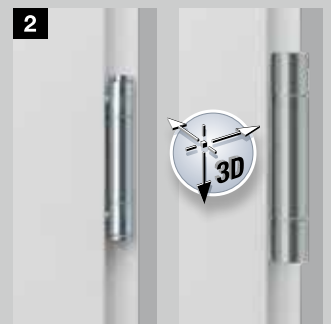

3-piece hinge (standard)

Three-way adjustable VX hinge (on request)



Security lever / knob handle set with drilling and pull-off protection



Lock bolt for standard security



Solid steel security bolts on the hinge side

MULTI-PURPOSE DOOR

MZ Thermo / MZ ThermoPlus External door with thermal break and the best thermal insulation values

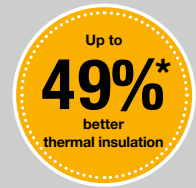

The multi-purpose doors are more than just extremely robust. Thanks to a thermal break, they feature up to 49 % better thermal insulation than conventional multi-purpose doors. They are available with or without glazing as well as in numerous colours and decor surfaces.



Product characteristics

Break-in resistance

★ ★

Thermal insulation

★ ★ ★ ★ ★

Acoustic insulation

★ ★

Fire-retarding

Stress

★ ★ ★ ★ ★

Deformation resistance

★ ★ ★ ★ ★

External door for

- Basements
- Heated outbuildings
- Garages with direct access to the home
- Workshops and hobby rooms

Ready-to-fit door set

Door leaf and frame with thermal break, galvanized and painted in Traffic white (similar to RAL 9016).

Single-leaf

Thermally insulated

MZ ThermoPlus

THP 011: $U_D = 0.87 \text{ W}/(\text{m}^2 \cdot \text{K})$

MZ Thermo

TPS 011: $U_D = 1.1 \text{ W}/(\text{m}^2 \cdot \text{K})$

TPS 021: $U_D = 1.4 \text{ W}/(\text{m}^2 \cdot \text{K})$

TPS 051: $U_D = 1.5 \text{ W}/(\text{m}^2 \cdot \text{K})$

TPS 021 / 051 glazing

Double insulated glazing (24 mm) with a U-value of up to $1.4 \text{ W}/(\text{m}^2 \cdot \text{K})$, with synthetic glazing frame



Colours and
decor surfaces

Page 27

Size range

Page 30

High thermal insulation

The MZ Thermo / MZ ThermoPlus multi-purpose door will help you reduce heating losses permanently. The door leaf with PU rigid foam infill, frame and threshold all come with a thermal break. This and the all-round double seals on all four sides make sure the door is perfectly sealed and improves thermal insulation by up to 49 % compared to a conventional multi-purpose door.

Stability and function

The MZ Thermo / MZ ThermoPlus is exceptionally stable and robust thanks to the fully filled door leaf. The door can be optimally adjusted using the three-way adjustable guide rollers.

With or without glazing

On request, the MZ Thermo also comes with glazing to let daylight into your workshop or hobby room. The glazed versions also offer excellent thermal insulation on the interior and exterior thanks to double insulated safety glass.



The multi-purpose door

MZ ThermoPlus offers first class thermal insulation with a 67-mm-thick door leaf and a particularly high U_D -value of up to $0.87 \text{ W}/(\text{m}^2 \cdot \text{K})$.



The multi-purpose door

MZ Thermo features a 46-mm-thick door leaf and a thermal insulation value of up to $1.1 \text{ W}/(\text{m}^2 \cdot \text{K})$.



Glazing frame Roundstyle
in TPS 021

You may choose from 3 styles:
with a solid door leaf or glazing.



THP 011 / TPS 011



TPS 021



TPS 051



Glazing frame Profilstyle
in TPS 051

* Up to 49 % better thermal insulation compared
to a conventional multi-purpose door

MULTI-PURPOSE DOOR

MZ

Stable and inexpensive
internal and external door

Proven for over four decades, this multi-purpose door is stable, durable and weather-resistant, making it ideal for inside and outside. The MZ comes in a single-leaf or double-leaf design and is available with glazing on request.



Product characteristics

Break-in resistance

★ ★

Thermal insulation

★ ★ ★ ★ ★

Acoustic insulation

★ ★

Fire-retarding

Stress

★ ★ ★ ★ ★

Deformation resistance

★ ★ ★ ★ ★

Internal and external door for

- Unheated outbuildings
- Utility sheds
- Storage rooms

Ready-to-fit door set

Door leaf and frame, galvanized and with powder-coated primer in Grey white (similar to RAL 9002).

Single- or double-leaf

Dual handed (with corner frame)

Thermally insulated

 $U_D = 1.7 \text{ W}/(\text{m}^2 \cdot \text{K})^*$

Acoustic-rated

 $R_w \text{ approx. } 39 \text{ dB}^*$

Possible additional functions:

T30 fire-retarding*

As an H8-5 fire-rated door up to door size 1000 × 2125 mm (see page 18)

* For doors without glazing and with corner frame

Stability for you

This ready-to-fit door set is especially robust thanks to a double-skinned, 45-mm-thick door leaf rebated on both sides, a sheet thickness of 0.9 mm, a mineral wool infill and steel reinforcement. The door provides a very high level of security with 2 solid steel security bolts. A 2-mm-thick corner frame with all-round EPDM seal keeps the door shut tight and has a bottom threshold rail that can be easily removed. The door is also available with a block frame and a 3-sided EPDM seal on request.



2-mm-thick corner frame with all-round seal

More light thanks to glazing

Hörmann also offers its MZ multi-purpose door with glazing. Due to security reasons, this glazing is kept very narrow, but it still lets you benefit from daylight inside. 7 mm wired glass is provided as standard, but 20 mm insulated wired glass with a view of 230 × 1360 mm is also possible. The natural-finish aluminium glazing frame is fastened on the opposite hinge side with glazing beads as standard. For doors opening inwards, the glazing frame is optionally available with glazing beads on the hinge side.



With glazing on request



FIRE-RATED DOOR

H8-5

The best-selling boiler room door in Europe



For decades, the fire-rated door H8-5 has been providing optimum safety for boiler rooms and rooms with oil tanks. This door is the best example of how you can benefit from Hörmann's expertise in fire protection.



Product characteristics

Break-in resistance

★ ★

Thermal insulation

★ ★

Acoustic insulation

★ ★ ★

Fire-retarding

★ ★ ★ ★ ★

Stress

★ ★ ★ ★ ★

Deformation resistance

★ ★ ★ ★ ★

Internal door for

- Boiler rooms
- Rooms with oil tanks

Ready-to-fit door set

Door leaf and frame, galvanized and with powder-coated primer in Grey white (similar to RAL 9002).

Single-leaf

Dual handed

T30 fire-retarding

acc. to DIN EN 1634

Thermally insulated

acc. to EN ISO 12567-1

$U_D = 1.7 \text{ W}/(\text{m}^2 \cdot \text{K})^*$

Acoustic-rated

Acc. to DIN 52210

Rw approx. 39 dB*

Possible additional functions:

Smoke-tight

Acc. to DIN 18095 with overhead door closer, smoke-tight seal and threshold**

* With all-round seal

**Not suitable for escape and rescue routes

Stable door leaf

The double-skinned, 45-mm-thick door leaf is rebated on two sides. With a sheet thickness of 0.9 mm it is highly stable and is equipped with a fire-retarding mineral wool infill, steel reinforcement and 2 steel security bolts. The lock and lever handle set may be used with profile cylinders and deadlock keys. One deadlock key is provided.

Integrated fire protection

On both the door and fire hatch the fire-proof material is not exposed but is concealed on the front side across the full width and flush-fitting.

Sealed all-round

The 2-mm-thick corner frame with all-round seal reliably seals the fire-rated door H8-5. The bottom threshold rail is easy to remove if fitted with a continuous floor.

Also as a smoke-tight door

On request, the H8-5 can be equipped with optional extras such as an overhead door closer, smoke-tight seal and threshold** to make it a smoke-tight door.



2-mm-thick corner frame with all-round seal



The model H8-5 fire hatch is recommended for rooms with oil tanks

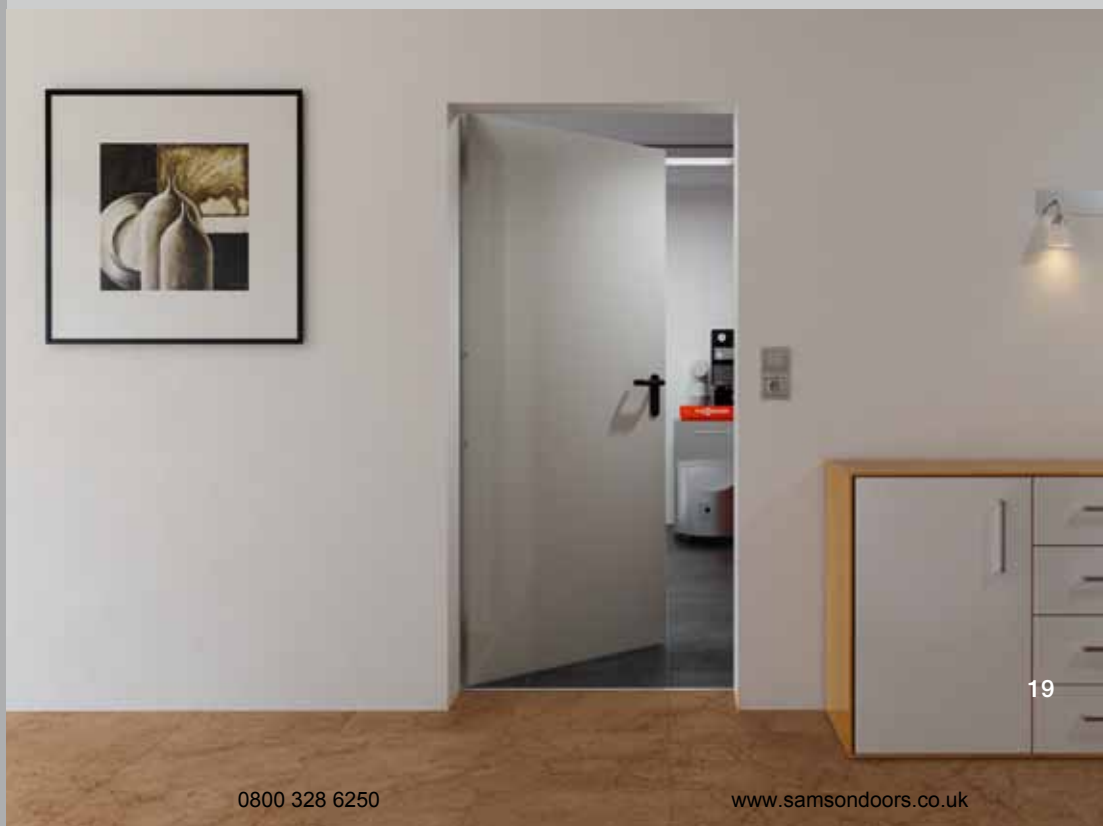

MULTI-FUNCTION DOOR

H3D

The functional door between garage and home



Due to fire hazards in garages, a fire-rated door between the house and garage is required by law. The H3D multi-purpose door is the best choice for this sensitive area. On request, this door can also act as a seal against smoke and engine noise and additionally protects your family from unwanted visitors with the WK 2 security package.



Product characteristics

Internal door for

the passage from the garage into the house

Ready-to-fit door set

Door leaf and frame, galvanized and with powder-coated primer in Grey white (similar to RAL 9002).

Single- or double-leaf

T30 fire-retarding
acc. to DIN EN 4102

Thermally insulated

$U_D = 1.9 \text{ W}/(\text{m}^2 \cdot \text{K})$

Possible additional functions / optional extras:

Smoke-tight

Acc. to DIN 18095

With the following optional extras:

- Retractable bottom seal or aluminium bottom profile with seal
- Overhead door closer and profile cylinder

Acoustic-rated*

acc. to DIN EN ISO 717.1

With the following optional extras:

- Bottom seal R_w 37 dB
- Aluminium bottom profile R_w 41 dB
- Threshold rail R_w 44 dB

Break-in-resistant WK 2**

acc. to DIN EN V 1627

With the following optional extras:

- 2 additional security bolts
- Drill-proof locking cylinder acc. to DIN 18252, P-3-BS
- Aluminium security fitting in acc. with DIN 18257, class ES 1

Glazings

- Clear F30 fire-proof glass
- Please note: glazed doors require an overhead door closer.

* The acoustic values apply to solid doors without glazing and are not applicable to doors fitted into gas concrete.

**The resistance class WK 2 applies to doors without glazing and is not applicable to doors fitted into partition walls.

Break-in resistance

★ ★ ★ ★ ★

Thermal insulation

★ ★

Acoustic insulation

★ ★ ★ ★ ★

Fire-retarding

★ ★ ★ ★ ★

Stress

★ ★ ★ ★ ★

Deformation resistance

★ ★ ★ ★ ★

Sturdy door leaf

The double-skinned, 45-mm-thick door leaf comes with a mineral wool infill, steel reinforcement and steel security bolts. The 2-mm-thick corner frame is equipped with a 3-sided EPDM seal and is easy to fit using grouting lugs.

With optional glazing

On request, the multi-function door H3D is available with clear fire-proof glass for more light. These doors are equipped with an additional overhead door closer.

Optional extras for further functions

You can increase the acoustic insulation and break-in-resistance of the H3D with various optional extras or even make it a smoke-tight door.

Four types of clear F30 fire-proof glass are available for the H3D.

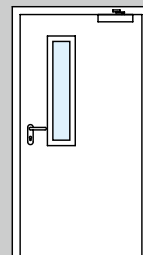

Glazing
View 1

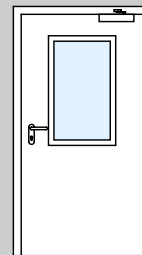

Glazing
View 2

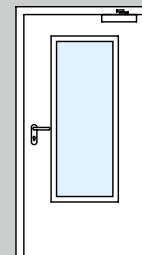

Glazing
View 3

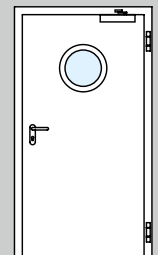

Round glazing
Ø 300, 400, 500 mm



FIRE-RATED SECURITY DOOR

WAT

As a passage from the garage into the home



With standard fire protection and security functions, the WAT is the right choice for the passage from the garage into the hallway of your home. With a thick rebate leaf design and numerous colour and decor options, the door blends in perfectly with the other internal doors in your home.



Product characteristics

Break-in resistance

★ ★ ★ ★ ★

Thermal insulation

★ ★

Acoustic insulation

★ ★ ★ ★

Fire-retarding

★ ★ ★ ★ ★

Stress

★ ★ ★ ★ ★

Deformation resistance

★ ★ ★ ★ ★

Internal door for

the passage from the garage into the home

Ready-to-fit door set

Door leaf and frame, galvanized and painted in Traffic white (similar to RAL 9016).

Single-leaf

T30 fire-retarding

acc. to DIN EN 1634

Smoke-tight

acc. to DIN EN 1634-3 with optional overhead door closer and bottom seal

Break-in-resistant, RC 2

acc. to DIN EN 1627

Thermally insulated*

$U_D = 1.8 \text{ W}/(\text{m}^2 \cdot \text{K})$

Acoustic-rated*

acc. to EN ISO 717-1

Rw approx. 38 dB

* Only in combination with a corner frame



Colours and decor surfaces

Page 27

Size range

Page 30

Stable and functional

The WAT features a double-skinned door leaf with a thick rebate design, an insert which is glued over the entire surface and sheet steel on both sides, making it especially stable. Door function and tightness are always ensured thanks to three-way adjustable hinges, seals on three sides and a retractable bottom seal.

Standard security and fire protection

The WAT provides a high level of security through its multiple-point locking which features a security lever/knob handle set with drilling and pull-off protection and 3 steel bolts to prevent forced opening. This and the fact that it can withstand a fire for at least 30 minutes make the WAT the right choice if fire protection and security are equally important to you.

Various surfaces

Hörmann offers the WAT in various surfaces, like, for example, the Decograin version. The door blends in perfectly with the other doors in your home thanks to this natural timber look.



Stable door leaf in a thick rebate design



Security lever / knob handle set with drilling and pull-off protection



Three-way adjustable galvanized guide rollers for easy door function

A solid steel bolt on the hinge side prevents forced opening



INTERNAL DOOR

ZK

The durable and
inexpensive door

Over many years, Hörmann ZK doors have proven themselves as robust doors for everywhere from the basement to the roof. ZK doors do not warp and come with a high-quality surface that is durable, resistant to stains and easy to clean. Reliable quality at a low price.



Product characteristics

Break-in resistance

Thermal insulation

★ ★

Acoustic insulation

Fire-retarding

Stress

★ ★ ★ ★

Deformation resistance

★ ★ ★ ★ ★

Internal door for

- Basements
- Children's rooms
- Entrance to an unrenovated loft

Door leaf or single, ready-to-fit door set

Door leaf and frame, galvanized and painted in Traffic white (similar to RAL 9016).

Single- or double-leaf

Thermally insulated

$U_D = 2.1 \text{ W}/(\text{m}^2 \cdot \text{K})^*$

Acoustic-rated

R_w approx. 25 dB*

Climatic class III

acc. to RAL-RG 426

Duty category S

acc. to RAL-RG 426

* For doors without glazing and with corner frame

Stable door leaf

The double-skinned, 40-mm-thick door leaf with a thick rebate on 3 sides consists of galvanized sheet steel (0.6 mm) and a honeycomb insert glued over the entire surface, making it dimensionally stable and robust.

Fully equipped as standard

As standard, you will receive the internal door ZK with a fitted lock and bright galvanized hinge top parts V 0020, firmly screwed into the reinforced sections, but without a lever handle set.

As just a door leaf or ready-to-fit with a frame

The internal door ZK is supplied as just a door leaf or as a ready-to-fit door set, i.e. complete with lever handle set and special corner frame in Traffic white.

Smooth, quiet closing

The door has a mortise lever/knob handle set in acc. with DIN 18251 class 3 and is prepared for profile cylinders (backset 55 mm). The door closes easily and quietly since it is equipped as standard with a plastic catch and steel bolt, deadlock insert and key, and on request with a profile cylinder.

Flexible fitting

Thanks to the height adjustment and individual surface design, ZK doors are also ideal for modernising any room from the basement to the roof. They can be flexibly used in existing standard frames and all Hörmann steel frames (prepared for series V 8000 hinges).

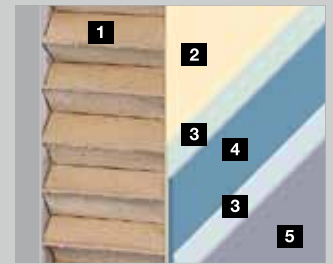

- 1 Honeycomb insert
- 2 Adhesive
- 3 Zinc coating
- 4 Steel
- 5 Powder-coating / foil-coating



You can individually design your door's smooth, silk matt surface.



The door leaf can be shortened at the bottom. With a height adjustment of up to 20 mm, this door is suitable for any modernisation project.

Optional extras

Page 20



Colours and decor surfaces

Page 27

Size range

Page 30

INTERNAL DOOR

Extra equipment for an individual design

Glazing shapes for internal door ZK



Round glazing
Ø 300 or 400 mm,
brushed stainless steel



Glazing view 5
Frame for galvanized door
leaf: paintable aluminium



Glazing view 6
Frame for powder-coated
door leaf: Aluminium
anodised in natural finish
(E6 / EV 1).



Glazing view 7
Frame for foil-coated
door leaf: stained timber,
matching the door leaf.



Glazing view 8
Frame for foil-coated
door leaf: stained timber,
matching the door leaf.



Masterpoint



Mastercarré



Masterligne

The glazing in the door

All ZK doors are available with glazing in the structures shown, with light 7 mm wired ornamental glass, 6 mm single-pane or laminated safety glass.

For on-site glazing, please note the pane thickness of 4 – 6 mm. Round glazing is only available from the factory.

Optional extras for internal door ZK



Plastic ventilation grille
(455 x 90 mm)



Wide-angle spyhole

Lever handle sets in various shapes and surfaces for internal door ZK



Plastic in black, red,
brown, white and yellow



Stainless steel



Aluminium

COLOURS AND DECOR SURFACES

Whatever you want!

Preferred colours*

Hörmann steel doors come in 16 inexpensive preferred colours and all RAL colours. Surfaces are powder-coated with a high-quality primer (painted for external doors) which makes them especially resistant and durable.

All colours based on RAL.



RAL to choose

The security door KSI and internal door ZK are available in all RAL colours on request.

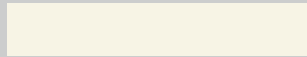

Cream** RAL 9001

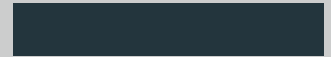

Anthracite grey RAL 7016



Grey aluminium** RAL 9007

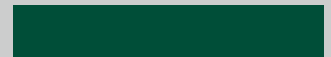

Moss green RAL 6005

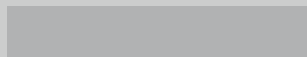

White aluminium RAL 9006



Pigeon blue RAL 5014

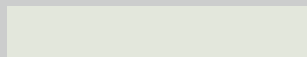

Grey white** RAL 9002

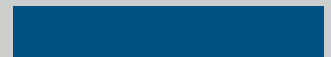

Gentian blue** RAL 5010

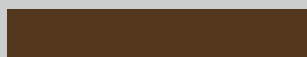

Terra brown RAL 8028



Purple red RAL 3004



Clay brown RAL 8003



Ruby red RAL 3003



Window grey RAL 7040



Flame red** RAL 3000

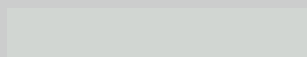

Light grey RAL 7035

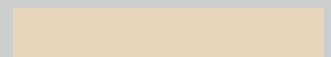

Light ivory RAL 1015

Decors*

For a natural and exclusive door style, we offer high-quality decors in 9 true-to-original timber looks as well as the especially elegant Titan Metallic CH 703 decor.



Golden Oak

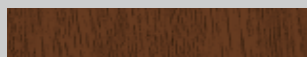

Dark Oak



Night Oak



Winchester Oak (only MZ Thermo / MZ ThermoPlus / KSI Thermo)

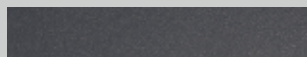

Titan Metallic CH 703 (only MZ Thermo / MZ ThermoPlus / KSI Thermo)

Only for internal doors

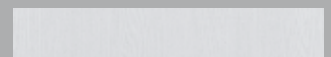

White Ash



Light Oak



Beech



Melinga Dark

* Except for MZ, H8-5, H3D

**Except for KSI, MZ, H8-5, H3D, ZK

STEEL FRAMES

Proven and inexpensive frames

Hörmann steel frames are especially robust and can withstand “accidents” with toy cars or run-ins with hard objects. The hot-galvanized, powder-coated primer surface can be painted individually, letting you match it perfectly to the look of the steel or timber doors used.



Product characteristics

Corner and profile frames for 40-mm-thick rebated door leaves

Ready-to-fit standard frames galvanized and with powder-coated primer in Light grey (similar to RAL 7035).

Availability

- Ready-to-fit and welded
- To screw or clamp

Fitting in

- Brickwork
- Partition wall

Corner or profile frame

How do you want to use your internal door? This question must be answered before you select your frame. If installed in brickwork, in the basement for example, an inexpensive corner frame is all you need. However, for the living areas we recommend a profile frame enveloping the wall. Partition wall frames are always designed as profile frames and are ideal for dry loft constructions.

Welded or to screw or clamp

All Hörmann standard frames for brickwork or partition walls are ready-to-fit and welded or to screw or clamp. They come in a handy package that can be transported in a car and are already prepared for easy fitting by yourself.

Variety is our strength

We have every frame you could possibly need. We offer door and window frames or passage frames between rooms. The frames are also available with segmental arches or Norman arches as well as in combination with a side element and transom light. All frames are additionally available in a final coating in any RAL colour or an elegant stainless steel version. We would be pleased to advise you.

Flexible, long-lasting, elegant: VarioFix frame

For the new Hörmann steel profile frame VarioFix, wall tolerances of up to 20 mm are no longer a problem: The adjustable decorative rebate compensates for different wall thicknesses during renovations and new construction projects. As easy to fit as a timber frame, the steel frame is additionally distinguished by its long service life and attractive design. Only VarioFix offers high resistance and an elegant shape coupled with the fitting principle of timber frames.

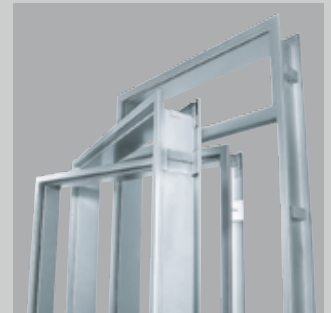

Corner and profile frames



Screw or clamp frame

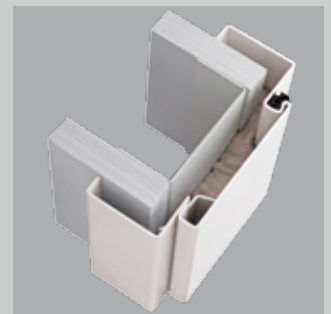

Profile frame VarioFix

Bottom image:

Sliding door frame for glass and timber pocket doors.



SIZE RANGE OVERVIEW

Standard sizes	External Doors				Internal doors				
	Security door		Multi-purpose door		Fire-rated door		Multi-function door	Fire-rated security door	Internal door
	KSI Thermo	KSI	MZ Thermo / MZ Thermo Plus	MZ	H8-5 door	H8-5 hatch	H3D	WAT	ZK
Single-leaf doors									
750 x 875						●			
800 x 800						●			
875 x 875						●			
875 x 1000						●			
875 x 1250						●			
875 x 2000	●		●						
875 x 2125	●		●						
625 x 2000									●
750 x 1750				●	●				
750 x 1875				●	●				●
750 x 2000		●		●	●		●	●	●
750 x 2125		●					●	●	●
800 x 1800				●	●				
800 x 1875				●	●				
800 x 2000				●	●				
875 x 1750				●	●				
875 x 1800				●	●				
875 x 1875		●		●	●		●		●
875 x 2000		●		●	●		●	●	●
875 x 2125		●		●	●		●	●	●
1000 x 1875		●		●	●				●
1000 x 2000	●	●	●	●	●		●	●	●
1000 x 2100	●		●						
1000 x 2125	●	●	●	●	●		●	●	●
1100 x 2100	●		●						
1125 x 2000							●		
1125 x 2125				●			●		●
1250 x 2000				●					●
1250 x 2125				●					●
Double-leaf doors									
1500 x 2000				●			●		●
1500 x 2125							●		●
1750 x 2000				●			●		●
1750 x 2125							●		●
2000 x 2000				●			●		●
2000 x 2125				●			●		●
2125 x 2125							●		
2250 x 2250							●		

Please state handing on order!



Left-hand hinged



Right-hand hinged

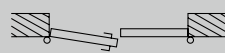

Traffic leaf left-hand hinged

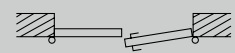

Traffic leaf right-hand hinged

Special sizes	External Doors				Internal doors				
Ordering size (nominal size)	Security door		Multi-purpose door		Fire-rated door		Multi-function door	Fire-rated security door	Internal door
	KSI Thermo	KSI	MZ Thermo / MZ Thermo Plus	MZ	H8-5 door	H8-5 hatch	H3D	WAT	ZK
Single-leaf doors									
Width	875 – 1250	625 – 1250	875 – 1250	625 – 1250	625 – 1000	625 – 1000	625 – 1125	625 – 1164	500 – 1250
Height	1875 – 2250	1700 – 2250	1875 – 2250*	1570 – 2134	1750 – 2125	800 – 1749	1750 – 2250	1964 – 2132	1500 – 2250
Double-leaf doors									
Width				1250 – 2250			1375 – 2250		1500 – 2500
Height				1570 – 2134			1750 – 2250		1500 – 2250

Frames	Corner frame	Profile frame
Ordering size (nominal size)		
625 × 2000	●	●
750 × 2000	●	●
875 × 2000	●	●
1000 × 2000	●	●
625 × 2125	●	●
750 × 2125	●	●
875 × 2125	●	●
1000 × 2125	●	●

Profile frame	Brickwork	Partition wall	Gypsum plasterboard
Wall widths (MW)			
75		●	
80	●		●
100	●	●	●
125		●	
130	●		
145	●		
150		●	
160	●		
180	●		
205	●		
270	●		
290	●		
330	●		

DIMENSIONAL REFERENCES

External multi-purpose doors MZ Thermo / MZ ThermoPlus, external security door KSI Thermo

Vertical view

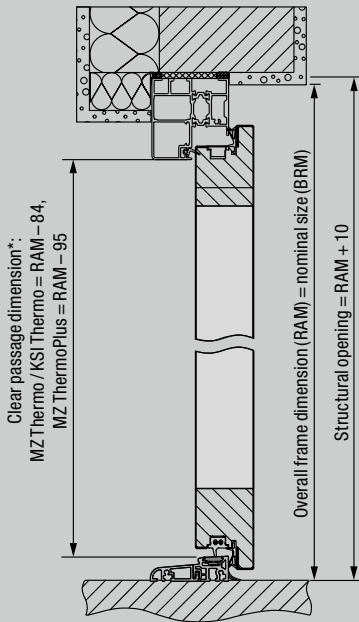

Horizontal view

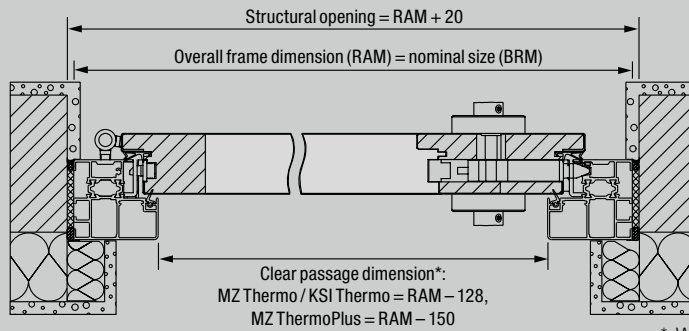

* With an opening angle of 90° and without handles and levers, the clear passage width is reduced by 2 mm.

Fitting versions

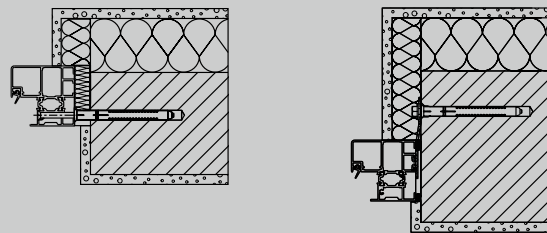

Block frame
Fitting to brickwork
Countersunk fitting

Block frame
Anchor fitting

KSI security door

Vertical view

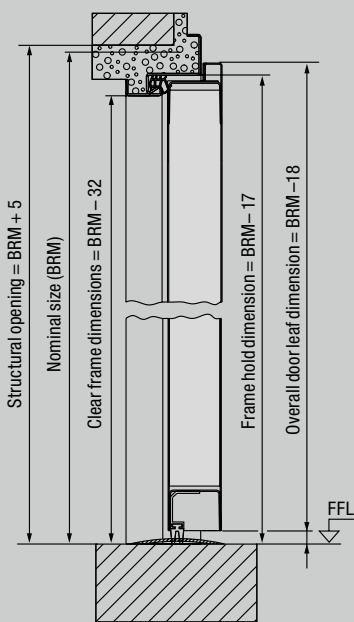

Horizontal view

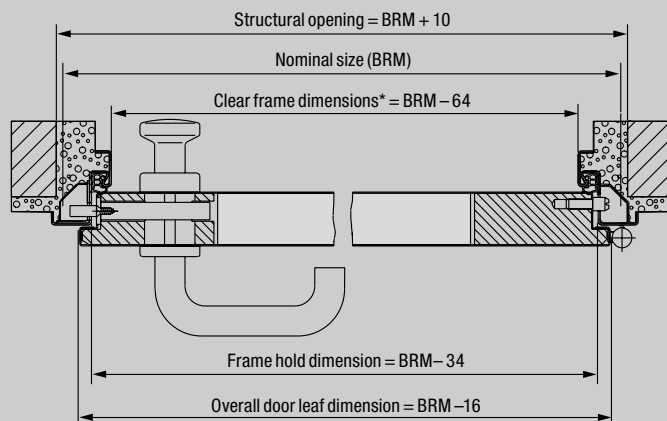

* With an opening angle of 90° and without handles and levers, the clear passage width is reduced by 2 mm.

Fitting versions

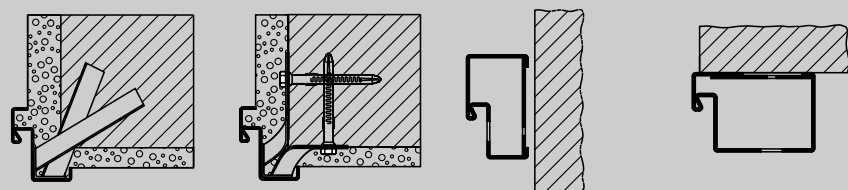

Fitting with grouting lugs

Fitting with grouting lugs / screw-fixing

Block frame for fitting in the opening (profile 21101)

Block frame for fitting on the wall (profile 006) (tested on the hinge side)

DIMENSIONAL REFERENCES

Multi-purpose door MZ, fire-rated door H8-5

Vertical view

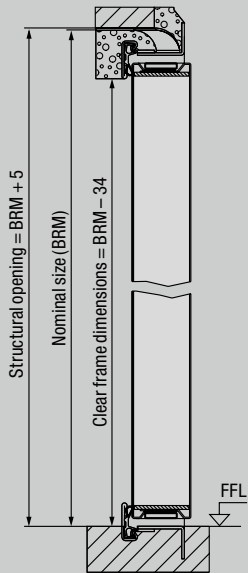

Horizontal view

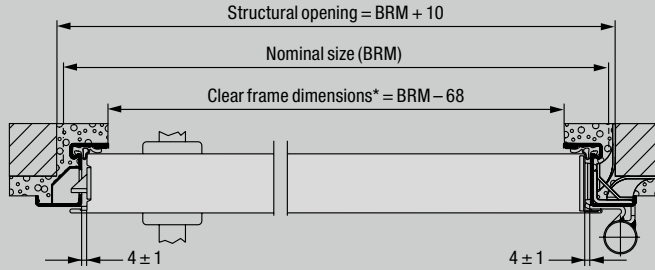

* With an opening angle of 90° and without handles and levers, the clear passage width is reduced by 25 mm.

Fitting versions

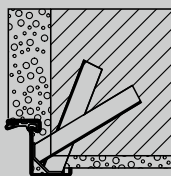

Fitting with grouting lugs

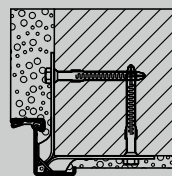

Fitting with grouting lugs / screw-fixing

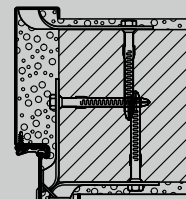

Corner and counter frame
Fitting with grouting lugs / screw-fixing

Multi-function door H3D

Vertical view

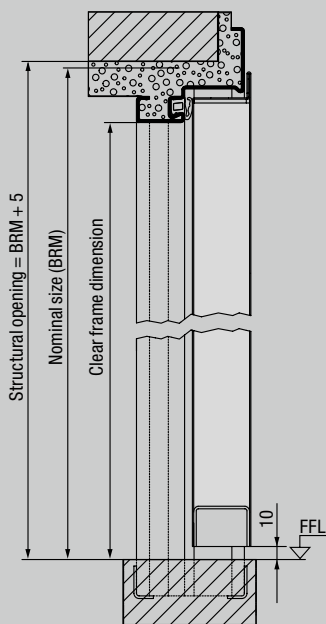

Horizontal view

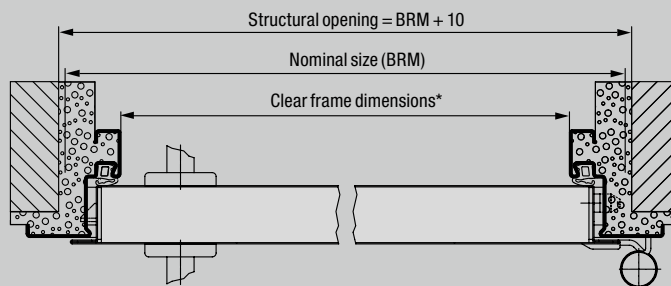

* With an opening angle of 90° and without handles and levers, the clear passage width is reduced by 93 mm.

Fitting versions

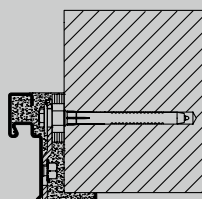

Corner frame
with concealed plug-and-screw fitting

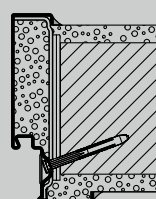

Profile frame
Diagonal fixing up to MW 175

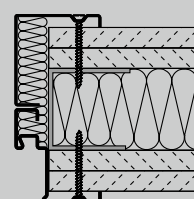

Corner and counter frame
Screw fixing

This door comes in a variety of other frame types. For more information, please contact your Hörmann partner.

DIMENSIONAL REFERENCES

Fire-rated security door WAT

Vertical view

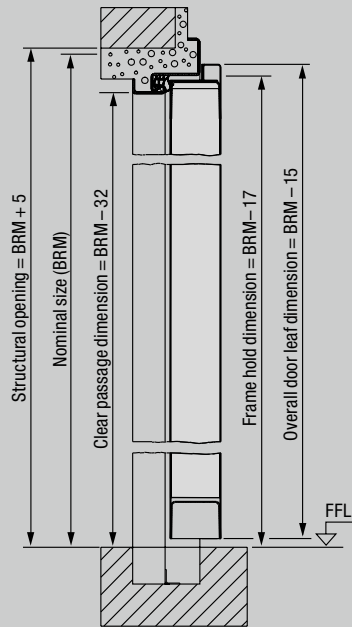

Horizontal view

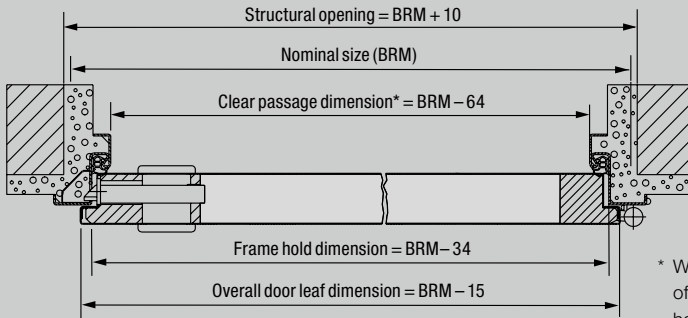

* With an opening angle of 90° and without handles and levers, the clear passage width is reduced by 2 mm.

Fitting versions

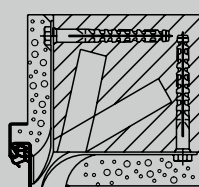

Corner frame
Fitting to brickwork
Grouting lugs

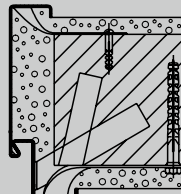

Profile frame
Fitting to brickwork
Grouting lugs

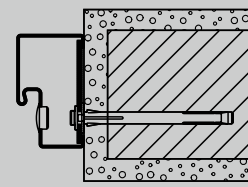

Block frame
Fitting to brickwork
Plug-and-screw fitting

Internal door ZK

Vertical view

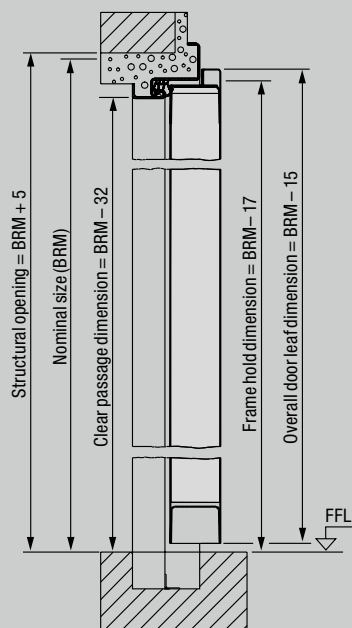

Horizontal view

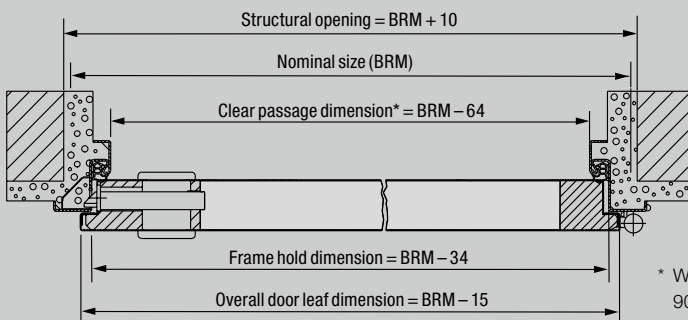

* With an opening angle of 90° and without handles and levers, the clear passage width is reduced by 2 mm, and by 4 mm in the case of double-leaf doors.

Fitting versions

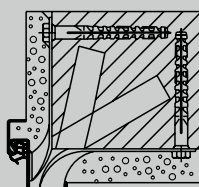

Corner frame
Fitting to brickwork
Grouting lugs

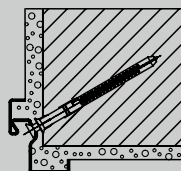

Special corner frame
Plug-and-screw fitting
through the groove
bottom

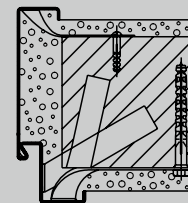

Profile frame
Fitting to brickwork
Grouting lugs

WALL CONNECTIONS

Corner frame DIN 18111 for brickwork

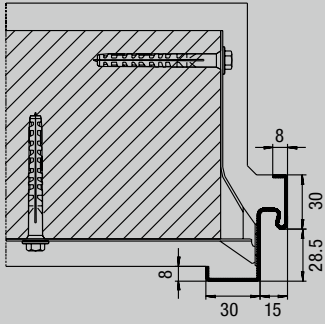

Profile 11100

Profile frame DIN 18111 for brickwork

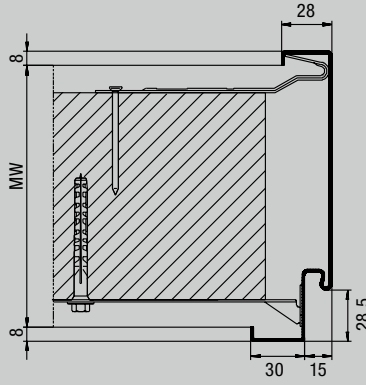

Profile 21100

Profile frame B 45 for gypsum plasterboard

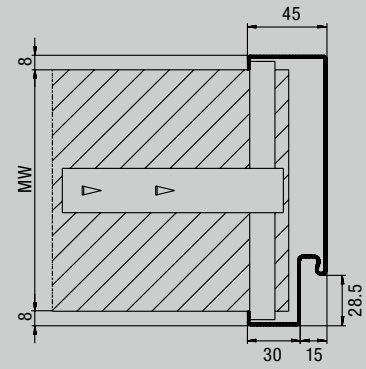

Profile 21101

Profile frame for partition walls

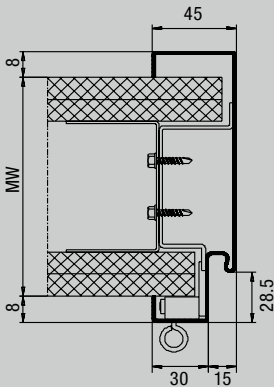

Profile 21120

Knock-down profile frame for partition walls 3-part for retrofitting

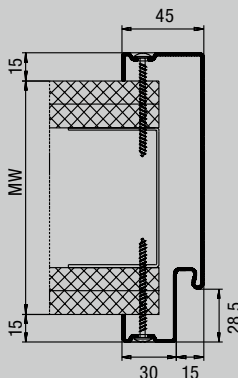

Profile 21120
Screw fixing

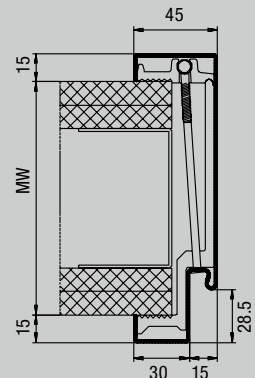

Profile 21120
Clamp jaw fixing

Double-shell profile frame for partition walls For retrofitting

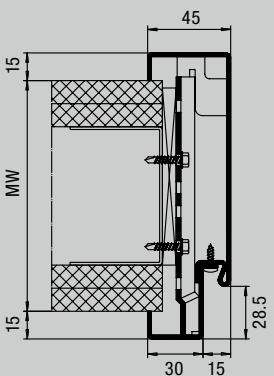

Profile 21180
rebated



TIMBER INTERNAL DOORS

Discover a new feeling of home: high quality timber internal doors

Timber internal doors give your home an extra level of comfort. Hörmann offers a comprehensive programme of beautiful door designs, various handle variants and a selection of surfaces. In addition, the extremely impact-resistant Duradecor surface finish will convince you with regard to ease of care and robustness. Whether classic or modern, white lacquer or real wood veneer, with glass elements or stainless steel embellishments – Hörmann offers you the timber internal door that suits you and your furnishings perfectly.



Timber internal door BaseLine



Timber internal door DesignLine



Timber internal door with panel design, e. g. DesignLine Carolina

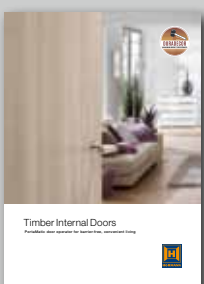

You can find more information in our Timber Internal Doors catalogue.



All-glass sliding doors



Experience Hörmann quality in new construction and modernisation

Hörmann provides an excellent basis for comprehensive planning. Carefully matched solutions offer you the very best in perfectly designed products for every area.

- **Garage doors**

Optimally match your personal architectural style: up-and-over or sectional doors made of steel or timber.

- **Door operators**

Enjoy extra convenience and break-in-resistant security with Hörmann operators for garage doors and entrance gates. You can profit from the convenience of Hörmann door operators in your residential space as well.

- **Entrance doors**

Our comprehensive entrance door ranges include models that fit almost every need and requirement.

- **Steel doors**

Sturdy doors for your entire home, from basement to roof.

- **Frames**

Choose from our comprehensive range of products for new construction, expansion and modernisation.



Garage doors and entrance gate operators



ThermoPro entrance door



Steel doors