

Markilux 3300 Technical Brochure



EMAIL: ENQUIRIES@SAMSONAWNINGS.CO.UK
TELEPHONE: (01933) 448844
MON - FRI 8:30AM - 5:30PM



Cassette awning

markilux 3300

The awning for purists – straight-lined simplicity for the domestic and commercial minimalist.

Product characteristics

Wind resistance class 2

Beaufort 5 → 7.5–10.4 m/s → 28–37 km/h → 17–23 mph

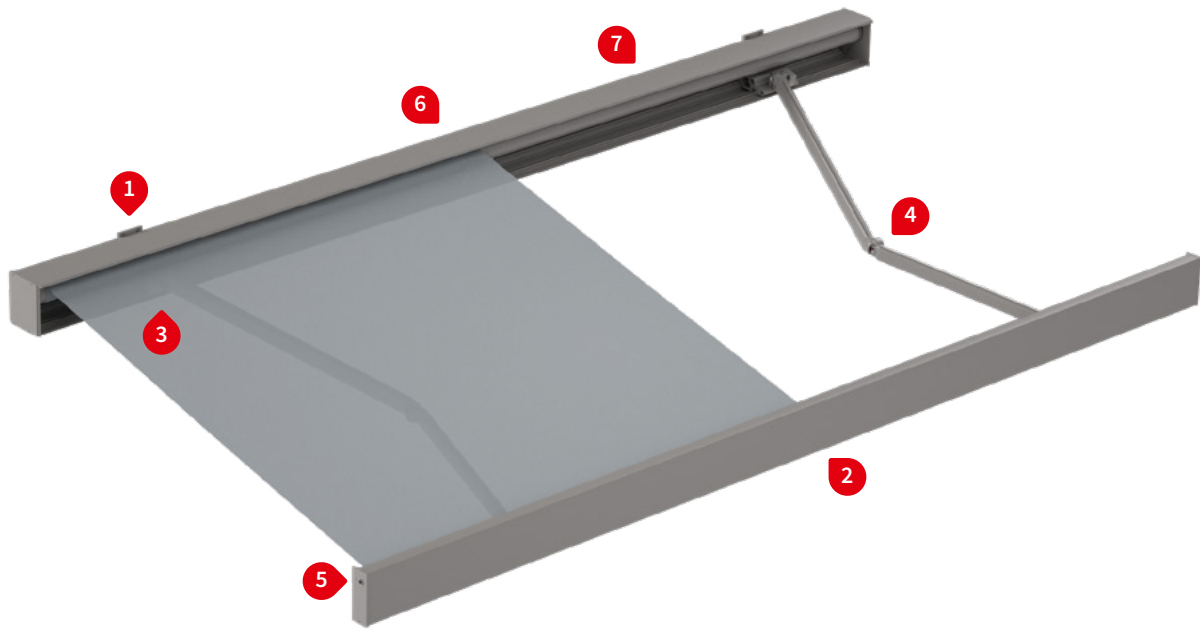

01
02
03
04
05
06
07
08
09
10
11
12
13
14
15
16
17

1 face fixture

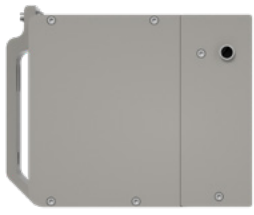

1 top fixture



2 awning retracting horizontally, irrespective of the awning pitch

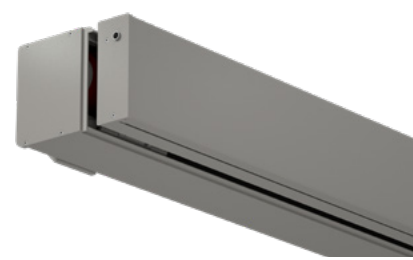

3 arm bearer with tilt device technology, integrated windlock mechanism

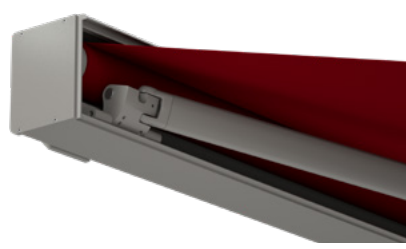

4 bionic tendon made of high-tech fibres for optimum power transference



5 hidden gutter in the front profile with water drainage holes to the side

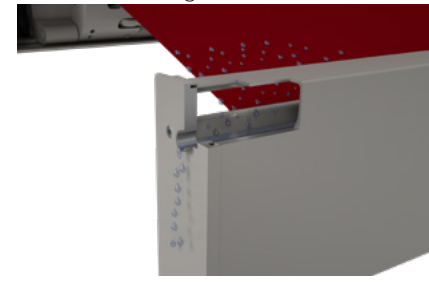

6 rolltex bearing for the roller tube, used in larger awning widths

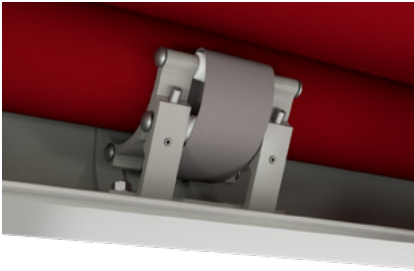

7 rubber wall sealing strip



Product characteristics

Description

- extremely robust, angular cassette, ideally suited for installation in niches and reveals, under overhangs and to business premises.

Special features

- the smooth appearance with flat front profile is perfectly suited to a minimalist building style
- the design characteristics allow the awning to be fitted into niches and reveals
- the tilt device technology with integrated windlock mechanism functioning as arm bearers ensures the awning closes cleanly
- option of a wall seal by means of an additional aluminium profile with rubber sealing strip
- option of a silentec motor – motor noise is appreciably reduced

Dimensions

- cassette in the standard version: depth 224 mm, height 192 mm
- single unit: minimum width 190 cm at the smallest projection of 150 cm
maximum width 700 cm at the largest projection of 400 cm
- also available as a coupled unit

Roller tube and lateral bearings

- round roller tube Ø 85 mm with keyway, galvanised steel – excellent stability ensures near perfect cover performance even at the largest widths
- the roller support bracket is made of extruded aluminium, integrated into the cassette

Awning profiles

- extruded aluminium, in façade quality, powder coated
- cassette made of a single extruded profile, with continuous keyways for infinitely variable bracket positions
- the front profile is shaped like a smooth panel, with integrated rain gutter

Folding arms

- profiles in extruded aluminium, in façade quality, powder coated
- moving parts made of drop-forged aluminium – the arms are therefore extremely fracture resistant
- pivot bolts in stainless steel run in Teflon-coated bronze bushes – practically maintenance free, virtually silent and extremely hard-wearing
- power transference via the innovative bionic tendon at the elbow joint, made of high tensile, hightech fibres – low in friction, noiseless, insensitive to corrosion and UV resistant, independently tested by the Fraunhofer Institute

Side caps

- the cassette side cheeks are made of extruded aluminium, powder coated
- the front profile end caps are made of extruded aluminium, powder coated, with water drainage holes

Fixture brackets

- face fixture, top fixture, eaves fixture
- extruded aluminium, powder coated
- available in intermediate widths made to order (on request)
- awning pitch adjustment range 5°–45°
- spacer plates, stand-off brackets and other accessories are available

01 **Frame and end cap colours**

markilux frame colours without surcharge

02 traffic white RAL 9016

metallic aluminium RAL 9006

grey brown, similar to RAL 8019



06
07 off-white textured finish, 5233 ¹⁾

stone grey metallic, 5215 ¹⁾

anthracite metallic, 5204 ¹⁾



11 Havana brown textured finish, 5229 ¹⁾



Non-standard powder-coated finish

Bespoke frame colours at a surcharge – matt, metallic and pearl finishes as well as other colour ranges (DB, Tiger etc.) on request. All frame colours are available at a surcharge with enhanced corrosion protection.

1) textured finish

Colours may differ slightly from those depicted in both hue and finish.

Dimensions and configuration options

Single unit

		Overall awning width									Minimum width					
		250	300	350	400	450	500	550	600	650	700 ¹⁾	Motor			Crank handle	
Order dimensions		190	251	301	351	401	451	501	551	601	651					
		250	300	350	400	450	500	550	600	650	700					
H	150	3)										203	190	—	203	190
	200	3)	3)									253	240	—	253	240
	250	—	3)	3)								303	290	—	303	290
	300	—	—	3)	3)							353	340	—	353	340
	350	—	—	—	3)	3)					1) 2)	403	390	650	403	390
	400 ¹⁾	—	—	—	—	3)	3)					453	440	700	—	—

dimensions in cm

- 1) = only available with motor drive (surcharge)
- 2) = no intermediate sizes possible below width of 650 cm
- 3) = observe the minimum widths!
- H = extension

- = 2 folding arms, 2 brackets
- = 2 folding arms, 4 brackets
- = 2 folding arms, 5 brackets, 1 rolltex bearing
- = 3 folding arms, 4 brackets, 2 rolltex bearings
- = 3 folding arms, 6 brackets, 2 rolltex bearings

- = 2 standard arms
- = 2 bespoke arms (surcharge)
- = 3 standard arms

Operation	standard	optional
crank handle	✓	—
spring-assisted crank handle	—	✓
hard-wired motor	—	✓
silentec motor (optionally with an external io / RTS receiver) ¹⁾	—	✓
radio-controlled motor io, 868 MHz	—	✓
radio-controlled motor RTS, 433 MHz	—	✓
radio-controlled motor RTS, 433 MHz with manual override ¹⁾	—	—

1) for awnings with a maximum of 2 arms

Coupled Awning (only with motor drive) ¹⁾
2 fields, 1 motor, maximum width 1390 cm
3 fields, 1 motor, maximum width 1950 cm
maximum projection (depending on the width) 400 cm
junction roller
optionally with a one-piece cover (maximum of 2 fields / 15° pitch)

1) **N.B!** Important background information can be found in the chapter “General Information”, in the section “Coupled Awnings”.

Awning cover	fabric range no.	standard	optional
sunvas	301.. / 309..-315..	✓	—
perla	370 ..	—	✓
sunsilk	324.. / 325.. / 328.. / 369..	✓	—
perla FR	374.. / 375..	—	✓
perfotex	331.. / 332..	—	—
transolair	338..	—	—
vuscreen Alu	317..	—	—
Soltis Perform 92	92-20..	—	—
glass fibre screen	272..	—	—
valance, height 20 cm		—	✓

Shadeplus / drop valance
not available

01	Optional accessories
	wall connection profile (in pieces) with rubber sealing strip
02	valance
	infrared heater 2500 W
03	infrared heater 2500 W with integrated radio-controlled receiver 868 MHz io
04	LED spotline – light bar 110 × 70 mm with 5 W LED spotlights, width 180 cm / 3 spots or 300 cm / 5 spots
05	LED spotline io – light bar 110 × 70 mm with 5 W LED spotlights with integrated dimmable radio-controlled receiver, width 180 cm / 3 spots or 300 cm / 5 spots
06	automatic controls (light, wind, rain)

N.B! Important background information can be found in the chapter “Optional Accessories”.

07

08

09

10

11

12

13

14

15

16

17

Fixture brackets	
face fixture bracket 100 mm	71994.
face fixture bracket 60 mm	71995.
face fixture bracket 200 mm	71996.
face fixture bracket profile, undrilled, by the metre (max. 2m)	71997.
spreader plate A 430 × 160 × 12 mm	75328.
spreader plate B 300 × 400 × 12 mm	75327.
markilux panel 250 × 230 × 49 mm	76308.
markilux panel continuous	76380.
stand-off bracket wide 80–300 mm	77968.
stand-off bracket narrow 80–300 mm	77967.
top fixture bracket 90 mm	71651.
top fixture bracket 200 mm	71652.
top fixture bracket profile, undrilled, by the metre (max. 2 m)	701635
eaves fixture bracket 90 mm, 150 mm plate	71612.
eaves fixture bracket 90 mm, 270 mm plate	71659.
flat plate and angled bracket for eaves fixture, machine finish, 500 mm plate	716620
spreader plate 260 × 60 × 12 mm for eaves fixture bracket	75383.

Bracket fixture range

Awning with 2 folding arms

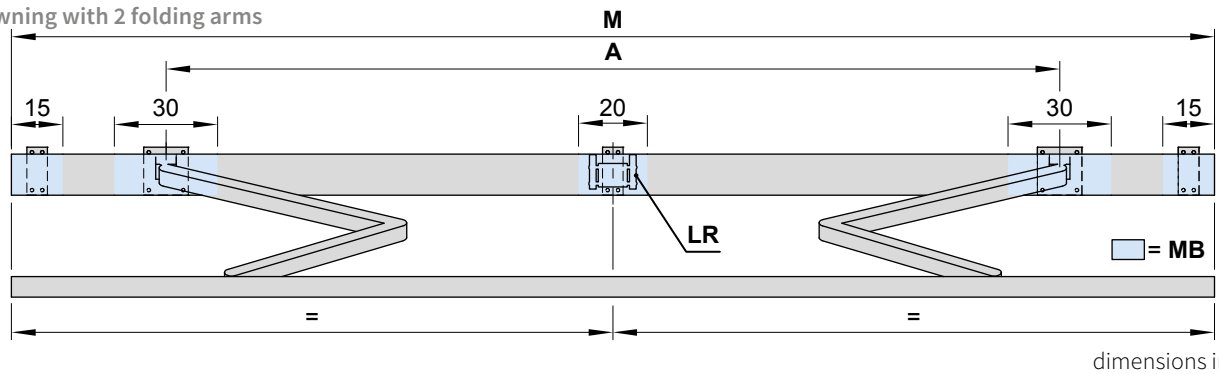

		Overall awning width								
		250	300	350	400	450	500	550	600	650
Order dimensions		190	251	301	351	401	451	501	551	601
		250	300	350	400	450	500	550	600	650
		Arm position A								
H	150	168 ¹⁾	230	260	300	340	380	410	450	490
	200	205 ²⁾	218 ¹⁾	260	300	340	380	410	450	490
	250	—	255 ²⁾	268 ¹⁾	300	340	380	410	450	490
	300	—	—	305 ²⁾	318 ¹⁾	340	380	410	450	490
	350	—	—	—	355 ²⁾	368 ¹⁾	380	440	450	—
	400	—	—	—	—	405 ²⁾	418 ¹⁾	440	450	—
BHT		No. of brackets No. of fixing points								
W	6	—	—	—	2 4	3 6	—	—	—	—
	10	2 6	—	—	2 6	2 6	—	—	—	—
	20	—	—	2 8	—	—	—	—	—	—
BP		A 2 16 B 2 8	A 2 16 B 2 8	A 2 16 B 2 8	A 2 16 B 2 8	A 2 16 B 2 8	A 2 16 B 2 8	A 2 16 B 2 8	A 2 16 B 2 8	A 2 16 B 2 8
DP		—	—	—	2	3	—	—	—	—
PA		2 8	2 8	2 8	4 16	5 20	—	—	—	—
DE	9	2 8	—	—	4 16	5 20	—	—	—	—
	20	—	—	2 12	—	—	—	—	—	—
DA	9	2 8	2 8	2 8	4 16	5 20	—	—	—	—

If the brackets cannot be positioned in accordance with this table, make sure the actual measurements are noted on the order form! If awnings are installed directly next to each other, a minimum distance of 50 mm must be maintained. dimensions in cm

The **pull-out forces** necessary for determining the correct fixing materials necessary to meet wind resistance class 2 (Beaufort 5) can be found in the password-protected dealer area of the markilux.com website under "Pull-out Forces".

- 1) = coupled awning in intermediate widths available on request with junction roller
- 2) = please note the minimum widths! Dimension A is only valid for standard arms! Dimension A is 13 cm smaller in the case of bespoke arms. Coupled units are not available with junction roller
- A = arm position
- BHT = bracket width
- BP = spreader plate A or B, to be positioned behind the folding arm
- DA = eaves fixture bracket
- DE = top fixture bracket
- DP = spacer plate 71642, to be positioned behind the rolltex bearing, in the case of spreader plate A or B
- H = *order dimension* = extension
- LR = rolltex bearing
- M = *order dimension* = awning width
- MB = bracket fixture range
- PA = markilux panel, fixture profile, width 250 mm
- W = face fixture bracket

Bracket fixture range

Awning with 3 folding arms

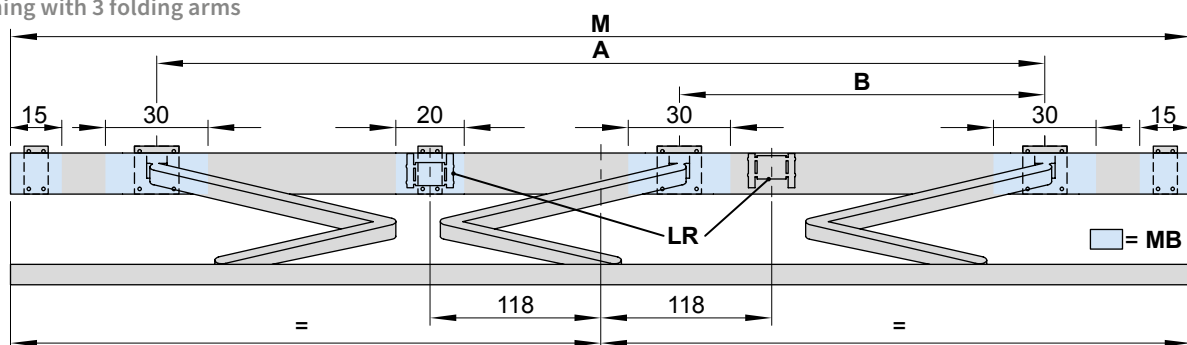

dimensions in cm

07

Overall awning width

650	700
-----	-----

Order dimensions

	651 700	651 689	700
--	------------	------------	-----

Arm position

		Arm position							
		A	B	A	B	A	B	A	B
H	150	—	—	540	250	—	—	—	—
	200	—	—	540	250	—	—	—	—
	250	—	—	550	235	—	—	—	—
	300	—	—	580	235	—	—	—	—
	350	615 ¹⁾	230 ¹⁾	—	—	615 ¹⁾	230 ¹⁾	640 ¹⁾	230 ¹⁾
	400	—	—	—	—	—	—	665 ¹⁾	235 ¹⁾

BHT

No. of brackets | No. of fixing points

		No. of brackets No. of fixing points	
		A	B
W	6	1 2	3 6
	10	—	3 9
	20	3 12	—
BP		A 3 24 ²⁾ B 3 12 ²⁾	A 3 24 B 3 12
DP		1	3
PA		4 16	6 24
DE	9	1 4	6 24
	20	3 18	—
DA	9	4 16	6 24

If the brackets cannot be positioned in accordance with this table, make sure the actual measurements are noted on the order form! If awnings are installed directly next to each other, a minimum distance of 50 mm must be maintained. dimensions in cm

The **pull-out forces** necessary for determining the correct fixing materials necessary to meet wind resistance class 2 (Beaufort 5) can be found in the password-protected dealer area of the markilux.com website under "Pull-out Forces".

- 1) = coupled units are not available with junction roller
- 2) = face fixture with spreader plate A or B including 3 face fixture brackets 100 mm 71994. and 1 face fixture bracket 60 mm 71995.
- A, B** = arm position
- BHT** = bracket width
- BP** = spreader plate A or B, to be positioned behind the folding arm
- DA** = eaves fixture bracket
- DE** = top fixture bracket

- DP** = spacer plate 71642, to be positioned behind the rolltex bearing, in the case of spreader plate A or B
- H** = *order dimension* = extension
- LR** = rolltex bearing
- M** = *order dimension* = awning width
- MB** = bracket fixture range
- PA** = markilux panel, fixture profile, width 250 mm
- W** = face fixture bracket

Face fixture

Fixtures, fittings and accessories

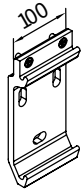

face fixture bracket
100 mm

71994.

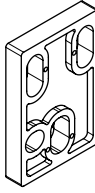

spacer plate
100 × 150 × 20 mm

N.B!
Stack to a max. height of 200 mm

758831

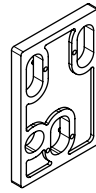

spacer plate
100 × 150 × 12 mm

758841

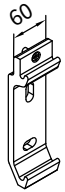

face fixture bracket
60 mm

71995.

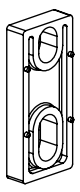

spacer plate for face fixture
60 × 140 × 20 mm

N.B!
stack to a max. height of 200 mm

716321



spacer plate for face fixture
60 × 140 × 12 mm

71642.

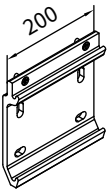

face fixture bracket
200 mm

71996.

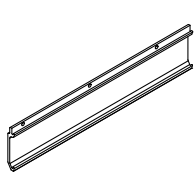

face fixture bracket
by the metre, undrilled

71997.

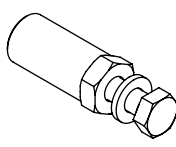

bolt reduction assembly
pack 10 pcs

M 16 → M 12 | M 16 → M 10 | M 12 → M 10 | M 10 → M 10

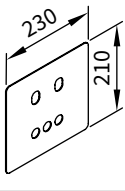

cover plate
for spacer plate
and stand-off brackets
in the case of external
insulation

230 × 210 × 2 mm

71843.

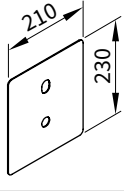

cover plate
for spacer plate
and stand-off brackets
in the case of external
insulation

210 × 230 × 2 mm

71844.

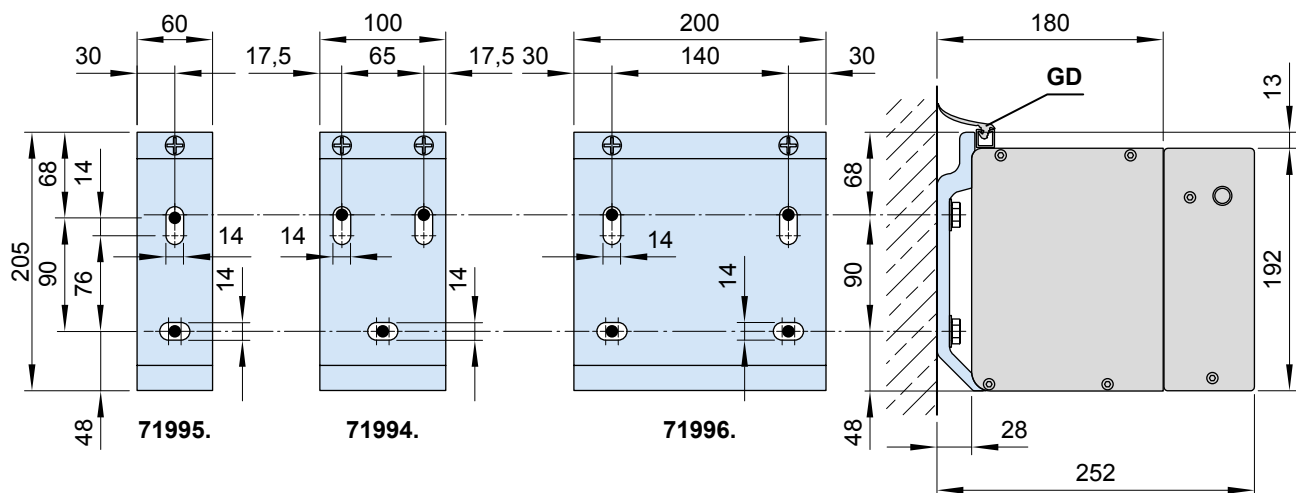

GD = rubber sealing strip

dimensions in mm

01 **Face fixture with spreader plate A**

02 Fixtures, fittings and accessories

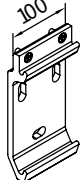
03  face fixture bracket
100 mm
04
05 **71994.**

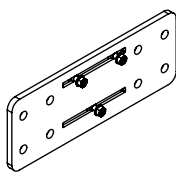
03  spreader plate A
face fixture
430 × 160 × 12 mm
04
05 **75324.**

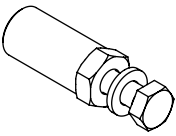
03  bolt reduction assembly
pack 10 pcs
04
05 M 16 → M 12 | M 16 → M 10 | M 12 → M 10 | M 10 → M 10

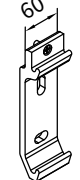
06  face fixture bracket
60 mm
07 **71995.**

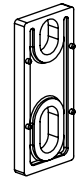
06  spacer plate for face
fixture
60 × 140 × 12 mm
07 **71642.**

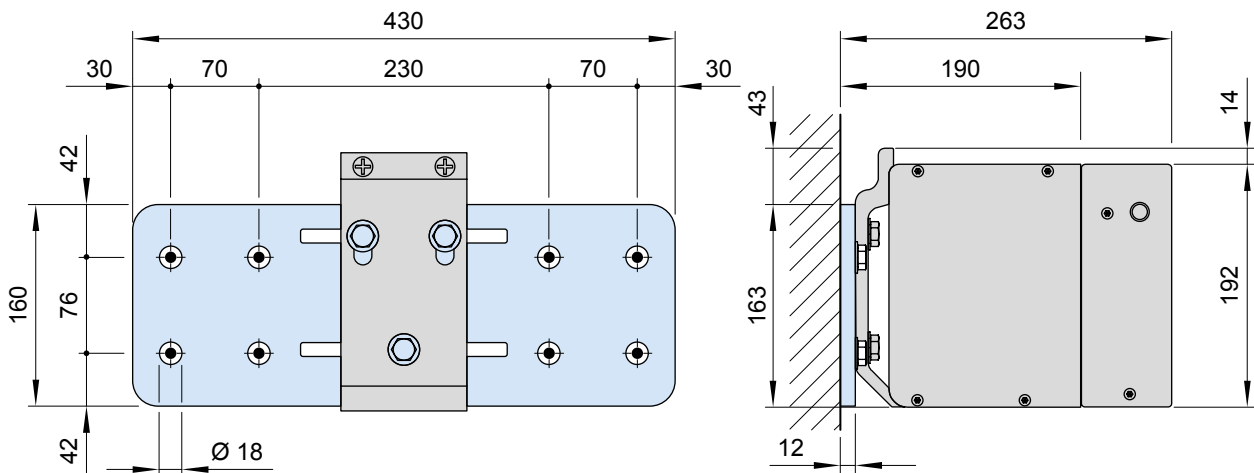

In the case of face fixture using spreader plate A, the rubber sealing strip can only be used in combination with the spacing profile (751971).

dimensions in mm

Face fixture with spreader plate B

Fixtures, fittings and accessories

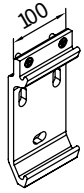

face fixture bracket
100 mm

71994.

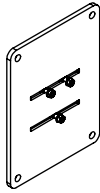

spreader plate B
face fixture
300 × 400 × 12 mm

75323.

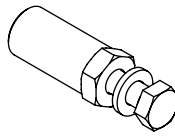

bolt reduction assembly
pack 10 pcs

M 16 → M 12 | M 16 → M 10 | M 12 → M 10 | M 10 → M 10

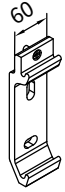

face fixture bracket
60 mm

71995.



spacer plate for face
fixture
60 × 140 × 12 mm

71642.

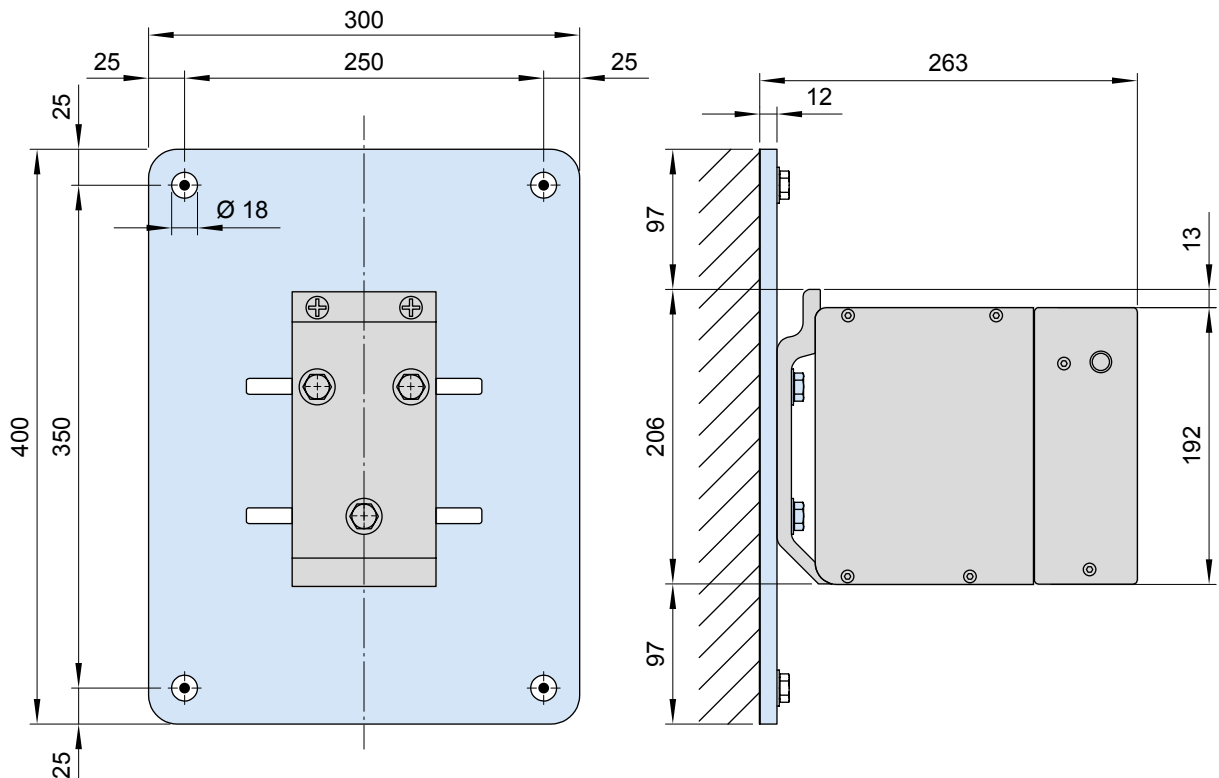

In the case of face fixture using spreader plate A, the rubber sealing strip can only be used in combination with the spacing profile (751971).

dimensions in mm

01
02
03
04
05
06
07
08
09
10
11
12
13
14
15
16
17

01 **Face fixture with markilux panel 250 mm**

02 Fixtures, fittings and accessories

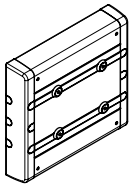

04 markilux panel 250 mm
Befestigungsschiene
mit Abdeckungen und
Seitenkappen
250 × 230 × 49 mm

05 **76308.**

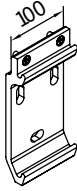

face fixture bracket
100 mm

71994.

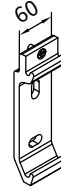

face fixture bracket
60 mm

71995.

07

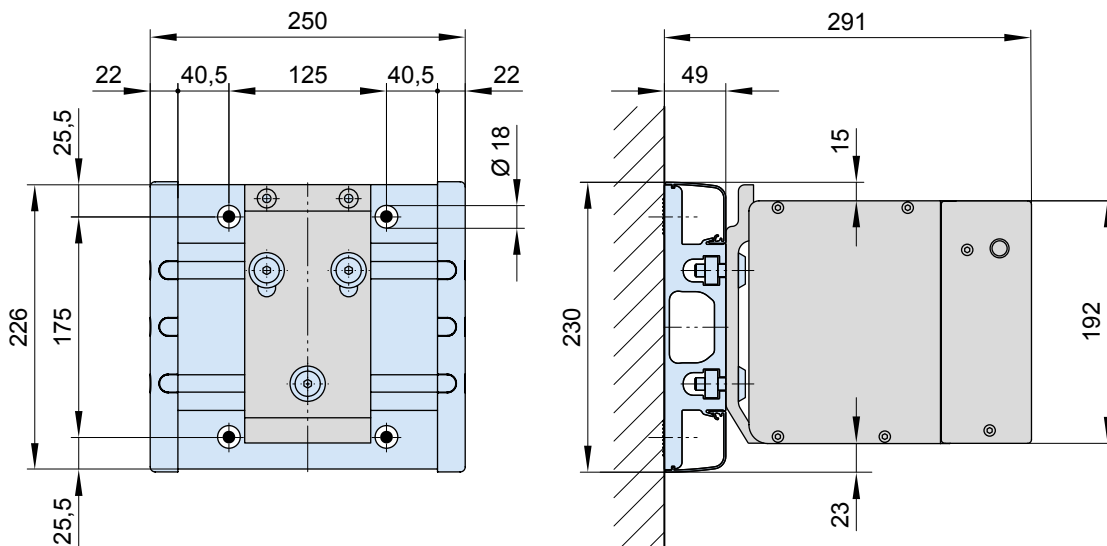

dimensions in mm

Face fixture with markilux panel continuous

Fixtures, fittings and accessories

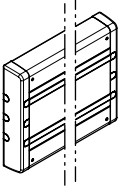

markilux panel fixture profile,
wide with cover profiles and end caps
continuous

76380.

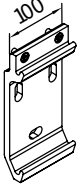

face fixture bracket
100 mm

71994.

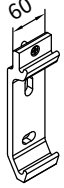

face fixture bracket
60 mm

71995.



Wall sealing profile incl. brush seal when installing with a coverboard
available by the metre

76385. and 704241



1 side plate including 2 pan-head self-tapping screws for wall sealing profile

76386. and 2 x 735611

As a **continuous fixture profile**, the markilux panel will always be supplied to order on the basis of a technical drawing prepared in the factory in accordance with the awning specification.

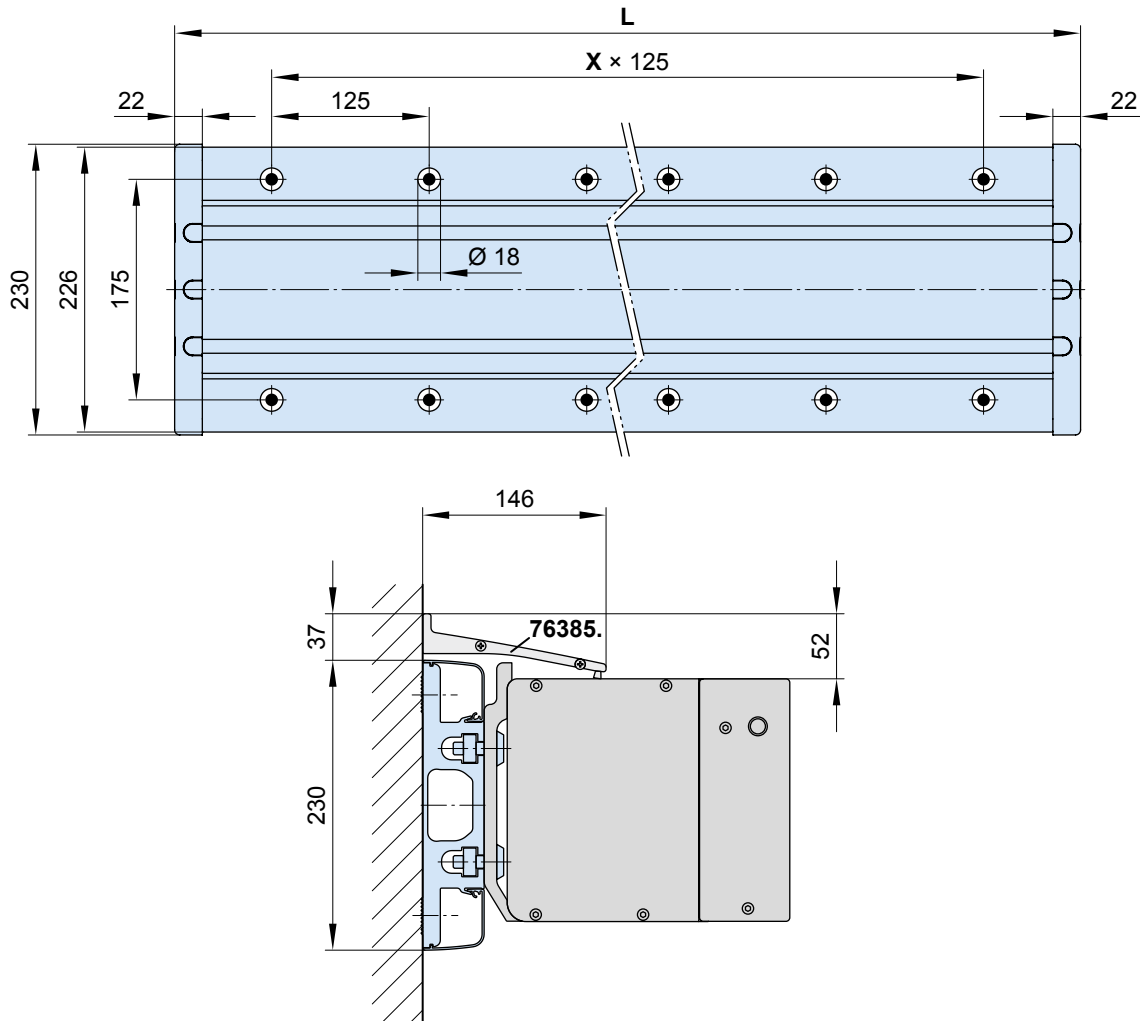

76385. = wall sealing profile (standard width = awning width (M))

L = individual width, max. 7000 mm

X = fixing point separation, **by way of example**

dimensions in mm

Face fixture with stand-off bracket

Fixtures, fittings and accessories

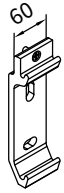

face fixture bracket
60 mm

71995.

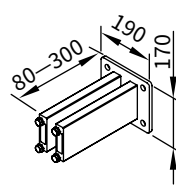

guide rod bracket
for 2 face fixture brackets
71995.

77968.

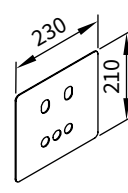

cover plate
for spacer plate
and stand-off brackets
in the case of external
insulation

230 × 210 × 2 mm

71843.

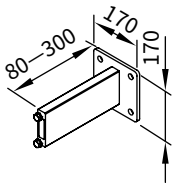

guide rod bracket
for face fixture bracket
71995.

77967.

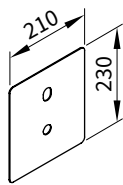

cover plate
for spacer plate
and stand-off brackets
in the case of external
insulation

210 × 230 × 2 mm

71844.

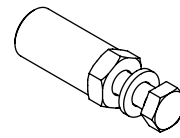

bolt reduction assembly
pack 10 pcs

M 16 → M 12 | M 16 → M 10 | M 12 → M 10 | M 10 → M 10

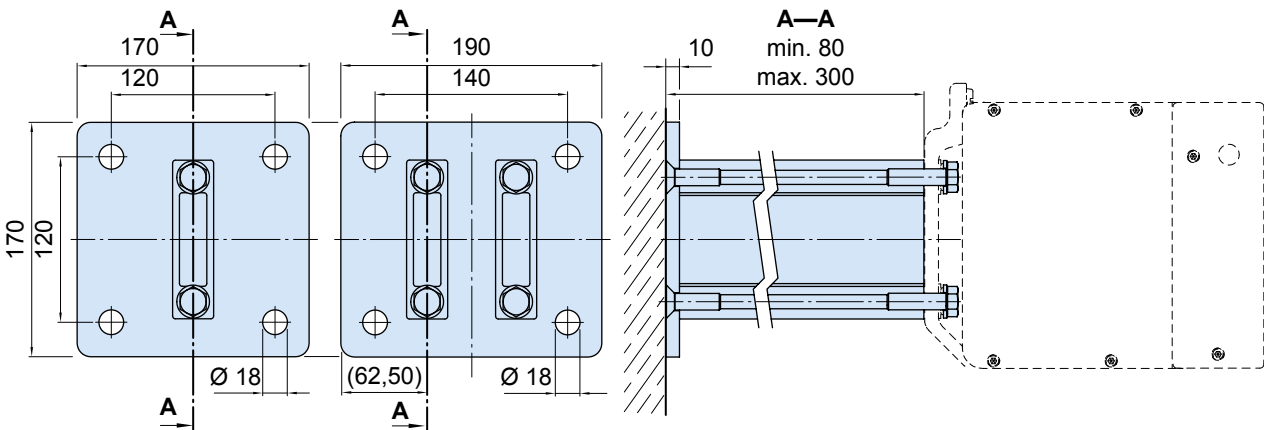
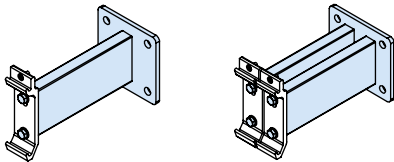

dimensions in mm

Top fixture

Fixtures, fittings and accessories

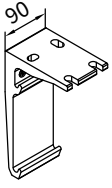

top fixture bracket
90 mm

71651.

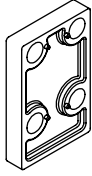

spacer plate for top fixture
90 x 140 x 20 mm

N.B!
stack to a max. height of 200 mm

716311

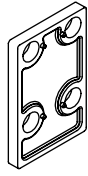

spacer plate for top fixture
90 x 140 x 12 mm

716411

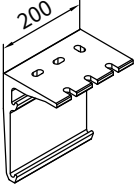

top fixture bracket
200 mm

71652.

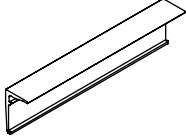

top fixture bracket profile
by the metre, undrilled

701635

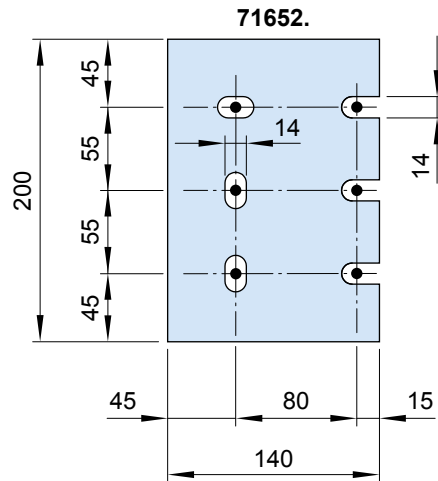
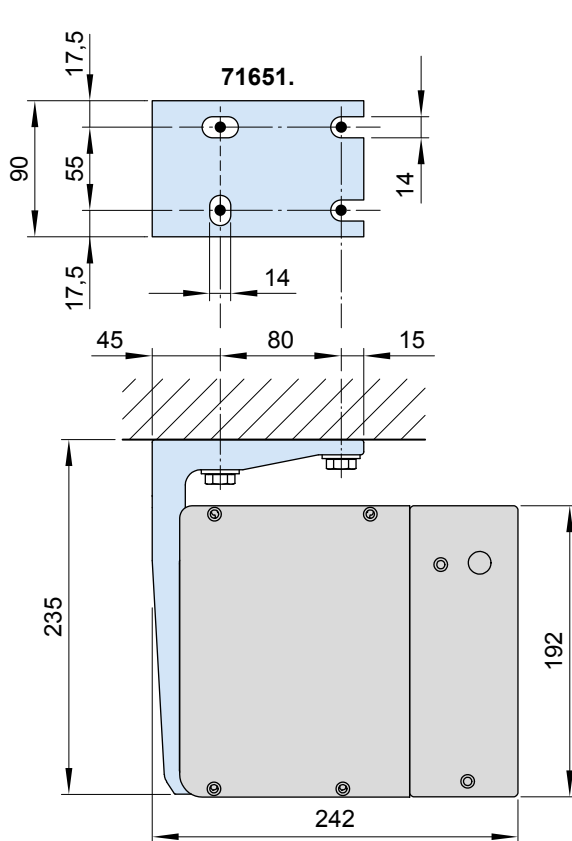

dimensions in mm

01
02
03
04
05
06
07
08
09
10
11
12
13
14
15
16
17

01 **Eaves fixture**

Fixtures, fittings and accessories

02
03
04
05

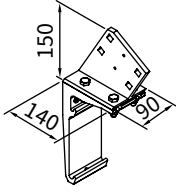

eaves fixture bracket
90 mm

71898.

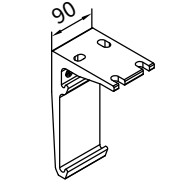

top fixture bracket
90 mm

71651.

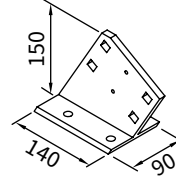

eaves fixture bracket
150 mm plate

71612.

06
07
08
09

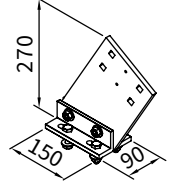

eaves fixture bracket
270 mm

71659.

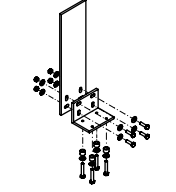

flat plate and angled
bracket for
eaves fixture
machine finish

716620

With eaves fixture bracket 150 mm (71612.)

With eaves fixture bracket 270 mm (71659.)

10
11
12
13
14
15
16
17

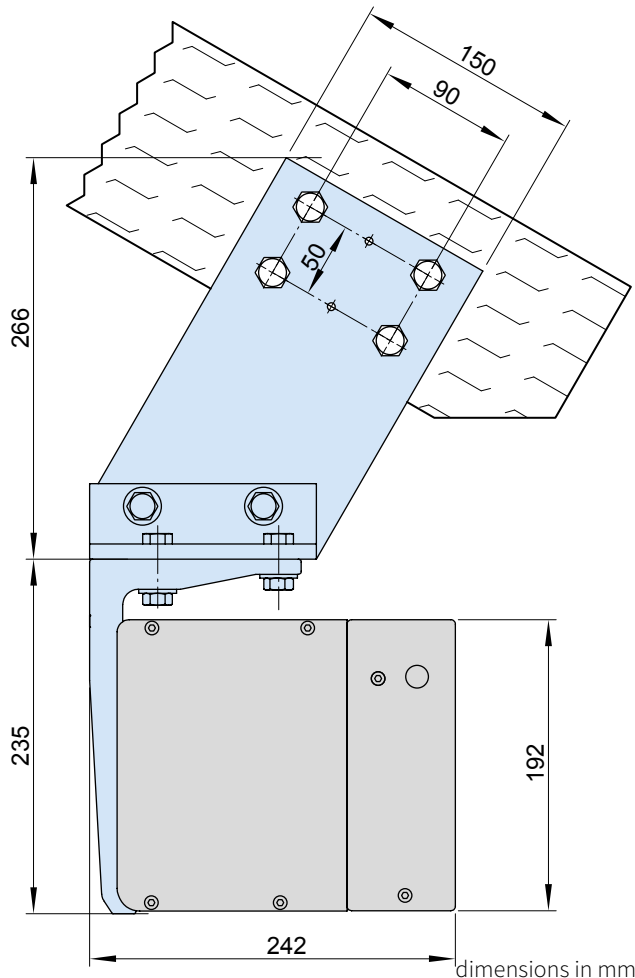
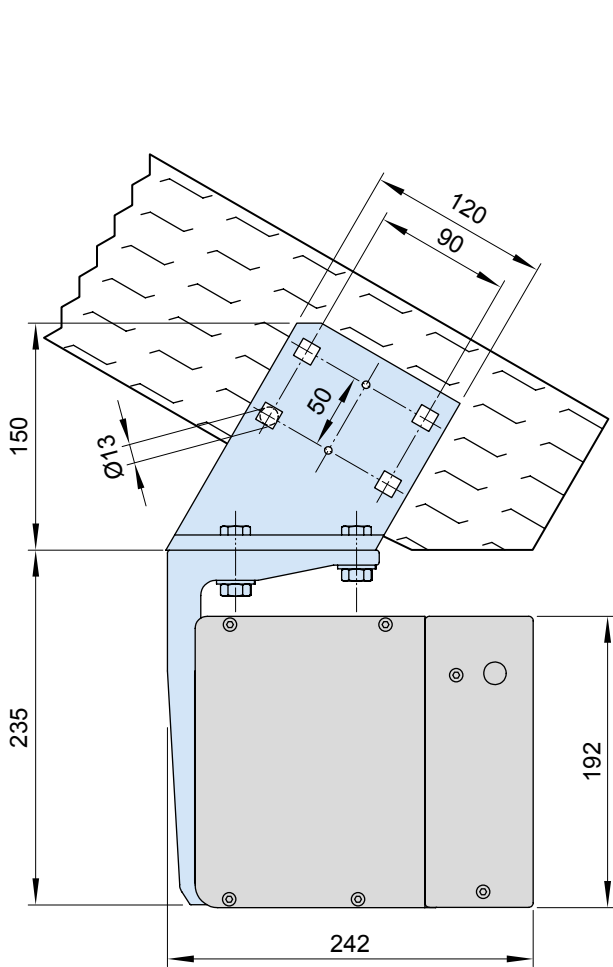

dimensions in mm

Eaves fixture with additional plate

Fixtures, fittings and accessories

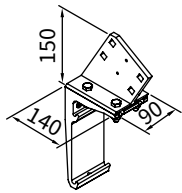

eaves fixture bracket
90 mm

71898.

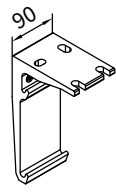

top fixture bracket
90 mm

71651.

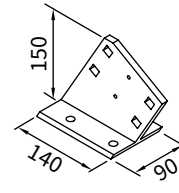

eaves fixture bracket
150 mm plate

71612.

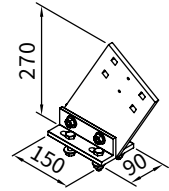

eaves fixture bracket
270 mm

71659.

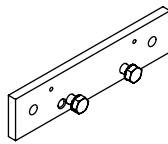

supplementary flat plate
eaves fixture
260 x 60 x 12 mm

75383.

With eaves fixture bracket 150 mm (71612.)

With eaves fixture bracket 270 mm (71659.)

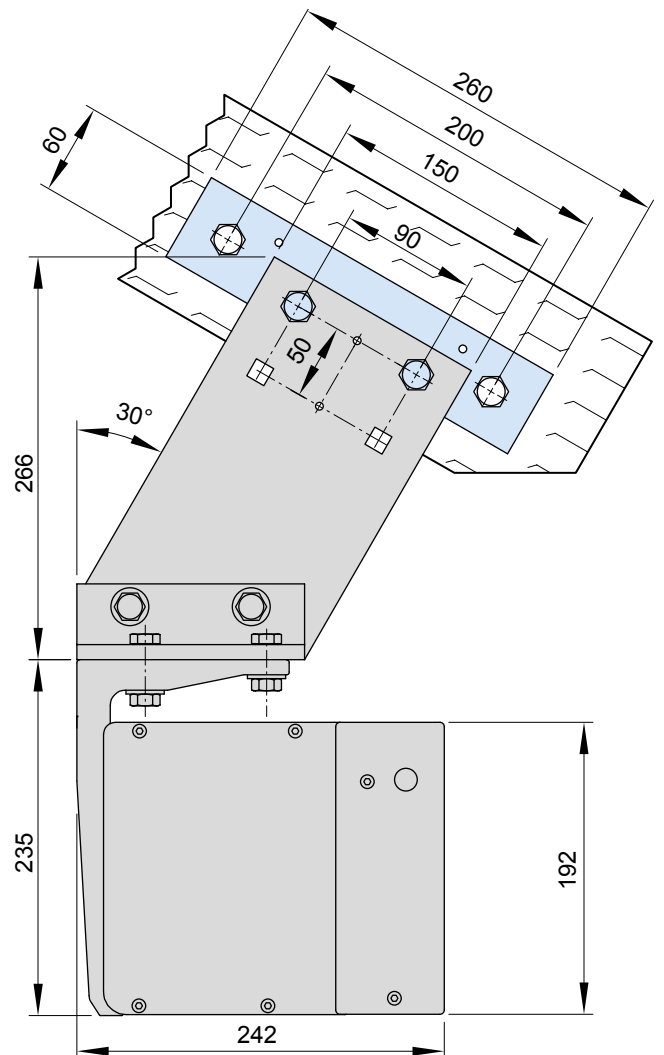
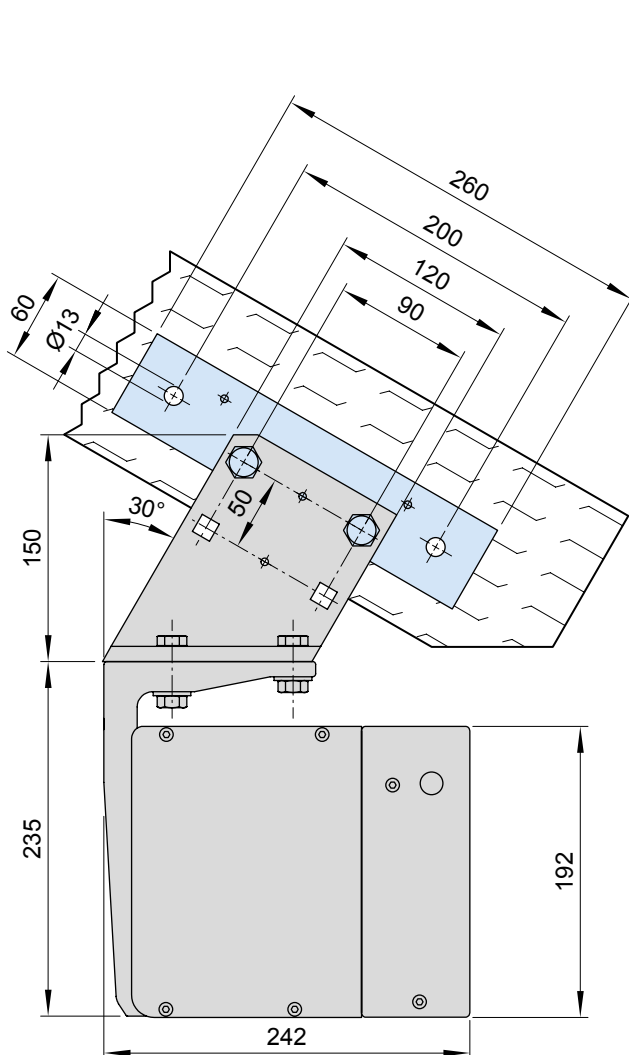

dimensions in mm

01
02
03
04
05
06
07
08
09
10
11
12
13
14
15
16
17

01 **Face fixture, manual operation**

Side view

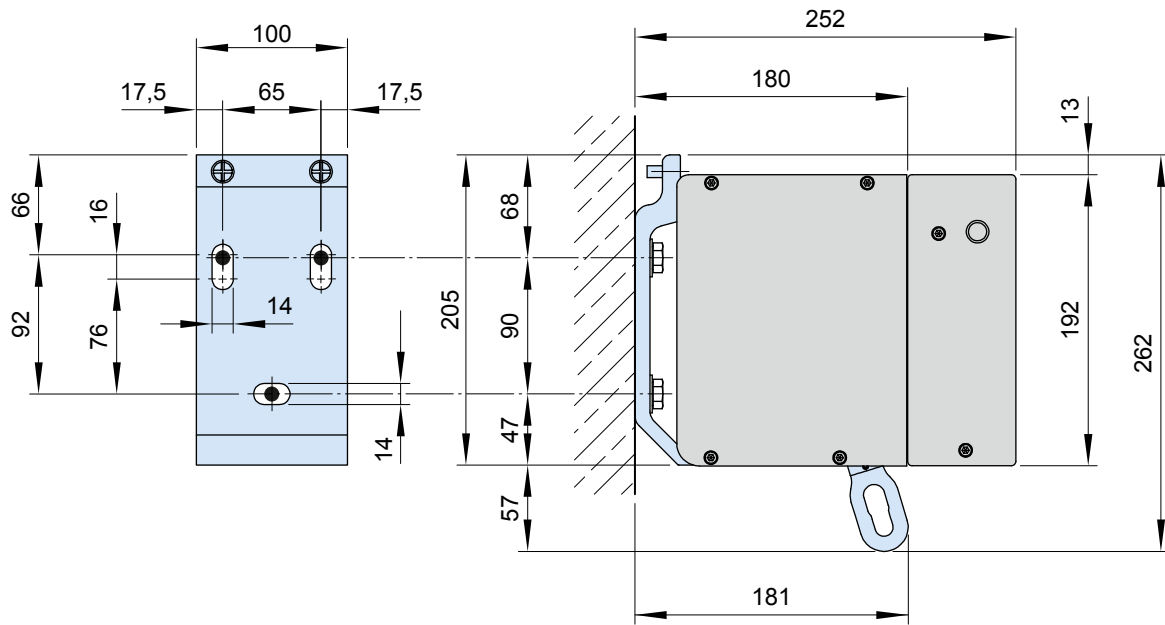

Front view

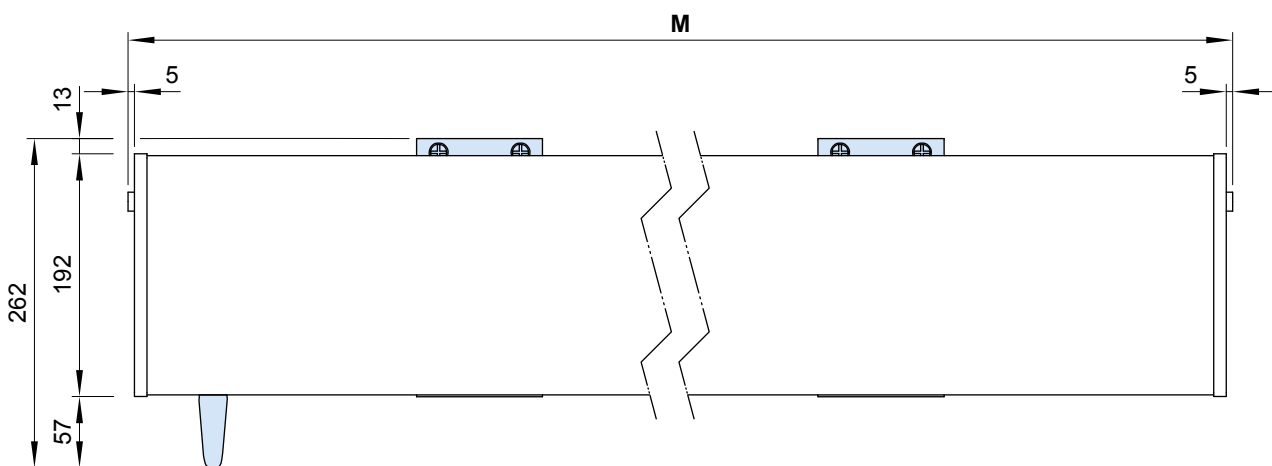

dimensions in mm

Reveal fixture

Front profile slightly open

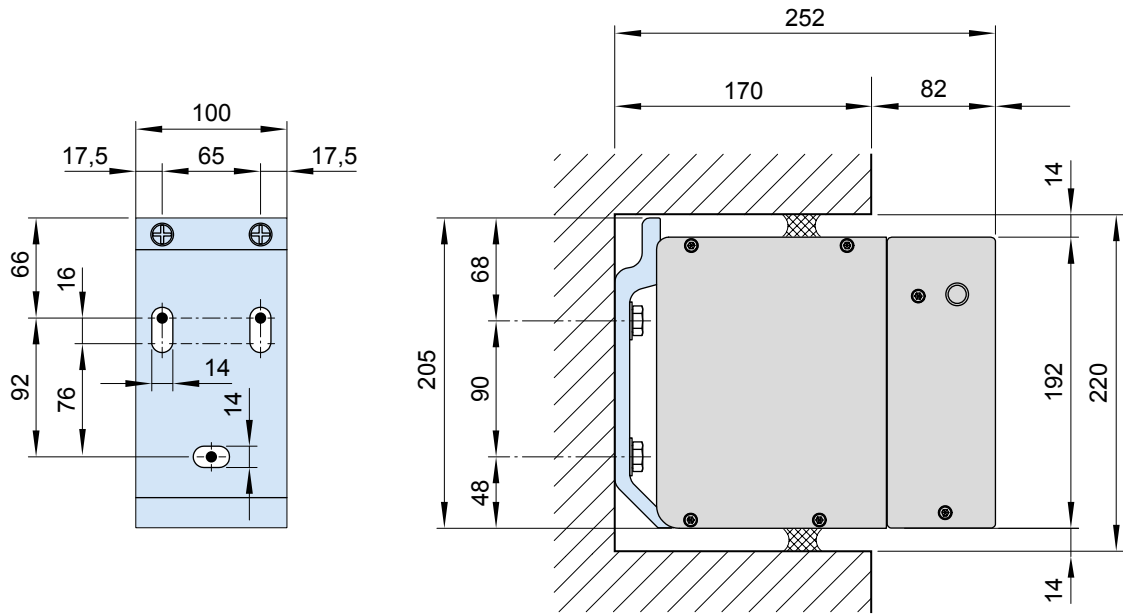

Front profile flush

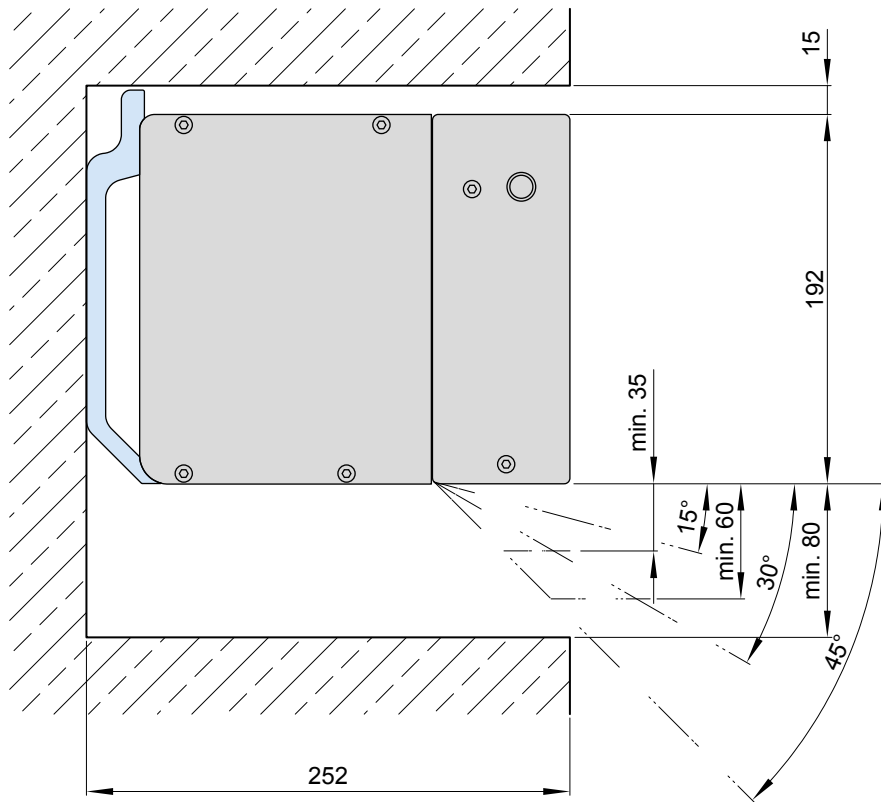

dimensions in mm

01 Motor cable exit point

02

03

04

05

06

07

08

09

10

11

12

13

14

15

16

17

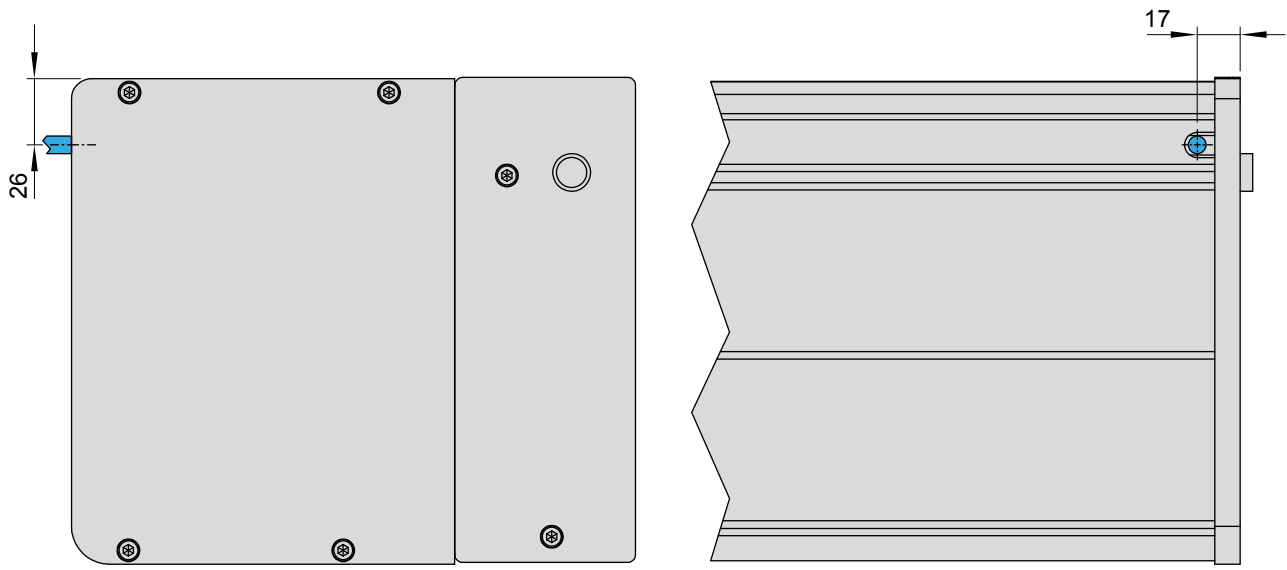

dimensions in mm

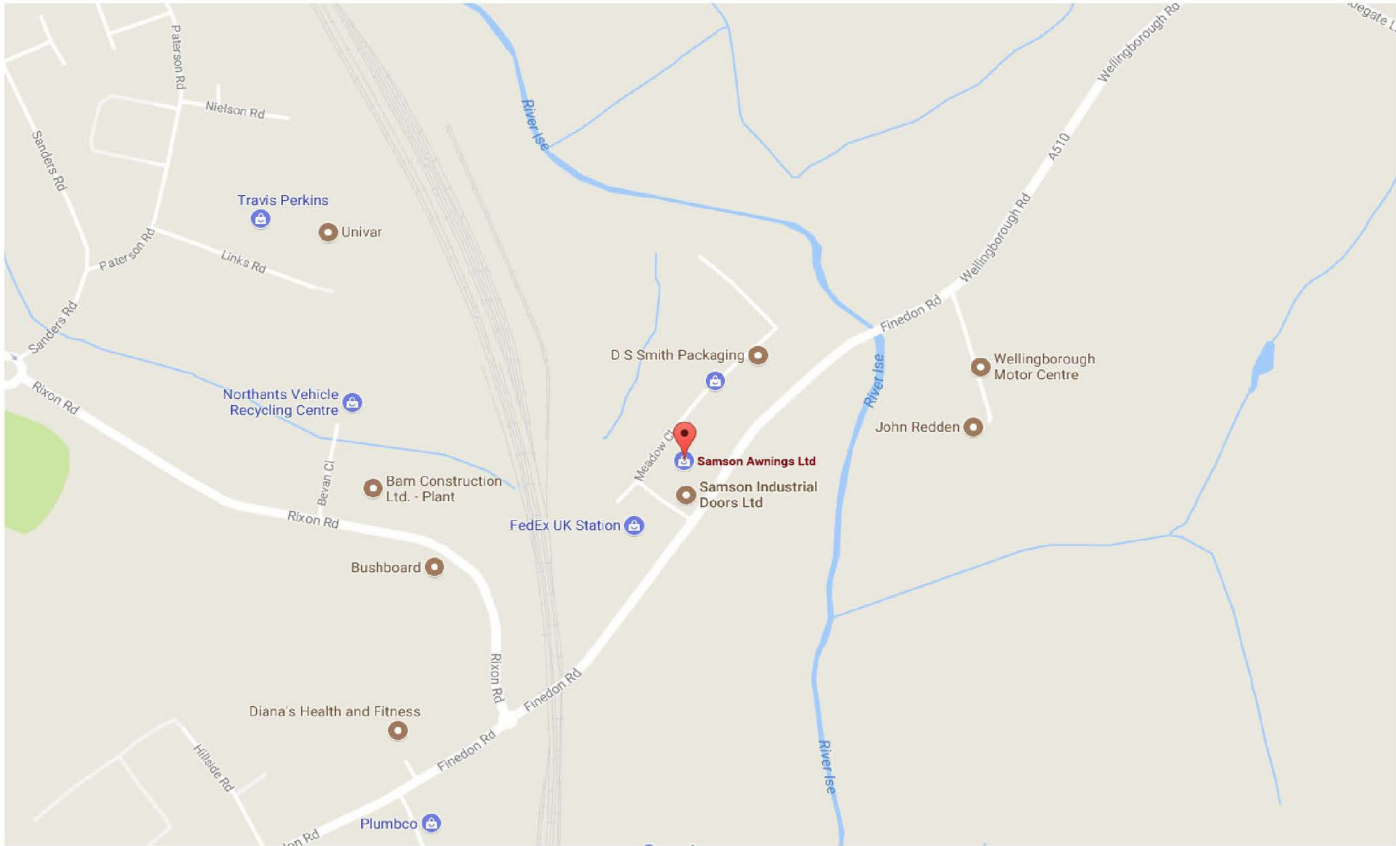

Nationwide delivery and installation service

**6-8 MEADOW CLOSE
ISE VALLEY INDUSTRIAL ESTATE
FINEDON ROAD
WELLINGBOROUGH
NN8 4BH**

**EMAIL: ENQUIRIES@SAMSONAWNINGS.CO.UK
TELEPHONE: (01933) 448844
MON - FRI 8:30AM - 5:30PM**

