

# Hormann Sports Hall Doors



EMAIL: [ENQUIRIES@SAMSONDOORS.CO.UK](mailto:ENQUIRIES@SAMSONDOORS.CO.UK)  
TELEPHONE: (01933) 274276  
MON - FRI - 8.30AM - 5.30PM



# Sports Hall Doors

**NEW:** Doors with elastic impact surface

**NEW:** Fitting behind the lintel for additional clear passage height



# Hörmann Sports Hall Door SP 500

Fit for all sorts of indoor sports



Sports hall doors form the division between halls and equipment rooms in sports and multi-purpose halls. The Hörmann sports hall door complies with the accident prevention regulations for “Schools” of the statutory accident insurance GUV-V S1. The door leaf has been tested as bounce-resistant according to DIN 18032-3. As Europe’s leading manufacturer of doors, hinged doors, frames and operators, we are committed to high product and service quality. This is how we set standards on an international scale.



# Technically Sophisticated

## Operating comfort with the highest security

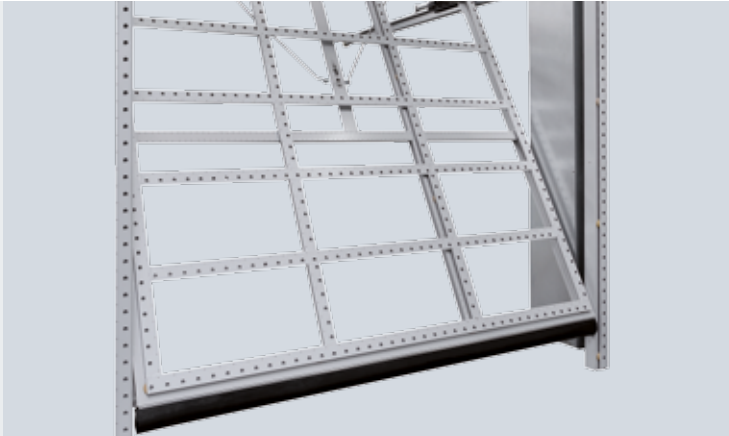

### Safe and space-saving door travel

Vertical and horizontal guide rails ensure safe door guidance and buffer stops slow the door down gently when opening and closing. The door does not swing out when opening, nor does it protrude into the hall when it is opened.

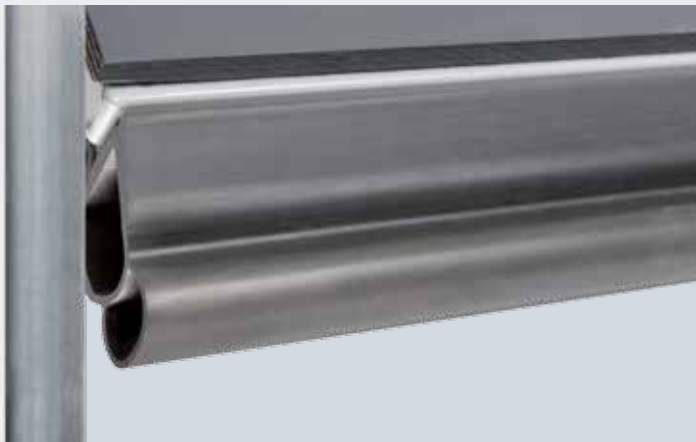

### Elastic foot trap protection

In order to reduce the risk of foot injuries, the bottom edge of the door has been equipped with an elastic trap protection over the entire door width.



### Completely encased counter weights

Protective boxes completely safeguard the counter weights on both sides against reaching in. The door opens and closes effortlessly with the two counter weights. The door is also gently "slowed down" thanks to buffer stops. Double pull cords protect the door leaf from falling.



### Safety track cladding

Adjustable plastic rollers on ball-bearings reduce the wear and ensure longer periods of use. The track cladding is shock-resistant.

# Technology for Maximum Security and a Longer Service Life

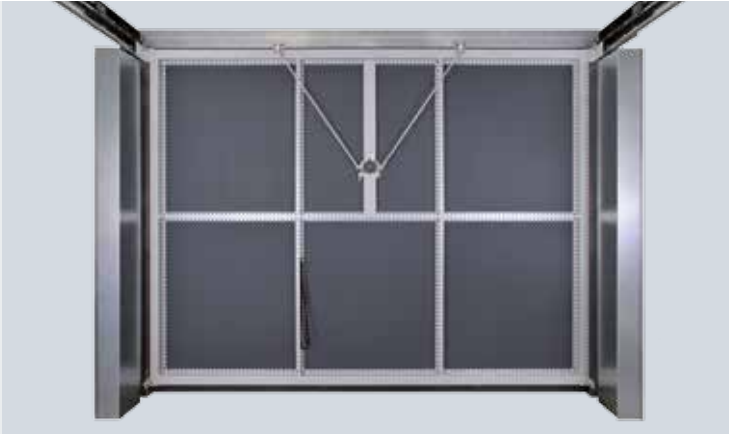

## Sturdy design

Sturdy rectangular tubes with horizontal reinforcement struts ensure long-term functional safety as well as extremely quiet operation.



## Latch lock on both sides

The door is locked by self-engaging upper latch locks. This prevents unintentional opening of the door.



## Star-shaped interior handle

The ergonomic door handle that fits optimally in the palm of the hand, as well as locking rods are found on the equipment room side.



## Injury-proof recessed handle

The recessed handle, optionally in stainless steel, is embedded in the door leaf. This reduces the risk of injury.

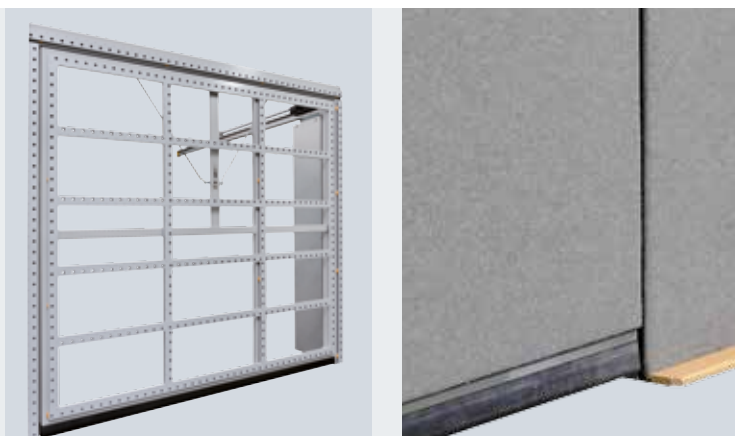

#### Ready-to-fit for on-site infill

The Hörmann sports hall door is optimally prepared for on-site infill. See the tables on page 6 for the max. infill weight. You have the option of hiding the door almost completely in the wall.



#### Elastic impact surface

For the SP 500, a sub-construction is available for an elastic impact surface. This sub-construction provides a force reduction of more than 60 %.



#### Colours and surface finishes

The galvanized frame profiles feature a powder-coated primer in White aluminium based on RAL 9006 as standard. On request, all other RAL colours are also available.



#### Products for sports and multi-purpose halls

In addition to sports hall doors, Hörmann offers you other construction components for your sports hall, such as visibility glazing as control room windows or fire and smoke protection elements in a sheet steel or tubular frame version.

# Technical Data

## Sports hall door SP 500 for surface-mounted on-site infill

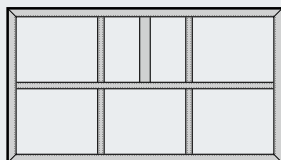

BR width 1500 mm – 3995 mm

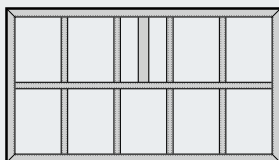

BR width ≥ 4000 mm

- BR height up to 2595 mm: 1 horizontal strut
- BR height from 2600 to 2750 mm: 2 horizontal struts
- BR width up to 1495 mm: No vertical struts
- BR width from 1500 to 3995 mm: 2 vertical struts
- BR width from 4000 to 5000 mm: 4 vertical struts
- BR width from 4500 mm: Bottom profile reinforcement 60 × 40 mm

**Note:**  
For doors with an ordering size BRH less than 2300 mm, the min. clear passage height of 2200 mm required acc. to DIN 18032 cannot be maintained!

		Maximum infill weights in kg/m <sup>2</sup>															
BRH	2750	36	30	26	22	20	18	16	14	12	12	10	8	7	6	6	
	2625	36	32	28	24	20	18	16	14	14	12	10	8	8	7	6	
	2500	36	36	30	26	24	20	18	16	16	14	12	10	10	8	7	
	2375	36	36	32	28	24	22	20	18	16	14	14	12	10	9	8	
	2250	36	36	36	30	26	24	22	20	18	16	14	12	12	10	8	
	2125	36	36	36	32	28	26	22	20	18	18	16	14	12	10	8	
	2000	36	36	36	36	30	28	24	22	20	18	18	14	14	12	10	
		1200	1500	1750	2000	2250	2500	2750	3000	3250	3500	3750	4000	4250	4500	4750	5000
		BRB															

## Sports hall door SP 500 for surface-mounted on-site infill with sub-construction for elastic impact surface

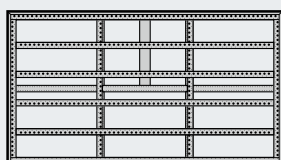

BR width 1500 – 3995 mm

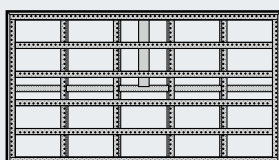

BR width ≥ 4000 mm

- BR height up to 2595 mm: 1 horizontal strut
- BR height from 2600 to 2750 mm: 2 horizontal struts
- BR width up to 1495 mm: No vertical struts
- BR width from 1500 to 3995 mm: 2 vertical struts
- BR width from 4000 to 5000 mm: 4 vertical struts
- BR width from 4500 mm: Bottom profile reinforcement 60 × 40 mm

**Note:**  
For doors with an ordering size BRH less than 2300 mm, the min. clear passage height of 2200 mm required acc. to DIN 18032 cannot be maintained!

		Maximum infill weights in kg/m <sup>2</sup>															
BRH	2750	32	26	20	18	16	14	12	10	8	8	6					
	2625	34	28	22	18	16	14	12	10	10	8	8					
	2500	36	30	26	22	18	16	14	12	10	10	8	6	6			
	2375	36	32	26	24	20	18	16	14	12	10	10	8	6			
	2250	36	34	30	26	22	18	16	14	12	12	10	8	8	6	6	
	2125	36	36	32	28	24	20	18	16	14	12	12	8	8	6	6	
	2000	36	36	34	30	26	22	20	18	16	14	12	10	10	8	6	
		1200	1500	1750	2000	2250	2500	2750	3000	3250	3500	3750	4000	4250	4500	4750	5000
		BRB															

**Attention:**  
The design of the impact surface sub-construction depends on the infill and must be technically clarified before order processing!

**Fitting in the opening (standard)**

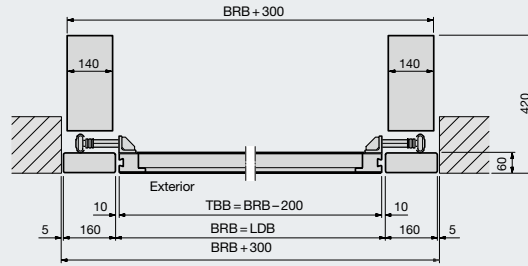
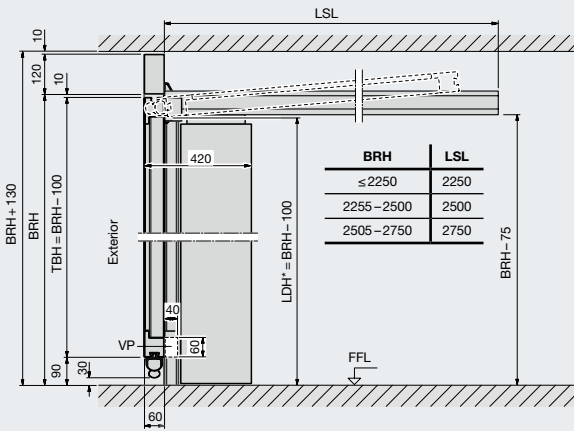

**Fitting in the opening with sub-construction for elastic impact surface**

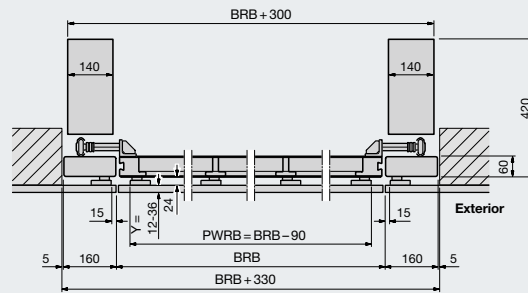
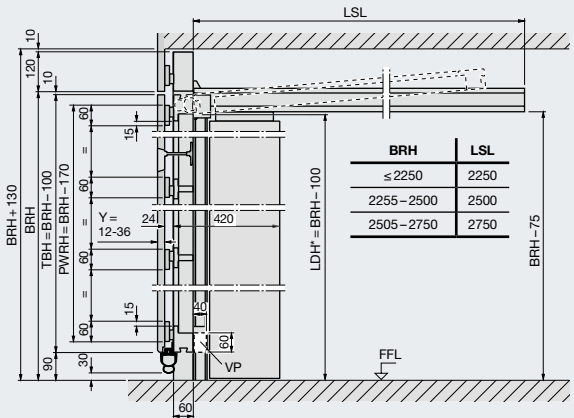

**Fitting in the opening with fitting behind the lintel**

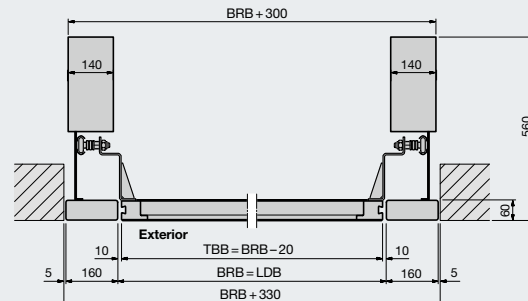
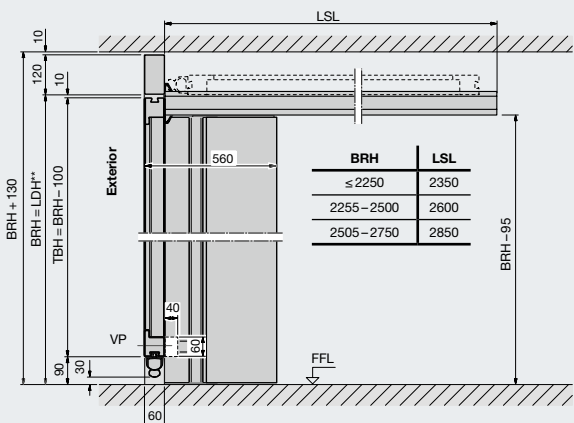

**Explanations**

BRH	TBH	LDH	PWRH	LSL
Nominal size height	Door leaf height	Clear passage height	Impact surface frame height	Track length
BRB	TBB	LDB	PWRB	VP
Nominal size width	Door leaf width	Clear passage width	Impact surface frame width	Reinforcement profile from BRB ≥ 4500
				Y
				Thickness of surface-mounted infill

\* LDH with VP = BRH - 140

\*\* LDH with VP = BRH - 40



# Samson

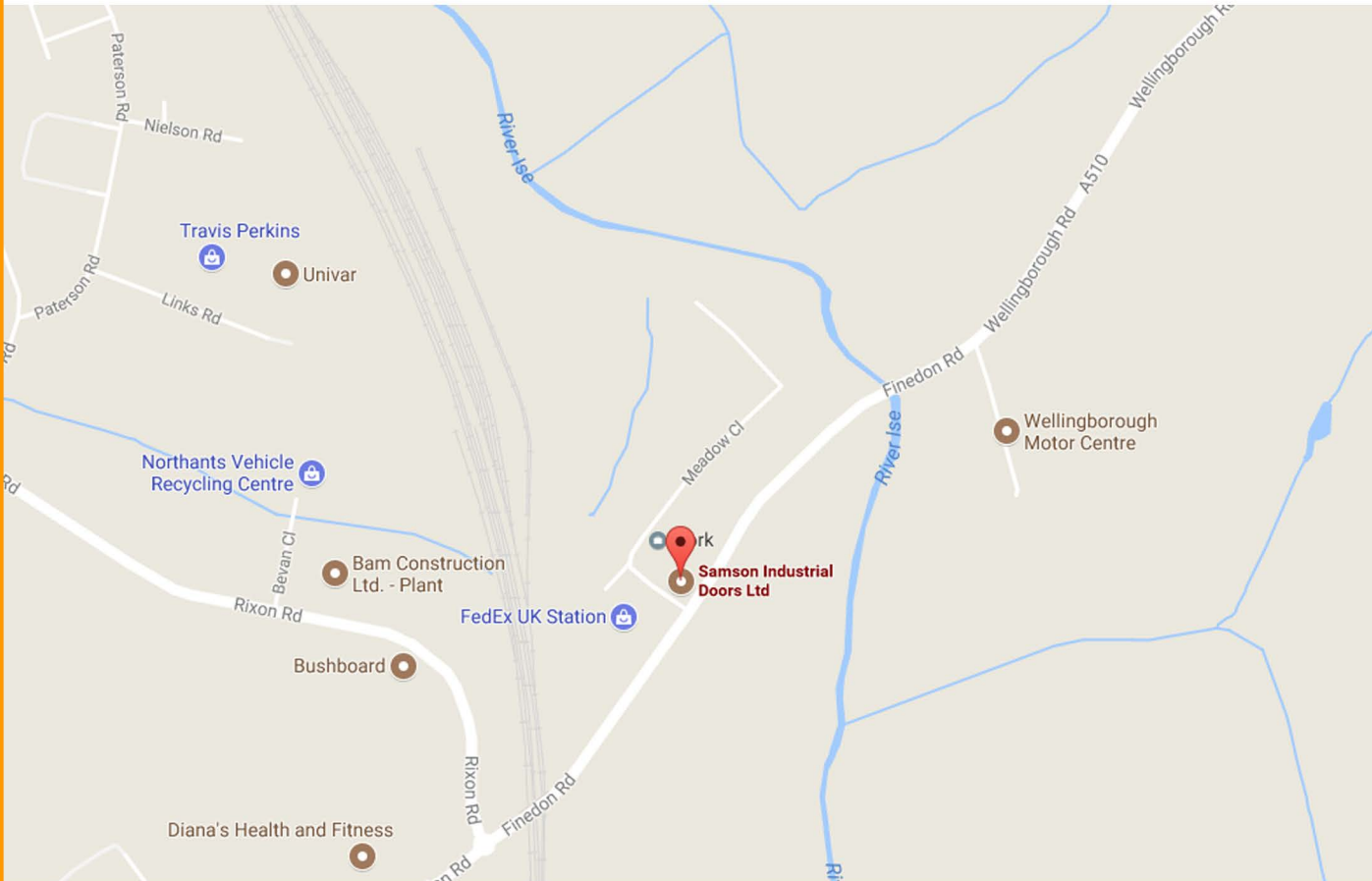

**6-8 MEADOW CLOSE  
ISE VALLEY INDUSTRIAL ESTATE  
FINEDON ROAD  
WELLINGBOROUGH  
NN8 4BH**

**EMAIL: [ENQUIRIES@SAMSONDOORS.CO.UK](mailto:ENQUIRIES@SAMSONDOORS.CO.UK)  
TELEPHONE: (01933) 274276  
MON - FRI - 8.30AM - 5.30PM**

**SAMSON**

