

## **SWS SeceuroDoor Brochure**



**EMAIL: [ENQUIRIES@SAMSONDOORS.CO.UK](mailto:ENQUIRIES@SAMSONDOORS.CO.UK)  
TELEPHONE: (01933) 448850  
MON - FRI 8:00AM - 5:00PM**

SeceuroDoor  
Industrial Doors



Built for Business.  
Engineered for Security  
Steel Shutters  
& Industrial Doors



# Welcome to the SeceuroDoor Range of Steel Tubular Shutters & Industrial Doors

SWS UK products have been protecting properties since 1985.

SeceuroDoor is the perfect choice when strength and durability matter most. Offering a robust alternative to aluminium shutters, they combine exceptional security with the flexibility to suit a wide range of industrial and commercial applications.

#### The Complete Solution

With SeceuroDoor, you don't just choose a door – you choose peace of mind. Whether securing a busy loading bay, protecting valuable stock or enhancing your premises with a clean, professional finish, SeceuroDoor delivers uncompromising performance every time.

#### All SeceuroDoor products are:

- ✓ Proudly manufactured in the UK
- ✓ Made to measure for a tailor-made solution
- ✓ CE or UKCA marked - ensuring 100% compliance
- ✓ Insurance and police approved products available
- ✓ ISO9001 quality certified
- ✓ Performance tested for long-term durability





## Why Choose SeceuroDoor?

- Available in single skin and insulated profiles
- Wide range of industrial motors, including trusted brands like GfA
- Quality tubular motors suitable for lower usage applications including Somfy automation
- Manually operated chain- or spring-operated doors
- Custom finishes, colours and vision options to suit every building design
- Online configurator quick and accurate ordering and technical drawings
- Dual manufacturing sites in Lancaster and London
- Rapid and reliable lead times on full and part products
- Nationwide delivery fleet with site deliveries available
- Express parts ordering for emergency repairs

### Fitter-Friendly Design

- Universal, laser-cut, folded end plates for greater strength
- Pre-slotted angles for easy on-site adjustments
- Predrilled guide channels with low profile bolts
- Deburred door edges for easier (and safer) fitting



# SeceuroDoor Product Matrix

		Page	Overall Maximum Sizes (mm)	Slats		Motors				Insurance Approved
				Single Skin Slat	Insulated Slat	Tubular Motor	Inboard Motor	Direct Drive Motor	Manual	
Tubular	SeceuroDoor Continental 75	8	5800 x 3400	●		●				
	SeceuroDoor Traditional 75 <sup>evo</sup>	8	7000 x 5000	●		●				
	SeceuroDoor 7501	9	6000 x 4800	●		●				●
	SeceuroDoor Traditional 77	9	6000 x 3400		●	●				
		Page	Clear Opening Maximum Sizes (mm)	Single Skin Slat	Insulated Slat	Tube Motor	Inboard Motor	Direct Drive Motor	Manual Option	Insurance Approved
Industrial	SeceuroDoor 75	12	7000 x 7000	●			●	●		
	SeceuroDoor 7502	13	6200 x 4600	●			●	●		●
	SeceuroDoor 77	13	20 m <sup>2</sup> (max width 6000)		●		●	●		
	SeceuroDoor 95	14	44 m <sup>2</sup>		●		●	●		
	SeceuroDoor 9501	15	44 m <sup>2</sup>		●		●	●		●
	SeceuroDoor 100	15	7000 x 7000		●		●	●		
Manual	SeceuroDoor Continental 75 Spring Op	17	4000 x 2800	●					●	
	SeceuroDoor Traditional 75 Spring Op	17	4000 x 2800	●					●	
	SeceuroDoor 7501 Spring Op	18	4000 x 2800	●					●	●
	SeceuroDoor 75 Chain Op	18	5000 x 5000	●					●	
	SeceuroDoor 77c Chain Op	19	5000 x 4000		●				●	

**NEED TO GO BIGGER?**  
Larger sizes may be available.  
Contact us to find out more.





Heat Transmission W/m²K	Wicket Door	Vision	Safety Edge	Sloping Bottom Slat	Standard Colour	Powder Coated	Plastisol
N/A		●	●	●	Galvanised	●	●
N/A	●	●	●	●	Galvanised	●	●
N/A		● (Perf only)			Galvanised	●	●
4.01			●	●	Galvanised	●	
Heat Transmission W/m²K	Wicket Door	Vision	Safety Edge	Sloping Bottom Slat	Standard Colour	Powder Coated	Plastisol
N/A	●	●	●	●	Galvanised	●	●
N/A			●		Galvanised	●	●
4.01			●	●	Galvanised	●	
Centre: 1.1 Quirk: 3.2		●	●		Galvanised	●	●
Centre: 1.1 Quirk: 3.2			●		Galvanised	●	●
Infill piece: 0.553		●	●		Galvanised	●	●
N/A		●		●	Galvanised	●	●
N/A	●	●		●	Galvanised	●	●
N/A		● (Perf only)			Galvanised	●	●
N/A	●	●		●	Galvanised	●	●
4.01					Galvanised	●	

### Secured by Design



Secured by Design is the official UK Police initiative supporting the principles of 'designing out crime' by use of effective crime prevention and security standards for a wide range of products and applications. Only products which have been tested and meet the required technical standard can be awarded the Police Preferred Specification.

### Insurance Approved Security



The rigorous LPS 1175 burglary resistance standard is operated by the Loss Prevention Certification Board (LPCB), the UK's leading independent certification body. The LPS 1175 standard is recognised and endorsed by 16 organisations including the Association of British Insurers and the Association of Chief Police Officers.

**COLOURS & FINISHES**  
See page 27 for important information on colours and finishes.





## SeceuroDoor Tubular Shutters

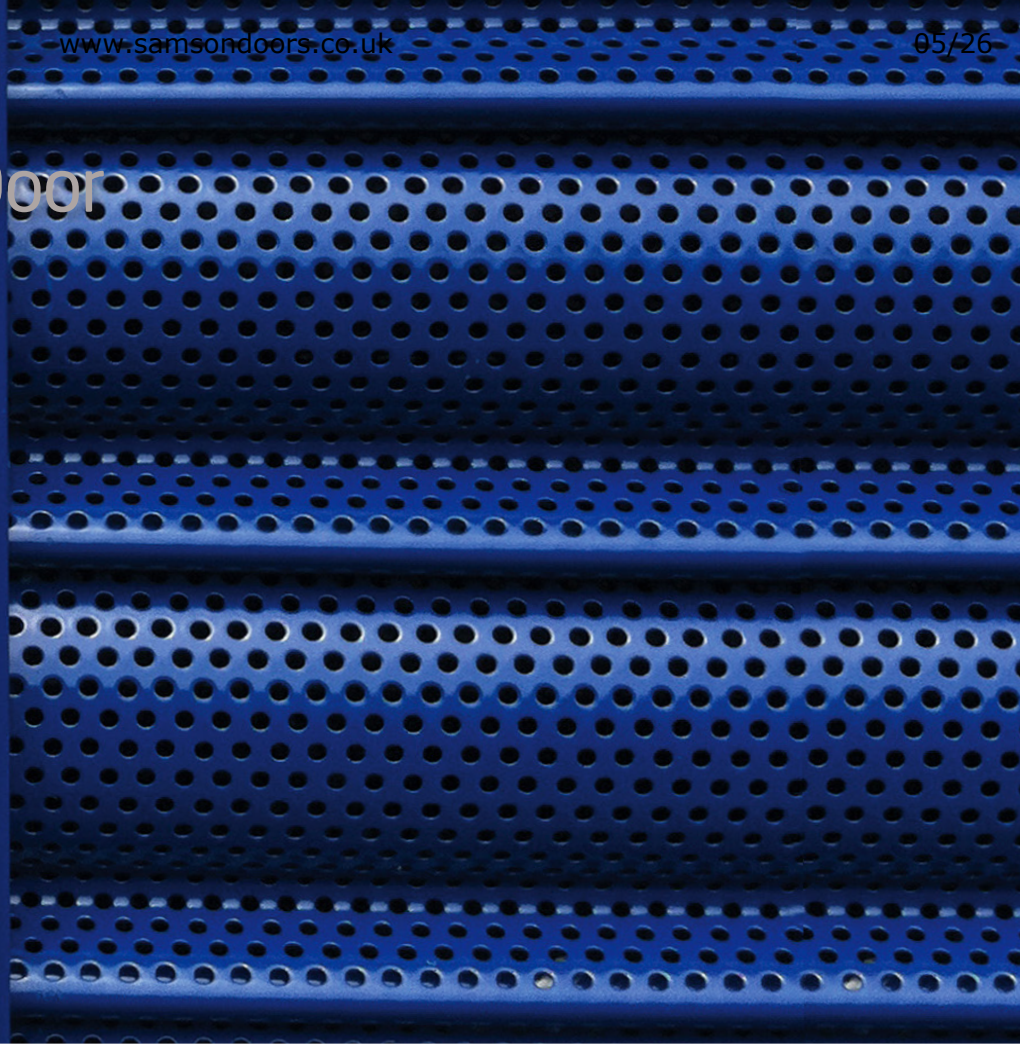

# Tubular Shutters

## It's our Business to Protect Yours

SeceuroDoor Tubular Shutters are powered by strong, reliable tubular motors, designed for lower daily cycles compared to industrial models. Also available with manual spring-operation (see [page 17](#)).

Designed for lower daily cycles compared to industrial models, tubular shutters are suitable for:

- **Retail Units & Shopfronts** Providing protection against burglary and vandalism while offering options for visibility.
- **Commercial Premises** Providing out-of-hours security for bars, gyms and entertainment venues.
- **Garages & Workshops** Protecting vehicles, stock and equipment.
- **Car Parks** Providing controlled vehicle entry and exit combined with robust security.
- **Public Sector Buildings** Securing service entrances, restricted zones and storage areas.

### Traditional Design

Traditional shutter construction employing steel channel and angle guides.

- ✓ Stronger construction, more suitable for larger sizes
- ✓ End plate attached to angle therefore more suitable for shutters where the headplate requires additional support

### Continental Design

A shutter with a neat continental style head box and aluminium guides for higher grade installations. The design facilitates easier installation than traditional shutters.

- ✓ Aluminium guide width 90 mm
- ✓ Neat design



# 25% Faster Fitting The Next *EVO*lution of SeceuroDoor



SeceuroDoor **EVO**  
Traditional Shutter

Now available on the SeceuroDoor 75 Traditional Tubular Shutter, the **new EVO design** delivers enhanced durability and fitter-friendly features.

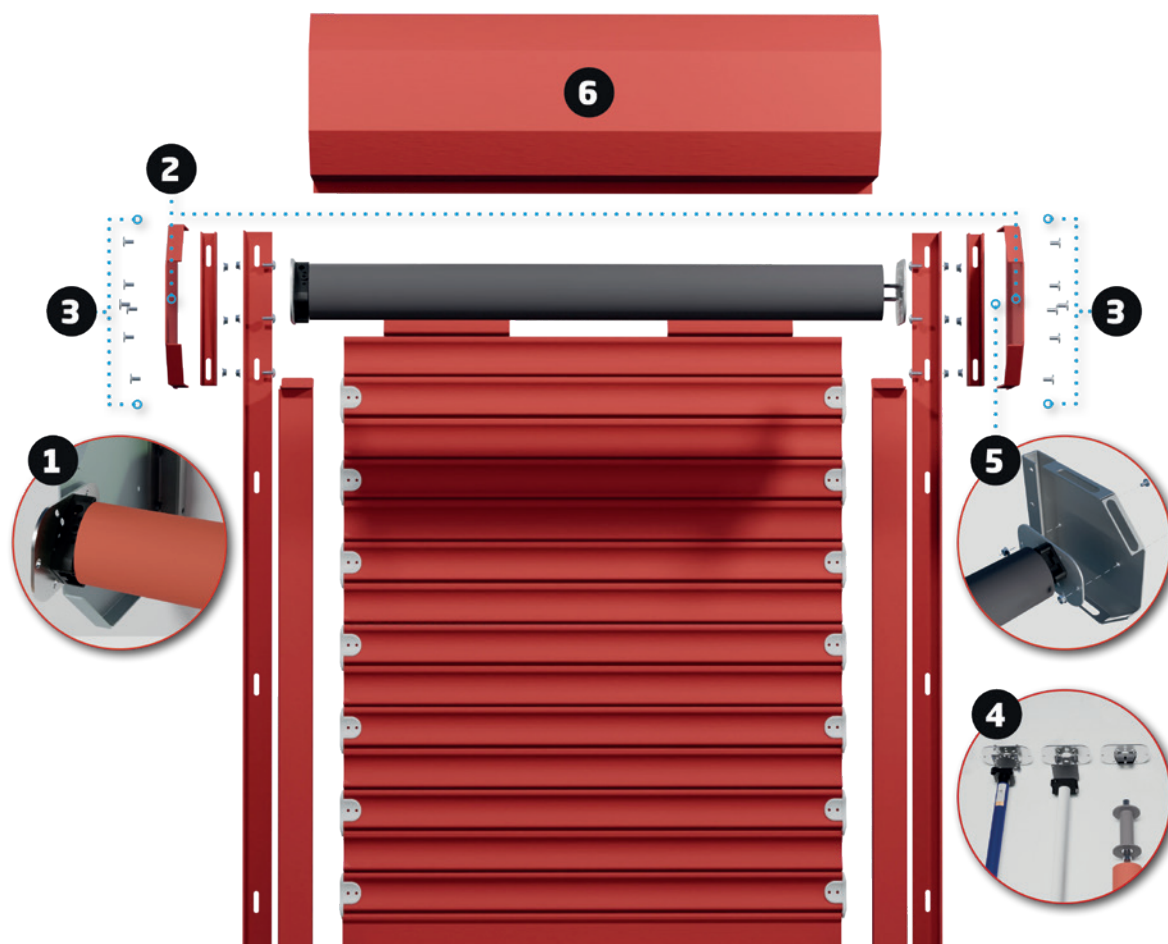

## 1 QUICKER & EASIER INSTALLATIONS

With one-man installs possible on smaller door sizes.

## 2 LASER-CUT UNIVERSAL END PLATES

With no handing, for easier post-survey or on-site adjustments.

## 3 BOLTED END PLATE DESIGN WITH NO WELDING

Keeps the zinc coating intact for superior corrosion protection and durability.

## 4 IMPROVED ADAPTOR PLATES

With two fixing holes for all configurations and easy future motor modifications.

## 5 PRECISION MANUFACTURING

For more accurate alignment, reducing installation time.

## 6 IMPROVED HOOD DESIGN

With increased rigidity and improved protection against water ingress.



### Galvanised Steel Single Skin Continental Tubular Shutter

- Our original commercial shutter
- Strong single skin galvanised steel profile
- Available in 18g (POA), 20g and 22g
- Galvanised steel finish as standard
- Neat powder coated aluminium guides
- Can be powder coated any RAL / BS colour
- Plastisol colours available
- Will reverse coil if required (will increase coil size)
- Also available in manual spring and lock operation (see page 17)
- Max width up to 5800 mm
- Max height up to 3400 mm
- Max area up to 20 m<sup>2</sup>
- Wind class rating: Class 2

#### Vision options

- Available with full or part vision
- Delivers up to 30% vision (when back lit)

### Galvanised Steel Single Skin Traditional Tubular Shutter

- Medium security office / commercial / retail applications
- **New EVO design** for faster fitting and enhanced durability
- Strong single skin galvanised steel profile
- Available in 18g (POA), 20g and 22g
- Galvanised steel finish as standard
- Can be powder coated any RAL / BS colour
- Plastisol colours available
- Will reverse coil if required (will increase coil size)
- Available with 3 or 5 mm fixing angles or 5 mm box section
- Also available in manual spring and lock operation (see page 17)
- Max width up to 7000 mm
- Max height up to 5000 mm
- Max area up to 35 m<sup>2</sup>
- Wind class rating: Class 2 (when used on 65 mm+ guides)

#### Vision options

- Available with full or part vision
- Delivers up to 30% vision (when back lit)

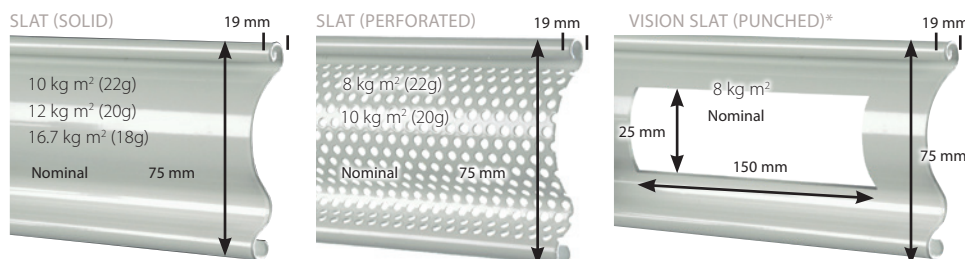

**Punched Curtain**  
150 mm x 25 mm regular punched hole with 50 mm space between. Available in brickbond or in line configuration.

#### BOTTOM RAILS & GUIDE OPTIONS

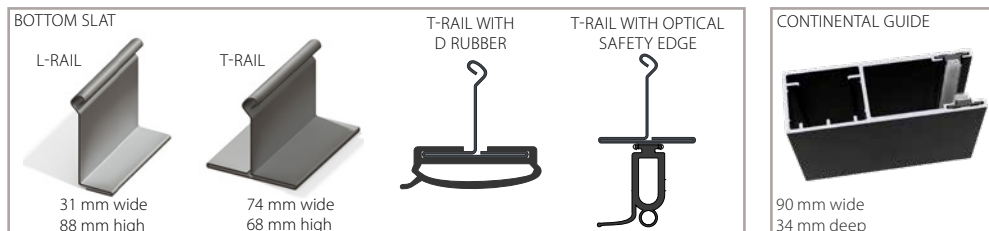

#### STANDARD COLOURS FOR CONTINENTAL BOX & GUIDES

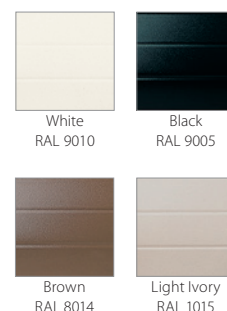

**Please note:**  
Colour references are a guide only and will not match powder coated finish.

#### TRADITIONAL GUIDES

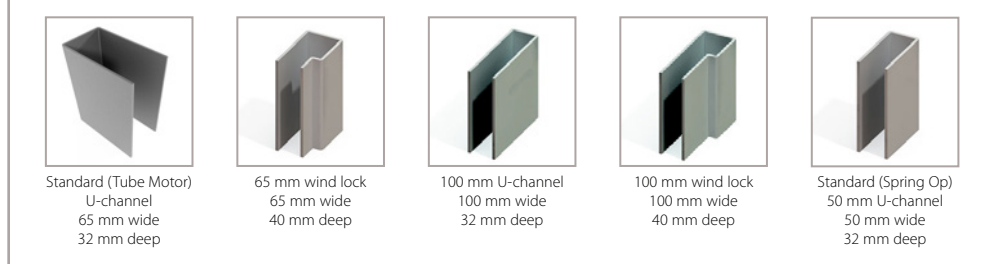

## SeceuroDoor | 7501 Tubular Motor Insurance Approved Security Shutters

### Level 1 Insurance Approved Security Shutters



Single skin shutter with independent testing and approval to LPS 1175. Level 1 security rating and Secured by Design approved. A popular choice for medium use applications where additional security or certification is required.

- Security level 1
- Higher security office / commercial / retail applications
- Strong 22g single skin galvanised steel profile
- Galvanised steel finish as standard
- Traditional or continental design
- Can be powder coated any RAL / BS colour
- Plastisol colours available
- Available solid or with full or partial perforated vision
- Spans widths up to 6000 mm
- Will reverse coil if required (will increase coil size)
- Wind class rating: Class 2

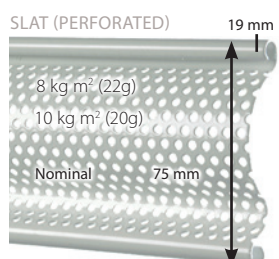

## SeceuroDoor | 77t Tubular Insulated Steel Security Shutter

### Insulated Tubular Shutter

Our insulated commercial shutter combines all the qualities of the robust SeceuroDoor 75 but with the added benefit of insulation. Minimal thermal bridges and the use of fine-pored PU rigid foam infill ensure good thermal insulation whilst curtain and sealing technology used around the entire shutter reduce noise from both inside and outside.

- Medium security commercial applications
- Lath heat transmission performance: 4.01 W/m²K
- Strong insulated galvanised steel profile
- Galvanised steel finish as standard
- Continental aluminium guides with steel box
- Can be powder coated any RAL / BS colour
- Max width up to 6000 mm
- Max height up to 3400 mm
- Max area 20 m²
- Wind class rating: Class 2  
Standard guide angle is 75 mm x 50 mm  
Other sizes are available on request



#### BOTTOM RAIL & GUIDE OPTIONS

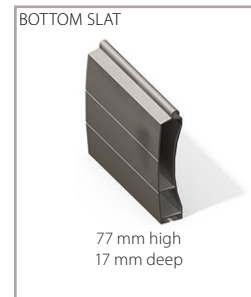
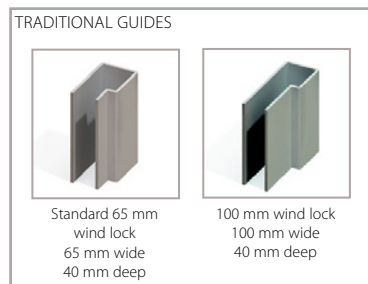



**SeceuroDoor**  
Industrial Doors

# Industrial Doors

Engineered for Industry, Designed for Durability

SeceuroDoor Industrial Doors are powered by high-performance industrial motors, engineered to deliver smooth, reliable and efficient operation in even the busiest commercial and industrial environments.

Available in a choice of single skin or insulated lath profiles, the range offers high-usage and high-speed drive options alongside hundreds of configuration possibilities.

SeceuroDoor Industrial Doors are suitable for:

- **Warehouses & Distribution Centres** Securing loading bays, goods-in/out areas and protecting stock.
- **Factories & Manufacturing Plants** Providing access control while withstanding heavy use and demanding environments.
- **Industrial Units & Workshops** Offering robust security and insulation for tools, equipment and machinery.
- **Agricultural Buildings** Securing barns, storage sheds and other farm structures while protecting equipment, vehicles, and livestock.

## Why Choose SeceuroDoor Industrial?

### Features & Benefits

- Range of industrial motors, available as direct drive, inboard, single phase or 3 phase
- Manual chain-operation available (see [page 18](#))
- Level 1 and 2 security rated doors available
- Universal, laser-cut, folded end plates for greater strength
- Pre-slotted angles for easy on-site adjustments
- Predrilled guide channels with low profile bolts
- Deburred door edges for easier (and safer) fitting
- Welded tabs as standard to correct coning issues and prevent slat jump if the limits are lost
- Predrilled axle & RivNuts, instead of welded nuts or studs, for ease of installation
- Slotted top slat instead of attachment strips for greater flexibility on site



## GfA Extended Warranty



Only SWS UK offers an extended **2-year warranty** on **GfA industrial motors**, when you register each drive using the GfA bluetooth dongle.

Registration is easy and comes with a host of benefits:

- View and track all your registered GfA assets in one place
- Monitor ongoing usage
- Keep track of drive settings over time
- Access a comprehensive library of fault codes
- Synch your service records

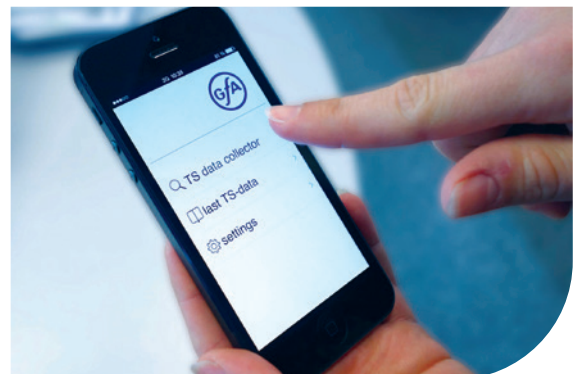



SeceuroDoor 75 Solid  
Green Finish



SeceuroDoor 75 Punched Vision  
Galvanised Finish

**SeceuroDoor | 75**  
Industrial Doors

Single Skin Galvanised Steel  
Industrial Door

- Medium security commercial/industrial applications
- Strong single skin galvanised steel profile
- Available with 18g (POA), 20g or 22g steel slat
- Galvanised steel finish as standard
- Can be powder coated any RAL / BS colour
- Plastisol colours available
- Choice of 4 guide arrangement options
- Standard guide angle is 75 mm x 50 mm
- Other sizes are available on request

**THIS PRODUCT CAN BE POWDER COATED**  
Note: this product will be powder coated after it has been assembled.

**THIS PRODUCT CAN BE PLASTISOL COATED**  
Note: finish applies to the external face of curtain only.

**AVAILABLE WITH A SLOPING BOTTOM LATH**

**AVAILABLE WITH A WICKET DOOR**

- Maximum width 7000 mm
- Maximum height 7000 mm
- Maximum area 49 m<sup>2</sup>
- Wind class rating: Class 2 (when used on 65 mm+ guides)

**Vision options**

- Available with full or part vision
- Max area of vision 16 m<sup>2</sup>
- Delivers up to 30% vision (when back lit)

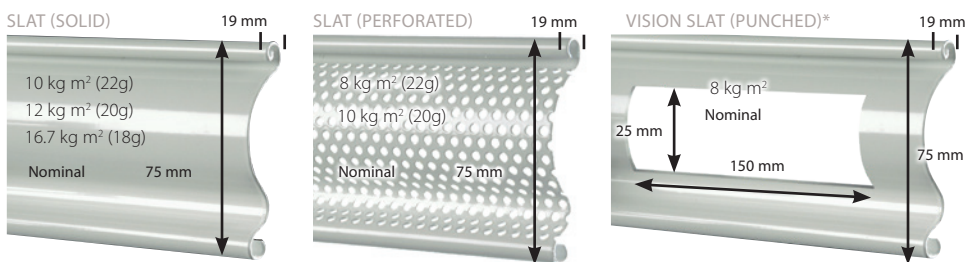

**Punched Curtain**  
150 mm x 25 mm regular punched hole with 50 mm space between. Available in brickbond or in line configuration.

**BOTTOM RAIL & GUIDE OPTIONS**

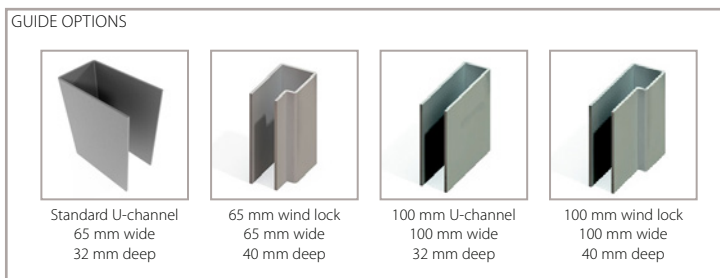

**SeceuroDoor | 7502**  
Insurance Approved Industrial Doors

Level 2 Insurance  
Approved Industrial  
Door



High-security single skin industrial door with independent testing and approval to LPS 1175. Level 2 security rating and Secured by Design approved. A popular choice when high security is required for larger or high-use doors.

- Security level 2
- High security industrial applications
- Strong 18g single skin galvanised steel profile
- Galvanised steel finish as standard
- Can be powder coated any RAL / BS colour
- Plastisol colours available
- Spans widths up to 7000 mm
- Internal face fit only
- Bullet lock fitted to the internal side as standard (accessed from the inside of the building only)

**THIS PRODUCT CAN BE POWDER COATED**  
Note: this product will be powder coated after it has been assembled.

**THIS PRODUCT CAN BE PLASTISOL COATED**  
Note: finish applies to the external face of curtain only.

**SeceuroDoor | 77**  
Insulated Industrial Doors

Insulated Industrial Door

Our insulated steel industrial door combines all the qualities of our robust SeceuroDoor 75 but with the added benefit of insulation. Minimal thermal bridges and the use of fine-pored PU rigid foam infill ensure good thermal insulation whilst curtain and sealing technology used around the entire shutter reduce noise from both inside and outside.

- Lath heat transmission performance: 4.01 W/m<sup>2</sup>K
- Galvanised steel finish as standard
- Can be powder coated any RAL / BS colour
- Max width 6000 mm
- Max area 20 m<sup>2</sup>
- Wind class rating: Class 2
- Choice of 4 guide arrangement options
- Standard guide angle is 75 mm x 50 mm  
Other sizes are available on request

**THIS PRODUCT CAN BE POWDER COATED**  
Note: this product will be powder coated after it has been assembled.

**AVAILABLE WITH A SLOPING BOTTOM LATH**

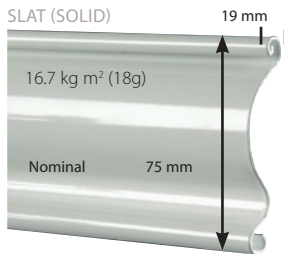

BOTTOM RAIL AND GUIDE

**BOTTOM SLAT T-RAIL**

74 mm wide  
68 mm high  
Also available with D rubber or optical safety edge

**GUIDE**

100 mm wind lock  
100 mm wide  
40 mm deep

**GUIDE**

90 mm wide  
34 mm deep

**BOTTOM SLAT**

77 mm high  
17 mm deep

**BULLET LOCK**

Bullet Lock      Isolator Box

Bullet locks require a double pin isolator box on motors over 140 Nm to prevent the door from operating when the lock is engaged.





SeceuroDoor 95  
Anthracite Finish with Vision



SeceuroDoor 95  
Galvanised Finish

## SeceuroDoor | 95 Insulated Industrial Doors



### High-Performance Insulated Industrial Door

Dual-walled steel profile with high-density injected foam core for maximum thermal and sound insulation. Reduces heat loss and lowers energy usage. Curved and ribbed lath design delivers added strength, reduced deflection and enhanced security. Smoother and quieter during operation than single skin profiles, with less curtain rattle in high winds.

- Durable insulated galvanised steel profile
- Lath heat transmission performance:  
Centre = 1.1 W/m<sup>2</sup>K, Quirk = 3.2 W/m<sup>2</sup>K
- Galvanised steel finish as standard
- Can be powder coated any RAL / BS colour
- Plastisol colours available
- Choice of 4 guide arrangement options
- Standard guide angle is 100 mm x 50 mm

- Max width up to 7000 mm
- Max height up to 7000 mm
- Max area 44 m<sup>2</sup>
- Wind class rating (lath): Class 5

#### Vision option available

- Available with clear perspex vision windows with 170 mm spacing - brickbond or in-line pattern
- Increased natural light and visibility of vehicles

SLAT (INSULATED)  
13.15 kg m<sup>2</sup>  
Nominal

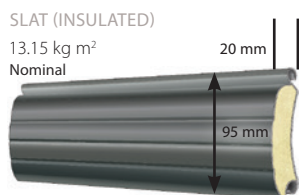

SLAT (VISION)  
13.15 kg m<sup>2</sup>  
Nominal

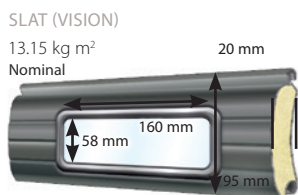

BOTTOM RAIL & GUIDE

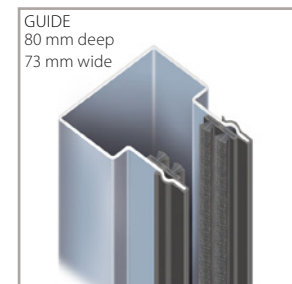

**THIS PRODUCT CAN BE POWDER COATED**

Note: this product will be powder coated after it has been assembled.



**THIS PRODUCT CAN BE PLASTISOL COATED**

Note: finish applies to the external face of curtain only.

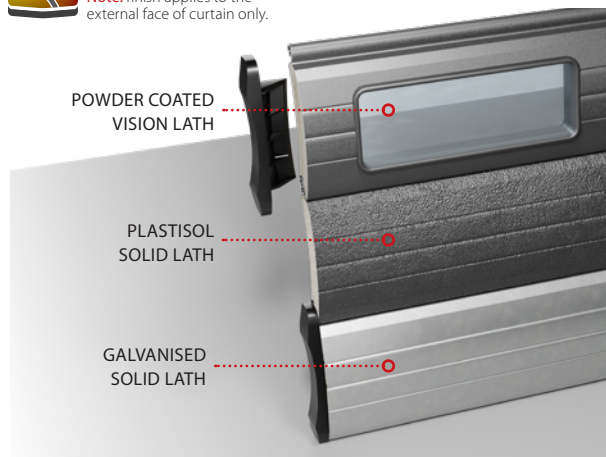

## SeceuroDoor | 9501 Insurance Approved Insulated Industrial Doors

## SeceuroDoor | 100 Insulated Industrial Doors

### Level 1 Insurance I Approved Insulated Industrial Door



All the benefits of the best-selling 95, with independent testing and approval to LPS 1175. Level 1 security rating and Secured by Design approved. A popular choice for higher security commercial/industrial applications.

#### LPCB Requirements:

The product must be internally face fitted around the opening. The head (axle/box/canopy) must be concealed behind the structure of the building. Bullet lock must be fitted to the internal side (accessed from the inside of the building only).

- Security level 1
- Higher security industrial applications
- Durable insulated galvanised steel profile
- Lath heat transmission performance:  
Centre = 1.1 W/m<sup>2</sup>K, Quirk = 3.2 W/m<sup>2</sup>K
- Galvanised steel finish as standard
- Can be powder coated any RAL / BS colour
- Plastisol colours available
- Choice of 4 guide arrangement options
- Standard guide angle is 100 mm x 50 mm
- Max width up to 7000 mm
- Max height up to 7000 mm
- Max area 44 m<sup>2</sup>
- Wind class rating (lath): Class 5



**THIS PRODUCT CAN BE POWDER COATED**  
Note: this product will be powder coated after it has been assembled.



**THIS PRODUCT CAN BE PLASTISOL COATED**  
Note: finish applies to the external face of curtain only.

#### SLAT (INSULATED)

13.15 kg m<sup>2</sup>  
Nominal

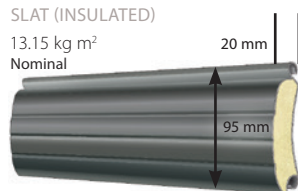

#### BOTTOM RAIL & GUIDE

##### BOTTOM SLAT

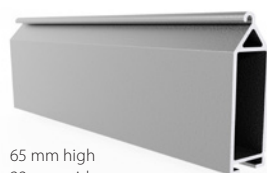

65 mm high  
23 mm wide

##### GUIDE

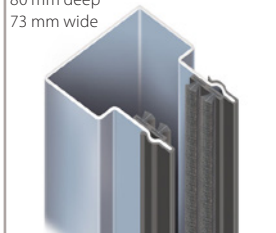

80 mm deep  
73 mm wide

#### BULLET LOCK



Bullet Lock



Isolator Box

Bullet locks require a double pin isolator box on motors over 140 Nm to prevent the door from operating when the lock is engaged.

### Hardened Steel Insulated Industrial Door

Twinwall steel profile with rigid CFC-free polystyrene infill providing excellent thermal benefits, reduced heat loss and lowering energy usage. Curtain and sealing technology around the entire shutter reduce noise from both inside and outside.

- Insulation infill heat transmission performance: 0.553 W/m<sup>2</sup>K
- Galvanised steel finish as standard
- Can be powder coated any RAL / BS colour  
*Up to 6500 mm wide only*
- Vision option available – 200 mm x 55 mm clear perspex vision panels with a minimum of 200 mm space in between
- Choice of 4 guide arrangement options
- Standard guide angle is 100 mm x 50 mm
- Max width 7000 mm
- Max height 7000 mm
- Max area 49 m<sup>2</sup>
- Wind class rating: Class 2

#### Vision options

- Available with 200 mm x 55 mm clear perspex vision windows with 200 mm spacing
- In-line pattern only
- Increased natural light and visibility of vehicles



**THIS PRODUCT CAN BE POWDER COATED**  
Note: this product will be powder coated after it has been assembled.

Note: finish applies to the external face of the curtain slat only.

#### SLAT (INSULATED)

18 kg m<sup>2</sup>  
Nominal

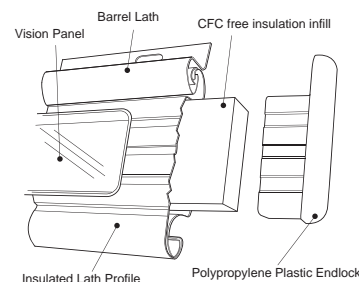

#### BOTTOM RAIL & GUIDE

##### BOTTOM SLAT

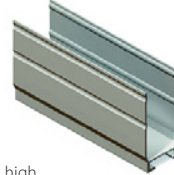

45 mm high  
25 mm wide

##### GUIDE (DEFAULT)

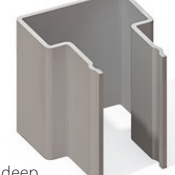

78 mm deep  
68 mm wide





SeceuroDoor 75 Chain Op  
Galvanised Finish



## SeceuroDoor Manual

# Hand-Operated Shutters & Doors

### Reliable Security, No Power Required

Manually operated shutters and doors are the ideal solution for locations where no power supply is available or where the shutter will not be opened very often.

Hand operation provides cost-effective security with smooth, reliable performance. No electrical components keeps installation and running costs low, while the simple mechanical operation reduces servicing needs.

Available in two options:

- **Spring & Lock Operation** – perfect for smaller openings such as shopfronts, kiosks and storage areas.
- **Chain Operation** – ideal for larger industrial applications where extra strength and ease of use are essential.



SeceuroDoor 75 Chain Op  
Galvanised Finish



SeceuroDoor 75 Spring Op  
Galvanised Finish



### Galvanised Steel Single Skin Continental Spring Op Shutter

- Medium security office / commercial / retail applications
- Strong 22g single skin galvanised steel profile
- Neat powder coated aluminium guides
- Galvanised steel finish as standard
- Can be powder coated any RAL / BS colour
- Plastisol colours available
- Will reverse coil if required (will increase coil size)
- Max width up to 4000 mm
- Max height up to 2800 mm
- Max area up to 8 m<sup>2</sup>
- Wind class rating: Class 2

#### Vision options

- Available with full or part perforated vision
- Delivers up to 30% vision (when back lit)

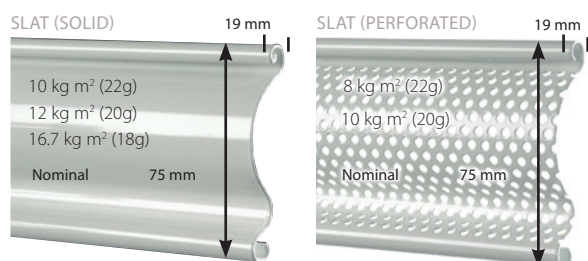

### Galvanised Steel Single Skin Traditional Spring Op Shutter

- Medium security office / commercial / retail applications
- Strong 22g single skin galvanised steel profile
- Galvanised steel finish as standard
- Can be powder coated any RAL / BS colour
- Plastisol colours available
- Will reverse coil if required (will increase coil size)
- Max width up to 4000 mm
- Max height up to 2800 mm
- Max area up to 8 m<sup>2</sup>
- Wind class rating: Class 2 (when used on 65 mm+ guides)

#### Vision options

- Available with full or part perforated vision
- Delivers up to 30% vision (when back lit)



#### BOTTOM RAILS & GUIDE OPTIONS

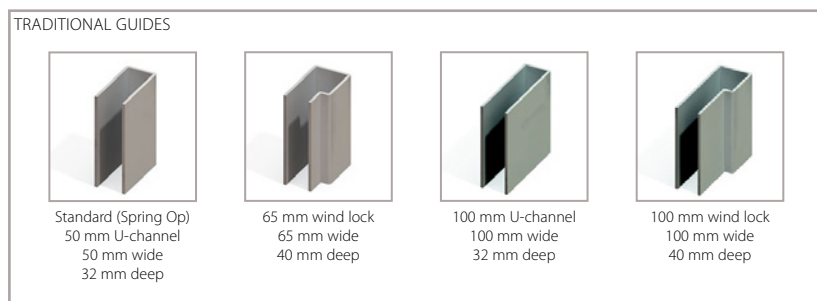
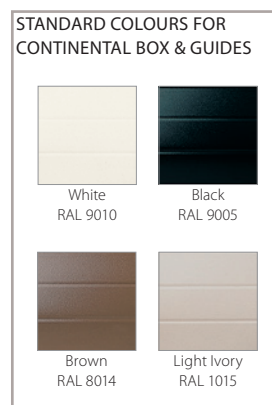
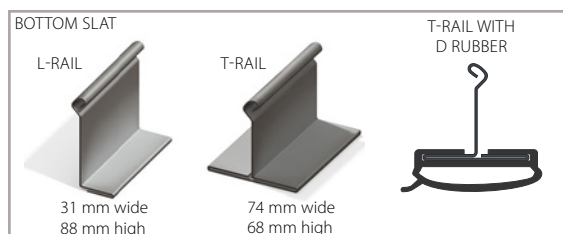

**Please note:**  
Colour references are a guide only and will not match powder coated finish.

# SeceuroDoor | 7501

Spring Operated Insurance Approved Security Shutters



## Level 1 Insurance Approved Spring Op Shutter

Spring operated shutter with independent testing and approval to LPS 1175. Level 1 security rating and Secured by Design approved. A popular choice for low-use higher security applications.

- Security level 1
- Higher security office / commercial / retail applications
- Strong 22g single skin galvanised steel profile
- Galvanised steel finish as standard
- Traditional or continental design
- Can be powder coated any RAL / BS colour
- Plastisol colours available
- Available as solid or with full or partial perforated vision
- Spans widths up to 4000 mm
- Will reverse coil if required (will increase coil size)
- Wind class rating: Class 2

**THIS PRODUCT CAN BE POWDER COATED**  
 Note: this product will be powder coated after it has been assembled.

**THIS PRODUCT CAN BE PLASTISOL COATED**  
 Note: finish applies to the external face of the curtain slat only.

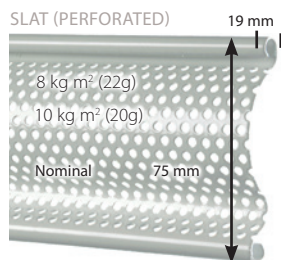

# SeceuroDoor | 75c

Manual Chain Operated Industrial Door

## Chain Operated Industrial Door

Our manual chain operated door combines all the qualities of the robust SeceuroDoor 75 but with the added benefit of manual operation, ideal for lower usage applications where power is not available.

- Galvanised steel finish as standard
- Can be powder coated any RAL / BS colour
- Plastisol colours available
- Vision options available see page 8 for further information
- Choice of 4 guide arrangement options
- Standard guide angle is 75 mm x 50 mm
- Other sizes are available on request
- Max width 5000 mm
- Max height 5000 mm
- Max area 25 m²
- Wind class rating: Class 2 (when used on 65 mm+ guides)

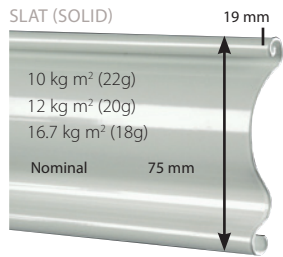

**THIS PRODUCT CAN BE POWDER COATED**  
 Note: this product will be powder coated after it has been assembled.

**THIS PRODUCT CAN BE PLASTISOL COATED**  
 Note: finish applies to the external face of the curtain slat only.

**AVAILABLE WITH A WICKET DOOR**

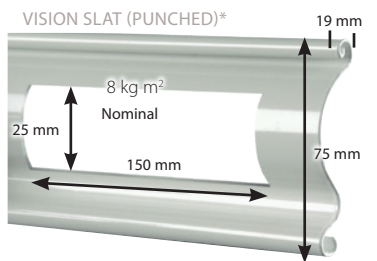
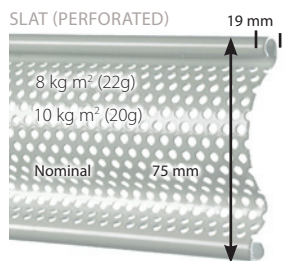

### BOTTOM RAIL & GUIDE OPTIONS

**TRADITIONAL GUIDES**

Standard 65 mm wind lock  
65 mm wide  
40 mm deep

100 mm wind lock  
100 mm wide  
40 mm deep

**CONTINENTAL GUIDE**

90 mm wide  
34 mm deep

**BOTTOM SLAT**

T-RAIL

74 mm wide  
68 mm high

Also available with D rubber or optical safety edge

**STANDARD COLOURS FOR CONTINENTAL BOX & GUIDES**

White RAL 9010    Black RAL 9005

Brown RAL 8014    Light Ivory RAL 1015

### BOTTOM RAIL & GUIDE OPTIONS

**GUIDE OPTIONS**

Standard U-channel  
65 mm wide  
32 mm deep

65 mm wind lock  
65 mm wide  
40 mm deep

100 mm U-channel  
100 mm wide  
32 mm deep

100 mm wind lock  
100 mm wide  
40 mm deep

**BOTTOM SLAT**

T-RAIL

74 mm wide  
68 mm high

Also available with D rubber or optical safety edge

**AVAILABLE WITH A SLOPING BOTTOM LATH**

**AVAILABLE WITH A WICKET DOOR**



## SeceuroDoor | 77c Insulated Manual Chain Operated Industrial Door

### Insulated Chain Operated Industrial Door

Manually operated door with the added benefits of a strong, foam-filled insulated profile. Ideal for low usage applications where power is not available but there is a requirement to maintain internal temperatures, reducing heat loss in winter and heat gain in summer.

- Heat transmission performance for an operational door: 4.01 W/(m<sup>2</sup> K)
- Galvanised steel finish as standard
- Can be powder coated any RAL / BS colour
- Choice of 4 guide arrangement options
- Standard guide angle is 75 mm x 50 mm  
Other sizes are available on request
- Max width 5000 mm
- Max height 4000 mm
- Max area 20 m<sup>2</sup>
- Wind class rating: Class 2



**THIS PRODUCT CAN BE  
POWDER COATED**

**Note:** this product will be powder coated after it has been assembled.

SLAT, BOTTOM SLAT & GUIDE

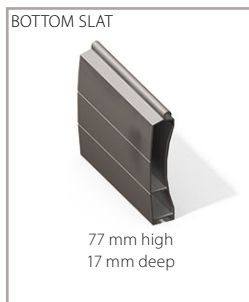

SeceuroDoor 75 Perforated  
With Wicket Access Door

## Wicket Access Doors

### Convenient Pedestrian Access

Wicket doors provide easy pedestrian access without opening the full shutter, saving time and money.

Available on Traditional and Industrial SeceuroDoor 75, in a choice of two sizes:

- Standard: 560 mm x 1605 mm
- Euro: 800 mm x 1830 mm

Wicket doors are supplied powder coated to match the curtain as standard. On galvanised shutters, the wicket door is supplied powder coated in RAL 9006 in a satin finish.

On motor operated shutters, an interlock is recommended to prevent the shutter from being operated when the wicket door is open.

# SeceuroDoor Industrial Installation Options

We are able to offer four standard variations of guide angle arrangement. The appropriate solution will depend on the structure the product is being fitted to and the application.

	Arrangement	Guide Angle
Motor	Face	Inset/Outset
	Reveal	Outset
	Mixed	Inset/Outset
Chain	Face	Inset/Outset
	Reveal	Outset

Typical Face Fit Arrangement - Outset Angles

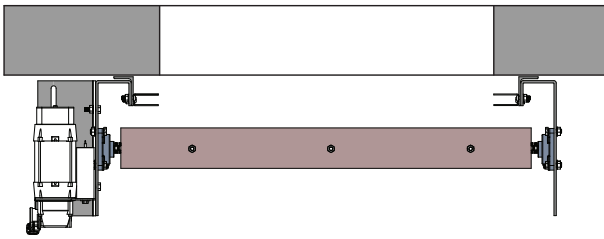

Typical Reveal Fit Installation - Outset Angles

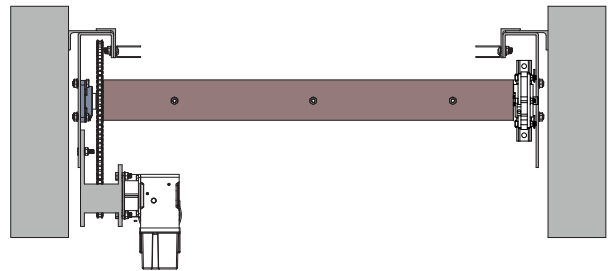

Typical Direct Drive Assembly



Typical Inboard Assembly

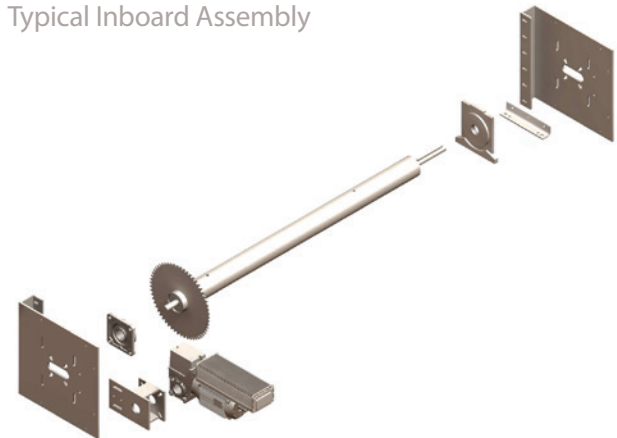

Typical Manual Chain Operated Assembly

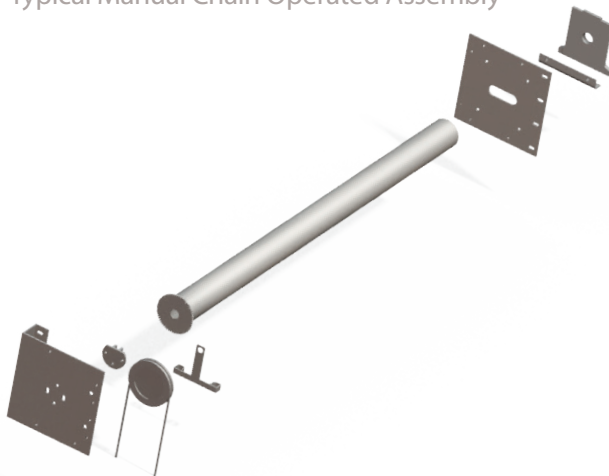

PLASTISOL  
SOLID LATH

Universal, Laser-Cut, Folded End Plate

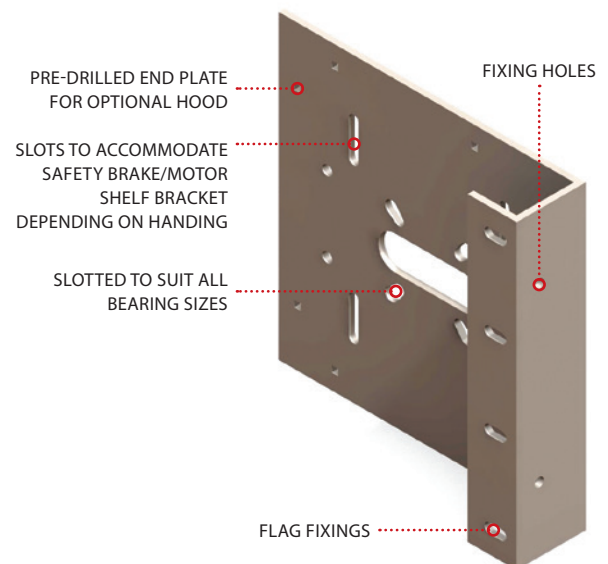

# Powered by GfA Industrial Drives



GfA offers a wide range of industrial motors, including Safedrive®, which features a built-in patented safety brake, anti-fallback device and convenient digital limits.

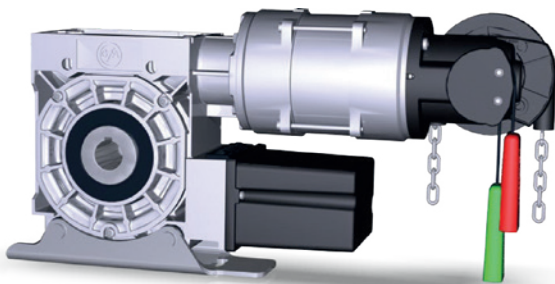

## SAFEDRIVE® (SI)

Direct Drive with Built-in Anti-Fallback Device

- Patented built-in safety brake
- Range of output speeds and torques
- Horizontal or vertical mounting
- Emergency low level hand chain operation as standard
- Plug-connected control equipment
- Digital "DES" limits as standard
- Sealed units designed to be maintenance free
- Certified to BS EN 12453 and 12604

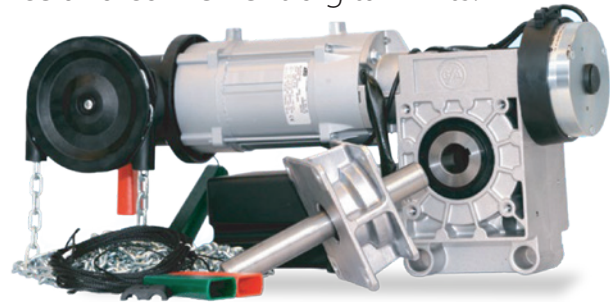

## RANGER (SE)

For Doors which are Counter-Balanced or Fitted with a Separate Safety Brake

- Range of output speeds and torques
- Horizontal or vertical mounting
- Foot mounting available on Ranger 90, 120W and 140
- Emergency low level hand chain operation as standard
- Plug-connected control equipment
- Digital "DES" limits as standard
- Certified to BS EN 12453

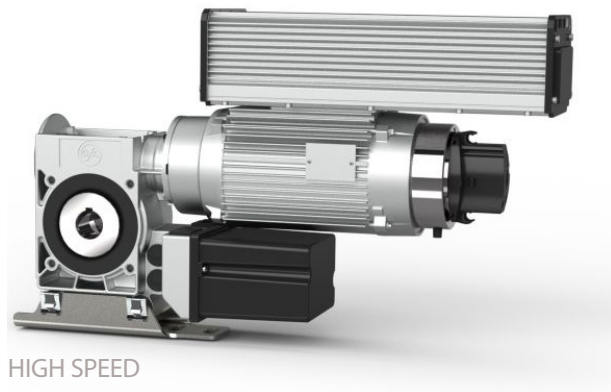

## HIGH SPEED

Fast and Reliable Opening for High-Traffic Applications

- Range of higher speeds to save time and money
- Available with a built-in safety brake (SI)
- Available in single or variable speed (FI)
- Available with either digital or mechanical limits
- Emergency low level hand chain operation as standard
- Plug-connected control equipment
- Digital "DES" limits as standard
- Certified to BS EN 12453

## Exclusive 2 Year Extended Warranty:



### Available on GfA Industrial Motors

Only SWS UK offers an extended 2-year warranty on GfA industrial motors, when you register each drive using the GfA bluetooth dongle. Registration is easy and comes with a host of other benefits:

- ✓ View and track all your registered GfA assets in one place
- ✓ Monitor ongoing usage
- ✓ Keep track of drive settings over time
- ✓ Access a comprehensive library of fault codes
- ✓ Synch your service records

### TIP

Our online configurator automatically suggests drive options based on expected usage.



Ellard and Marantec motors are also available, supplied with a 3 button hold-to-run pushbutton station.

# Controls & Accessories

## SeceuroDoor Tubular Shutters



### Rocker Switch (Standard)

Wired toggle switch positioned directly next to the shutter.

Provides simple up/down hold-to-run operation. Ideal for low- to mid-use shutters with restricted access such as private offices/commercial premises.



### Somfy Smoove

Single or dual pole wired wall switch for the operation

of one or two shutters. Sleek, modern design from market-leaders Somfy with press and hold operation.

**somfy**



### Secure Keyswitch

Surface mounted keyswitch that

requires a key to operate the shutter. Prevents unauthorised use in public areas or by untrained users. Hold-to-run operation, suitable for low- to mid-use applications.



### SeceuroSense Plus

Available exclusively from SWS UK, this wireless control unit provides impulse shutter operation. Supplied with a wireless optical safety edge for automatic object detection, suitable for shutters over doors or walkways.

Includes two 2-channel handsets, automatic courtesy light and push buttons on the panel.



### Somfy Rollixo

Wall-mounted wireless control unit supplied with an infrared optical safety edge for automatic object detection and two 4-channel handsets, enabling remote control of up to 4 individual shutters.

Includes an integrated courtesy light, push buttons on the panel and a built-in 100 dB security alarm.

**somfy**

## SeceuroDoor Industrial Doors



### Pushbutton Control

Ellard and Marantec industrial motors are supplied with a wired, surface-mounted pushbutton control. Up, stop and down buttons provide hold-to-run operation of a single door, ideal for low- to mid-use applications.

*Pushbutton design varies depending on the motor.*



### GfA TS Control Panel

GfA industrial motors are supplied with a wall-mounted TS control panel, available with hold-to-run operation or with an integrated wired or wireless safety edge system.

Features simple plug-and-play installation, ground-level limit setting, digital fault diagnostics and maintenance counters.



# Safe & Efficient



For operation over a door or walkway, safety and efficient traffic flow are essential. SeceuroDoor offers a range of accessories designed to keep busy businesses running smoothly and without disruption.

## Safety & Control

The **GfA TS 971** control panel offers a host of enhanced features, including an integrated safety edge system for reliable object detection without the need for an additional receiver.

The built-in radio receiver means **up to 64 hand transmitters** can be directly paired to the panel, providing safe and reliable remote control, suitable for private car parks and multi-user applications.

The TS 971 has an in-built power supply of either 350 mA or 1000 mA, allowing accessories to be directly connected to the control panel, accommodating a combined consumption of **up to 1000 mA**.

TS 971 Control Panel with optional extras:

- Latching E-Stop Button
- Key Selector Switch
- Toggle Selector Switch



TS Cover Plate



Loop Detector

## Optimised Traffic Flow

For enhanced safety, efficiency and organisation in environments where both vehicles and pedestrians operate in close proximity, red and green **LED traffic lights** ensure safe and efficient traffic flow.

The GfA **induction loop detector** automatically detects the presence of a vehicle over a buried wire loop, sending a signal to the connected control panel to operate doors or accessories, such as traffic lights, beacons or audible warning devices.

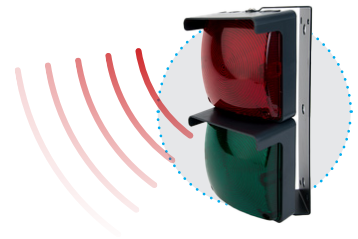

With a range of sensors and accessories from **BEA**, SeceuroDoor Industrial Doors can be activated, monitored and protected to streamline your workflow in confidence.



### Condor

Combined microwave motion detector and infrared

presence sensor for precise detection of stationary vehicles and objects and energy-efficient operation.



### LZR®-I100 / I110

Uses high-precision laser beams on 4

planes to provide optimal safety in the door threshold and proximity, with a detection range of up to 9.9 m x 9.9 m.



### LZR®-Widescan

Provides door activation, area surveillance and

people protection using cutting edge laser technology. Optimises traffic flow, energy savings and enhances door safety with easy installation via an app.



## Colours & Finishes

The full SeceuroDoor range is supplied in a galvanized finish as standard.

A hot-dipped zinc coating creates a protective layer that offers superior corrosion resistance and protection from weathering.

SeceuroDoor products are also available powder coated in any RAL or BS colour or in a range of plastisol finishes for a surcharge.

### In-House Powder Coating

At SWS UK, our in-house powder coating facilities in both Lancaster and London ensure exceptional quality and consistency. This means every SeceuroDoor product can be fully customised in any RAL or BS colour, with the added benefit of rapid lead times and a durable finish that lasts.

### Blend In or Stand Out

With an extensive range of colours, SeceuroDoor lets you blend seamlessly with existing building facades, match your brand identity or make a bold statement on the high street.





## POWDER COATING

60-80 micron coating thickness. High performance finish that delivers exceptional corrosion protection, durability and colour stability. SeceuroDoor 75 and 100 are supplied in a satin finish (gloss level 65% +/-5%). SeceuroDoor 77 and 95 are supplied in a matt finish (gloss level 30% +/-5%). Powder coating of the SeceuroDoor 100 will be to the external face only.

### Looking for something different?

If you require assistance identifying or selecting a colour which does not appear on our list of stock colours we can supply you with a RAL colour chart.

#### BAND A

\* FOC on SeceuroDoor 75 continental box and guides

Beige RAL 1001	Oyster White RAL 1013	Light Ivory* RAL 1015	Grey Beige RAL 1019	Gentian Blue RAL 5010	Light Blue RAL 5012	Moss Green RAL 6005	Iron Grey RAL 7011	Anthracite RAL 7016	Graphite Grey RAL 7024	Pale Grey RAL 7035	Agate Grey RAL 7038
Brown* RAL 8014	Chestnut Brown RAL 8015	Chocolate Brown RAL 8017	Grey Brown RAL 8019	Grey White RAL 9002	Black* RAL 9005	White* RAL 9010	Graphite Black RAL 9011	Brilliant White RAL 9016	Traffic Black RAL 9017	Grey Goose BS 00A005	Brown BS 08B29

#### BAND B

Ivory RAL 1014	Oxide Red RAL 3009	Royal Blue RAL 5002	Navy Blue RAL 5011	Pale Blue RAL 5015	Fir Green RAL 6009	Pale Green RAL 6021	Dark Grey RAL 7015	Pale Grey RAL 7047	Clay Brown RAL 8003	Red Brown RAL 8012	Mahogany RAL 8016
Cream RAL 9001	Off White RAL 9003	Signal Black RAL 9004	Papyrus White RAL 9018	Sand Yellow RAL 1002	Olive Yellow RAL 1020	Signal Blue RAL 5005	Grey Blue RAL 5008	Pigeon Blue RAL 5014	Water Blue RAL 5021	Ochre Brown RAL 8001	Silk Grey RAL 7044

#### BAND C

Green Beige RAL 1000	Daffodil Yellow RAL 1007	Yellow RAL 1018	Signal Orange RAL 2010	Signal Red RAL 3001	Dark Red RAL 3011	Traffic Red RAL 3020	Dark Blue RAL 5003	Capri Blue RAL 5019	Ocean Blue RAL 5020	Leaf Green RAL 6002	Black Olive RAL 6015
May Green RAL 6017	Mint Turquoise RAL 6033	Telegrey RAL 7046	Olive Brown RAL 8008	Orange Brown RAL 8023	Lemon Yellow RAL 1012	Night Blue RAL 5022	Distant Blue RAL 5023	Reseda Green RAL 6011	Copper Brown RAL 8004	Beige Brown RAL 8024	Poppy Red BS 04E53



## PLASTISOL

A 200 µm PVC protective coating in a leathergrain embossed finish that forms a thick, durable layer on the external face of the curtain. Available on solid SeceuroDoor 75 22g/20g and SeceuroDoor 95.

### FEATURES

- **Corrosion Resistant:** Provides long-term protection against rust and oxidation.
- **Durable:** Tough and practically indestructible, providing long-lasting protection.
- **Chemically Inert:** Suitable for environments where chemical exposure is possible.
- **Resistant to Organic Contamination:** Resists mold and mildew growth and is unaffected by moisture.
- **Impact Resistant:** Virtually unbreakable by impact, adding an extra layer of protection.
- **Temperature Tolerant:** Suitable for various environmental conditions and exposed shutters.

White	Black	Goosewing Grey	Merlin Grey	Anthracite Grey	Ocean Blue
Slate Blue	Sargasso Blue	Moorland Green	Olive Green	Juniper Green	Mushroom
Vandyke Brown	Poppy Red	Aztec Yellow	Solent Blue		

**Note:** Availability of plastisol colours varies, depending on the lath type.



SeceuroFire Fire Shutter

## Other Commercial Products



SeceuroFire Fire Shutters are the perfect solution where fire protection is needed alongside security. Automatic closing when fire or smoke is detected prevents the spread of flames and smoke through openings like serveries, windows and doors.

The intelligent battery backup feature ensures reliable operation, even in the event of power failure. Available in 30, 60, 120 or 240 minute integrity ratings and tested to BS EN 16034 fire resistance and BS EN 13241 performance standards.



SeceuroShield combines easy operation with robust security for homes and businesses. The range includes single skin and insulated aluminium roller shutters, retractable security gates and window bars, all available in a range of durable powder-coated colours to integrate seamlessly with the building.

SeceuroShield shutters are available with powerful and reliable tubular motor operation or manual options and a choice of vision options, ideal for retail shopfronts.



SeceuroShield 38 Vision



SeceuroGuard Retractable Security Gates offer elegant, strong protection for domestic, retail or commercial properties. Designed to keep intruders out while allowing maximum light, they're perfect for vulnerable ground-floor windows and doors.

The gates fold neatly out of sight when not in use. They are safe, easy to use and quiet, with an optional base track for quick folding.



SeceuroGuard 1000 Retractable Gates

# Important Information

Due to ongoing product development and changes in technical performance, specifications and information are subject to change without notice.

## Colours & Finishes

- The printing process does not allow exact reproduction of the paint colours. If you are unsure of your colour choice please ask your supplier for a sample. Colour references quoted are the nearest standard RAL or BS number to the colours used. They will not be an exact match and are intended as a guide only.
- Multiple doors should be ordered together to obtain the best colour match, bearing in mind the limitations of the materials used in construction.
- Due to the manufacturing process the guide rails may not be an exact match to the slat colour. The manufacturing process for the slat profile results in a textured finish while all other coloured items (guide rails, bottom slats, end plates, optional fascias and vision panels) are supplied in a smooth finish so we cannot guarantee an exact match.
- Due to the powder coating process, an un-painted area of each slat is visible on the quirk when the door is opening/closing. This should not be visible when the door is in the closed position.
- The factory application of the paint finish involves an automated process and this may result in minor blemishes or slight inconsistencies in the paint.
- We recommend that you perform a visual quality check on installation. Carry out the quality check in natural daylight, not direct sunlight. Stand at a distance of 3 metres from the product to view the overall appearance.
- The product is acceptable if, taking into account the facts below, none of the following is readily visible on the face of the product:
  - Marks or distortions associated with the manufacturing process
  - Minor indentations, marks or scuffs on the surface
  - Paint or stain blemishes
- While weathering and sun exposure can cause the exterior surface to fade, colour change or fade will be limited and uniform.

## Product Care

- Correct operation and care of your SeceuroDoor shutter or door in accordance with the official Operating & Maintenance Manual will prolong the life of your product and minimise the likelihood of issues.
- The product needs wiping with a damp cloth and a mild detergent to remove any excessive dirt/grime to maintain its appearance and to reduce the risk of the surface being damaged.
- Floor must be smooth, level and kept clear of dirt and debris, which can cause deterioration of the rubber seal.

## Extreme Weather Conditions

- High winds and high temperatures on double doors can cause increased deflection of the door. It is the installer's responsibility to ensure that the door is spaced off the wall sufficiently to allow for door movement during these extreme weather conditions.
- Larger dark coloured doors that are exposed to significant direct sunlight may be susceptible to expansion which may interfere with the operation of the door.
- If a door is situated in an exposed location and subjected to very high winds and driving rain, SeceuroDoor does not guarantee against water ingress. As part of the product's testing for the CE or UKCA marking, the product has not been tested against this and as such is classified as NPd (No Performance Declared).
- Whilst the profiles are primed and coated for the external environment – any doors fitted in coastal environments may be at risk of deterioration due to the weather conditions.
- Regular cleaning of products in 'high corrosive areas' such as within 2 miles of the sea is especially important. Your door should be cleaned thoroughly weekly using warm water and mild detergent with a soft cloth or sponge. Allow to dry naturally. Never use strong detergent, abrasive, caustic or solvent-based cleaners.
- In the event of extreme weather conditions, vision slats will be susceptible to water ingress and may cause the door to move in extreme gales.

## Marking

The nature of roller shutters means marking may appear on the internal side of the slats over time. Occasionally some marking may occur at the top of the concave (coil) side of the curtain over time. This is unavoidable and due to prolonged contact with the locking system. On doors which are installed externally this will be visible on the outside.

## Warranty Conditions

- The SeceuroDoor warranty covers parts only and does not cover labour costs or consequential costs, including but not limited to call-out fees, transport costs and costs remedial work for removing and/or re-installing faulty parts.
- SWS UK will replace or repair any components of our products where the manufacturing process has resulted in a defect occurring during the relevant period, subject to the exceptions and conditions set out below.
- For all replacement electrical parts, the warranty period is 12 months or the remainder of the warranty period (whichever is the longest).

### The warranty does not cover the following:

- ✗ Any marks, distortion, stains, blemishes, indentations or scuffs which are not observable from at least 3 metres away in natural light (not direct sunlight).
- ✗ Defects which are as a result of:
  - Incorrect installation of the product, not following SWS UK's installation instructions.
  - Incorrect or lack of proper care and maintenance of the product in accordance with SWS UK's Operating & Maintenance Manual.
  - Incorrect operation of the product.
  - Any modifications made to the product made by anyone other than SWS UK.
  - Normal wear and tear.
  - Accidental or malicious damage.
  - Impact damage or scratches, dents, scuffs or other minor abrasions.
  - Use or attempted use of non-SWS UK spare parts.
  - Repairs or attempts at repairs undertaken by any person other than someone specifically authorised by SWS UK.
  - Any failure of masonry or other structures on to which the product has been fixed.
  - Any attempt to reduce operating clearances by means of infills or draughtproofing.
  - External influences such as extreme or abnormal weather conditions, fire, water, salts, chemicals and bird droppings.
  - Any fault or surge in the customer's electricity.
- ✗ Rust or corrosion caused by exposure to saltwater or salty air for products installed within **500 metres of the sea** or a large body of saltwater. For products installed within 2 miles of the sea, the exterior finish of the product is guaranteed for a limited period of 2 years.
- ✗ Consumables such as fuses, light bulbs or batteries.
- ✗ Indirect, special or consequential loss or damage howsoever caused, including remedial work costs, call-out fees, tool or plant hire and transport costs.

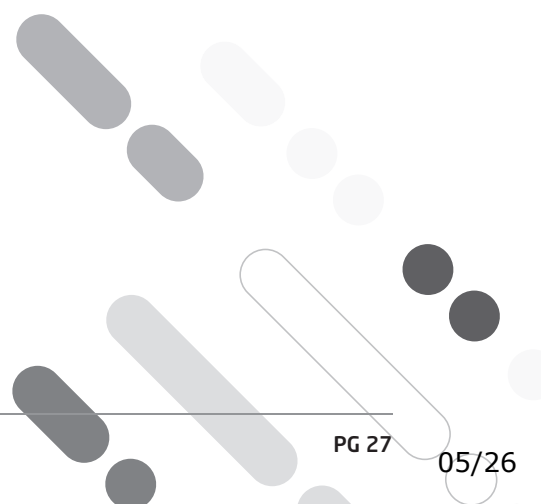

# Reasons to Choose SeceuroDoor

## ✓ A name you can trust

When buying a SeceuroDoor product you can be reassured by the values behind the name. Every SeceuroDoor shutter is CE or UKCA marked and SWS UK is an ISO9001 and ISO14001 certified company.

## ✓ Expert advice

With a full-time technical team, field support and a 24 – hour helpline on hand you can be confident in choosing a product with first class backup and service.

## ✓ Manufactured in the UK

Using the latest machinery and equipment, all SeceuroDoor products are proudly manufactured and assembled in either our Lancaster or London factory.

## ✓ A solution for everyone

With so much choice SeceuroDoor products can accommodate most industrial door requirements, whether you need insulation, vision, or are looking for a solution for a specific budget.

## ✓ Engineered to perfection

Through continuous development and specialist engineering, SeceuroDoor products offer unrivalled quality and the most advanced specifications. High emphasis is placed on ease of fitting and flexibility on site.

## The importance of conformity and CE and UKCA marking

To comply with the Machinery Directive both the shutter and the motor and controller used in the installation must have a **Declaration of Performance** from the manufacturer.

On completion of the installation the installer must provide a **Declaration of Conformity** and apply a CE or UKCA mark giving details of the installations to the shutter / motor and controller combination, which is now classed as a machine.

The installer must issue to the customer a Declaration of Conformity, operating and maintenance instructions on the completion of the installation.

The installer must hold copies of both the Declaration of Performance and the Declaration of Conformity on a technical file for inspection by the relevant authorities.

If any of the above requirements are not fulfilled the installation is illegal.

Please ensure for your own safety and peace of mind that whoever installs your electric motor and controller is both willing and able to fulfil these requirements; if they are not – do not use them.

As a member of the DHF we CAN and WILL install your motor and controller safely and legally.

# Peace-of-Mind Warranties

All SeceuroDoor products, including the motor are guaranteed against defect of material or workmanship by SWS UK, subject to correct installation, maintenance and operation, for a period of 1 year from the date of purchase.

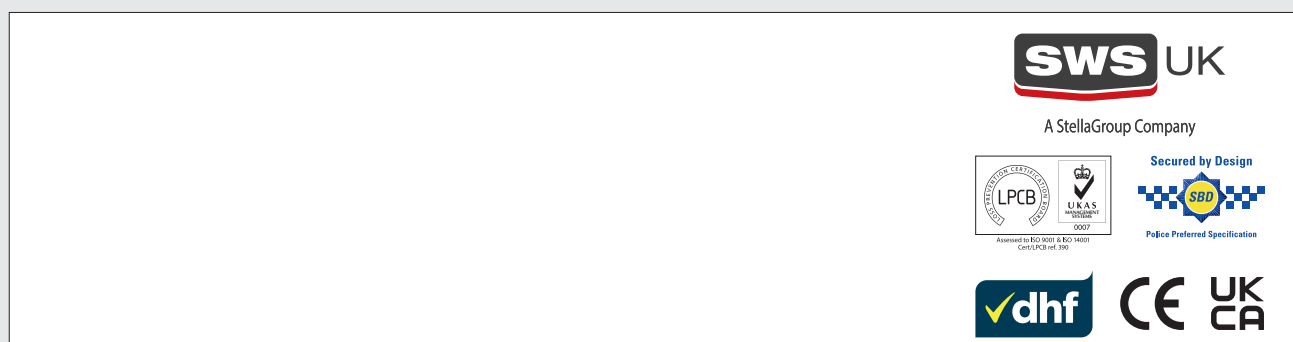

MK540B7 Mar 2026 R5

# Samson

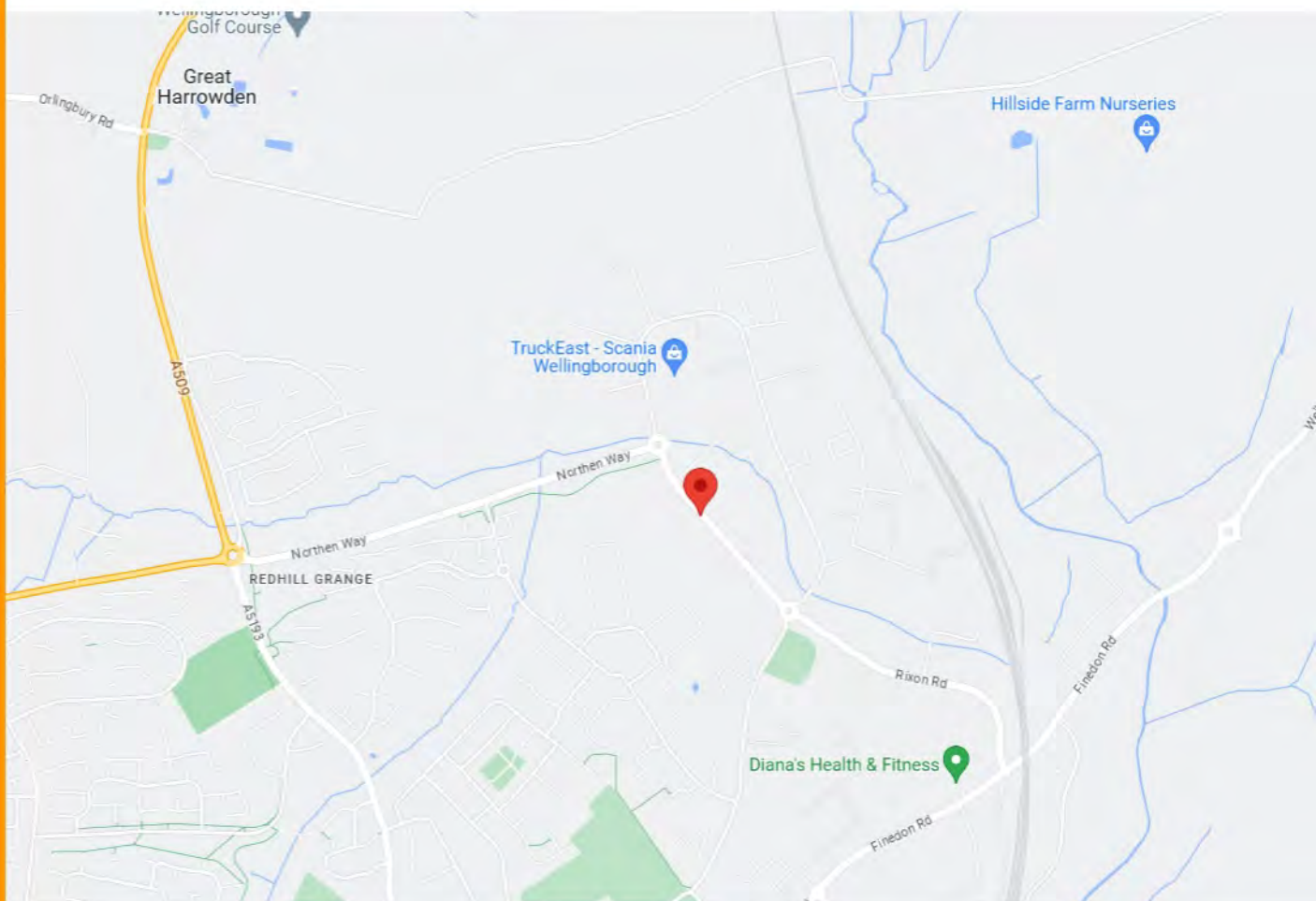

**29-31 STEWARTS ROAD  
WELLINGBOROUGH  
NORTHAMPTONSHIRE  
NN8 4RJ**

**EMAIL: [ENQUIRIES@SAMSONDOORS.CO.UK](mailto:ENQUIRIES@SAMSONDOORS.CO.UK)  
TELEPHONE: (01933) 448850  
MON - FRI 8:00AM - 5:00PM**

**SAMSON**

