

## THE FLEXIBLES.

Fast and secure folding doors in application





## **Performance promise and service standards**

Design | Security | Service

Pages 4 - 9

## **Our folding doors**

Overview

Page 10 - 11

Folding door „Teckentrup 50“ FE

Page 12 - 13

Fire brigade folding door „Teckentrup 50“ FE

Page 14 - 15

Folding doors with electrical drive

Page 16 - 17

## **Design variety**

For your individual demands

Pages 18 - 21

## **Security aspects**

Technology, convenience and operation

Page 22 - 25

Coupling types

Page 26 - 27

Installation details, technical data

Page 28 - 31

MADE  
IN  
GERMANY



# TECKENTRUP DOOR SOLUTIONS

Whether it's development, production or distribution, whether it's about the entire whole or about a small detail, for us, everything revolves around the decisive question: **WHAT IS THE SOLUTION FOR YOU?**

Because we are the specialist for fire protection, smoke protection, sound insulation and security doors, for industrial sectional doors, rolling shutters, folding doors, sliding doors and garage doors.

And we are **"Made in Germany"**. For more than 80 years, we have developed and produced our products exclusively in Germany. More than 900 employees at our locations in Verl and Großzöberitz create our high-quality products for you. All processes, from supply to production to commissioning and delivery, are based on the DIN EN ISO 9001 quality management system.

DESIGN

SECURITY

SERVICE

Teckentrup produces more than doors and gates: Teckentrup delivers solutions. Which is why we have applied three new standards to our company and our products which meet your needs: Design. Security. Service.

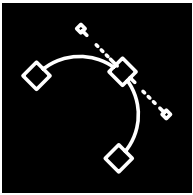

**Design:** We link functionality and aesthetics.

Because good design represents innovative technology that meets the needs of the user. Our products are opening new worlds and offer many individual design options. With us, designers and engineers work hand-in-hand from the beginning. So that intelligent ideas are just as convincing at the second glance and sophisticated designs prove themselves day after day.



**Security:** We link systems to protection.

Our doors meet the highest requirements and are certified accordingly. We are happy to advise you on necessary standards and develop comprehensive needs-oriented safety approaches in order to protect people and valuables.

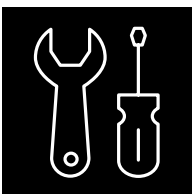

**Service:** We link speed to reliability.

Proximity, clear structures, everything from one source. This is the service advantage of Teckentrup. Because, from product development to installation, from the committed support of our expert advisers to professional servicing: we will be there for you right away. We are happy to make the time.



# BUILDING EXPERTISE FROM ONE SOURCE

Large construction projects are faced with enormous cost pressure. This is why all of our products are embedded in an approach for process optimisation. We count on holistic service – from planning to installation to operating our industrial sectional doors. We can support you with consultation and planning services, we provide just-in-time deliveries if required, we place great emphasis on easy installation and we are also there to help you at any time during the construction phase by providing solutions at short notice. Therefore, you can rest assured that you receive the right solution for all of your property's requirements.

---

## OUR SERVICES FOR YOU

Secure clear efficiency advantages for yourself in every project phase:

- Comprehensive property and project advising for each of your projects
- Digital configurator as first step to your individual door solutions
- Tender documents and technical drawings to develop your tender

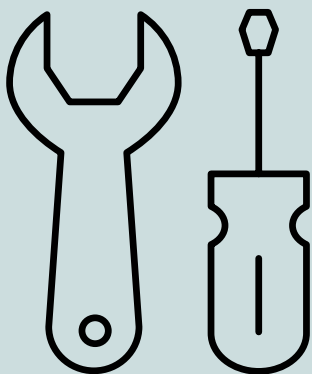

More information at [www.teckentrup.co.uk](http://www.teckentrup.co.uk)



# HOLISTIC SERVICE



**We provide custom solutions and comprehensive service to our customers, from project planning to installation to operating our doors. Take a look for yourself.**

## **SPORT FLYERS AIRPORT IN ODESSA FOLDING DOORS IN THE HANGAR**

Numerous sightseeing flights take off from "Hydroport" sport flyers airport in Odessa (Ukraine) and hobby pilots are passionate about sports aircraft. Large hangars were built to accommodate aircraft. A folding door with a width of 16 metres and a height of 5 metres seals off the hangar. The folding door leaf consists of several vertical elements that are connected to each other using hinges and are linked vertically to the frame. The double-walled design filled with mineral wool is heat-insulating and the multi-layer structure guarantees permanent durability. The galvanised material and the priming coat protect against the weather effects.





You can find more exciting property reports at  
[www.teckentrup.biz](http://www.teckentrup.biz)  
Tel: 01933 448 850

**TECKENTRUP**  
DOOR SOLUTIONS  
[www.samsondoors.co.uk](http://www.samsondoors.co.uk)

# PERFECT SOLUTION FOR WIDE FACILITY OPENINGS

## **Teckentrup steel folding doors**

Teckentrup folding doors are used in particular in large maintenance halls, storage depots, equipment halls or vehicle depots. Folding doors open to the side and are available in either 90 degree or 180 degree versions. Various filling and glazing options expand your room to play with the design. We also provide doors with electrical drives for applications where speed is required as well as a quick release system specially designed for the fire brigade.



### FE "Teckentrup 50" (manually operated)

Folding doors are commonly installed in very wide hall openings up to 16 meters, but also wherever spatial relationships are constrained inside or around the lintel. The Teckentrup FE "Teckentrup 50" folding door offers maximum security and reliability. The high levels of stability also enable use in areas subject to high winds, e.g. in mountainous and coastal regions.

### "Teckentrup 50" FE fire brigade folding door

The "Teckentrup 50" FE fire brigade door fully meets the necessary requirements. In the event of a fire every second is crucial, i.e. all doors must open as quickly as possible after having triggered the alarm. It goes without saying that our doors meet the statutory stipulations for fire brigade folding doors as per DIN 14092-1.



### Folding doors with automatic mode

Particularly in areas subject to high levels of traffic, such as workshops, car wash systems and paintshops an automatically opening door saves plenty of time and energy. Door systems can either be operated using dead man or pulse control. Doors can open towards the inside or outside.



# STEEL FOLDING DOOR

## FE "TECKENTRUP 50"

- DOUBLE-WALLED, HEAT-INSULATED
- EXCELLENT THERMAL INSULATION  $U_d = 1.8 \text{ W/M}^2\text{K}$
- STORM-PROOF UP TO WIND CLASS  $\pm 4$
- ENERGY-SAVING
- OPTIMISED DESIGN

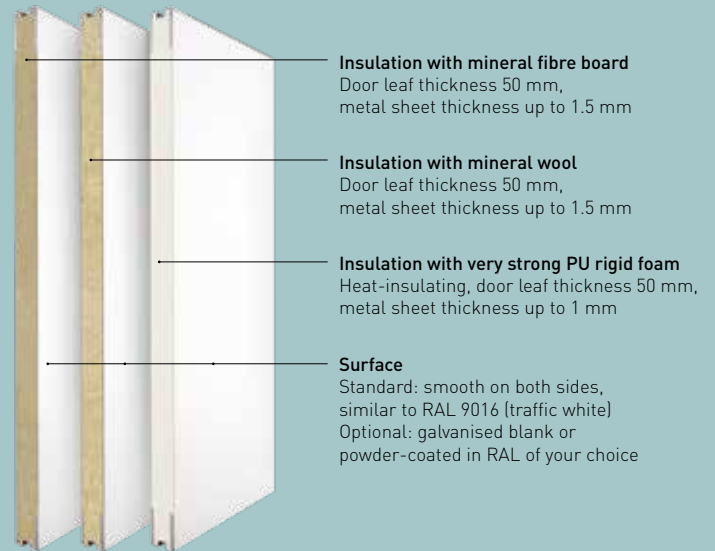

**Insulation with mineral fibre board**  
Door leaf thickness 50 mm,  
metal sheet thickness up to 1.5 mm

**Insulation with mineral wool**  
Door leaf thickness 50 mm,  
metal sheet thickness up to 1.5 mm

**Insulation with very strong PU rigid foam**  
Heat-insulating, door leaf thickness 50 mm,  
metal sheet thickness up to 1 mm

**Surface**  
Standard: smooth on both sides,  
similar to RAL 9016 (traffic white)  
Optional: galvanised blank or  
powder-coated in RAL of your choice

### Installation in

- Masonry
- Concrete
- Autoclaved aerated concrete walls
- Steel designs

### Size range

Width: 2250 – 16000 mm  
Height: 2000 – 5000 mm

### Door leaf

Made of box-type edged steel sheets with all-round mount for EPDM rubber accident profile (GUP). With top and bottom leaf seal and mounting bracket. Door leaf thickness: 50 mm

- Insulation: PU foam  
Surface: primed similar to RAL 9016

Alternatively:

- Insulation: permanently bonded mineral wool, metal sheet thickness: 1.0 mm galvanised  
Surface: primed similar to RAL 9016
- Insulation: mineral wool  
Metal sheet thickness: 1.5 mm galvanised  
Surface: galvanised blank

Metal sheet special equipment:

- 1.0 mm PU foam
- 1.5 mm mineral wool (permanently bonded)

### Surface

Galvanised door leaf featuring coil coating similar to RAL 9016 (traffic white) or galvanised blank. Galvanised door frame.

- Optionally primed powder-coated in RAL of your choice (mineral wool version only)

### Door frame

Lateral frame made of rectangular 50 x 90 mm pipe. Top frame profile with guide rail (U-profile) and relief level. Featuring bottom buffer at the bottom. Installation in soffit.

Special equipment: installation in front of soffit. Possible without bottom buffer. (For leaf coupling  $\geq 4$  leaves units per side require a bottom buffer. On request for large-scale glazing.)

Made of box-type edged steel sheets with all-round mount for EPDM rubber accident profile (GUP). With top and bottom leaf seal and mounting bracket. Door leaf thickness: 50 mm

- Insulation: PU foam  
Surface: primed similar to RAL 9016

Alternatively:

- Insulation: permanently bonded mineral wool, metal sheet thickness: 1.0 mm galvanised  
Surface: primed similar to RAL 9016
- Insulation: mineral wool  
Metal sheet thickness: 1.5 mm galvanised  
Surface: galvanised blank

Metal sheet special equipment:

- 1.0 mm PU foam
- 1.5 mm mineral wool (permanently bonded)
- 1.75 mm mineral wool

### Special equipment

- Black steel/stainless steel hinges
- Door stop/rubber buffer between leaves
- Divided active leaf including buffer seal\*
- Wicket door without threshold including buffer seal\*
- Wicket doors with threshold including buffer seal (not approved for panic exits)
- Wicket door always featuring central end leaf and two security bolts
- Panic lock (latch lever function E)
- Louvres, rain canopy
- Fire brigade release function with pull rope for 2:2 folding method
- Motor with dead man control
- Pulsecontrol for power-operated doors as per EN 12453 (tested design version)

\* (with panic function)



# FIRE BRIGADE FOLDING DOOR

## FE "TECKENTRUP 50"

- 4-LEAF
- WITH QUICK RELEASE SYSTEM USING SPRING FORCE

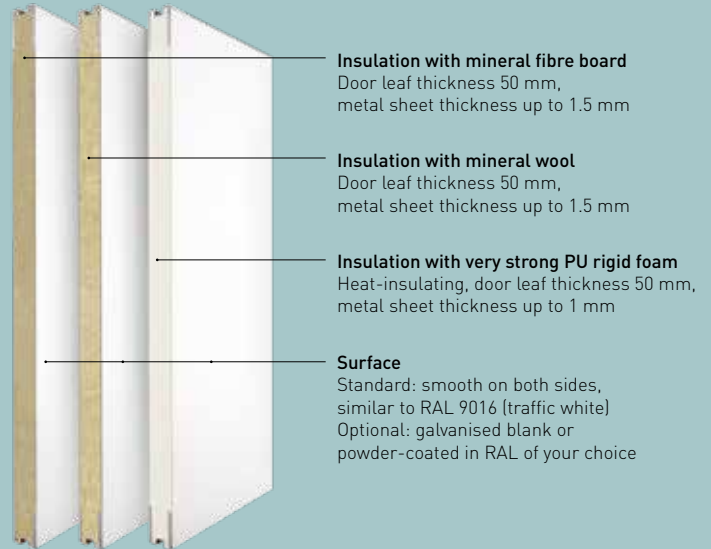

In the event of a fire every second is crucial, i.e. all doors must open as quickly as possible after having triggered the alarm. The FE "Teckentrup 50" folding door is subject to spring force and it is unlocked using a pull rope. The door opens in seconds (without the need for electrical power).

The opening speed can be set individually. The door leaves can also be closed very easily by hand from the outside. No need for convoluted spring tensioning as would be the case with conventional doors.

(Also see page 13 for technical data)



### Release

If the door is released using the pull rope, door leaves automatically swing open.



### Rubber buffers

Absorbs the opening process to consequently protect door leaf and fittings.

### Pull rope

The quick release system is triggered using a pull rope. Its position can be adapted to the circumstances on-site.

# ELECTRICALLY DRIVEN FOLDING DOORS

The FE "Teckentrup 50" folding door (4-leaf, 2:2 coupled, 90° opening angle; alternatively also 2-leaf, 2:0; 0:2 coupled) can be equipped with electric sliding arm drive. This innovative, space-saving door technology meets maximum demands in terms of speed, convenience and cost-efficiency. Particularly in areas subject to high levels of traffic, such as workshops, car wash systems or paintshops an automatically opening door saves plenty of time and energy.



## Reliable and secure

Door systems can either be operated using dead man or pulse control. Doors can open towards the inside or outside. As part of pulse control the unit is secured by a self-monitoring accident protection device at the main closing edge as well as photocells. Anti-clamping profiles on all vertical closing edges additionally protect from injuries.



## Individual electrical drives

Application of two electrical sliding arm drives on the door leaves, featuring sliding arm and security contact strip as well as photocells. The drive housing is supplied in the same colour as the door. Control can be programmed to partial opening of one or both leaves. As standard the wiring is installed on the door leaf (figure on the left shows conduit).

Opening  
speed:  
12 seconds



door inward opening, view from the inside

drive „Entrematic LCU40H“

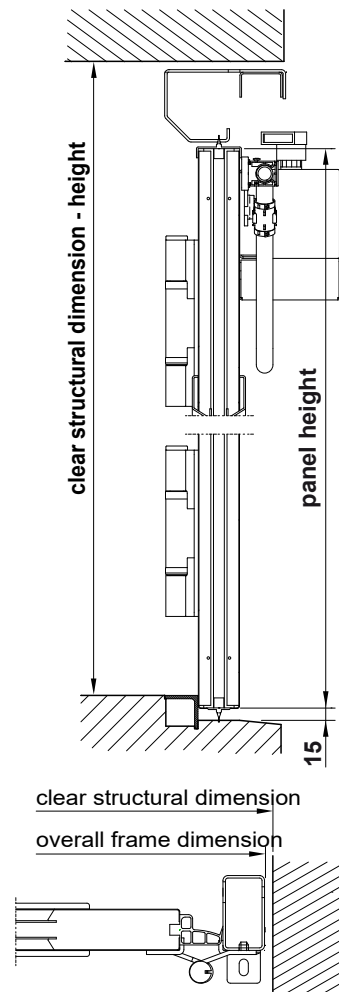
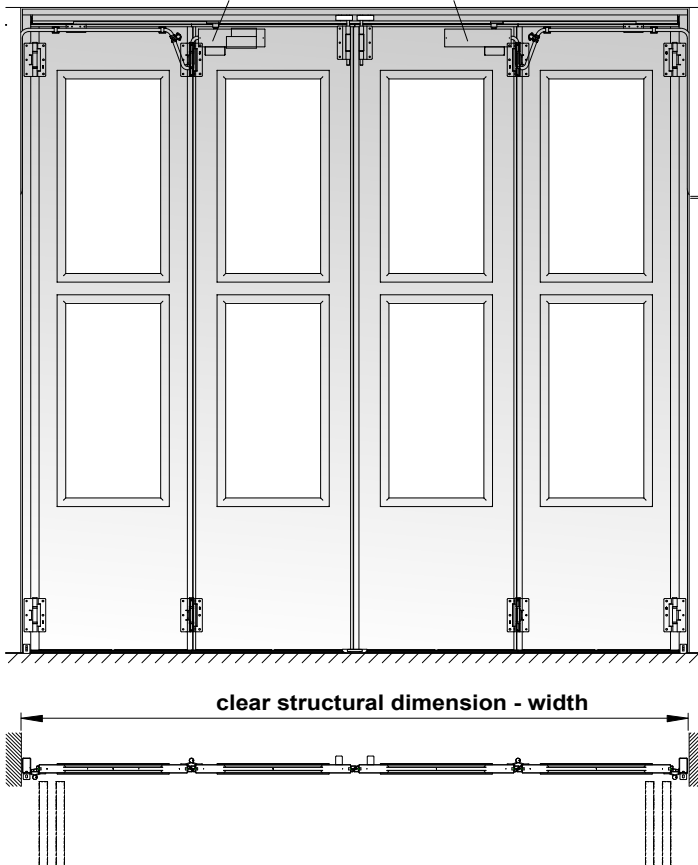

Install rain canopy if opened towards the outside (external drive).  
Manual emergency release is relocated to the inside.

#### Technical information

##### Drive consists of:

- 1 x LCU40H control at all couplings (control as per EN 12453)
- 2 x electromechanical "Ditec Dor 1BHS drive" sliding arm drive including sliding arm, IP 55 (coupling 2:2, opens towards the inside or outside)
- 1 x electromechanical "Ditec Dor 1BHS drive" sliding arm drive including Sliding arm, IP 55 (coupling 2:0 or 0:2, opens towards the inside or outside)
- 1 x Open/Stop/Close button
- 2 x safety contact strip (for coupling 0:2/2:0 only one safety contact strip) (pulse control only)
- 1 x photocells (pulse control only)
- Centre bracket, bottom (1 x with bottom buffer, 2 x without bottom buffer)

##### Special equipment:

- 4-channel handheld transmitter on request
- 2-channel handheld transmitter (40 units per control at max.)
- External 2-channel radio receiver, 868 MHz, IP 65, digital 344 (manual wiring)
- S-APZ 1-2T/1 key switch with PHZ
- J-APZ 4-1 R/2 key switch, Open/Close with stop button, can be locked
- KDT 3 V2 Open/Stop/Closed push button
- Pull switch without bracket
- BEA radar motion sensor
- Second reflection photocell
- Type SL11 signal/flashing light, 24 V, yellow, flashes
- Red/green signal light set/Leuci bulbs
- Control for MS2/3 traffic light system, control unit for oncoming traffic, suitable for use with red/green signal light set
- Digital induction loops including loop wire
- 1-channel (one-sided) ULD 911
- 2-channel (on both sides) ULD 921 (direction recognition possible)



# AESTHETIC APPEARANCE

**There are no shortcomings in the design either:**

Our folding doors are available with a number of designs and furnishings and will match the architectural aesthetics of any building facade.

**Choose from numerous design options:**

Whether it's colours, surfaces, glazing and styling, you will find the right solution that fits your requirements here.

As a result of their appealing, modern styling, for example with chic glazing elements, our folding doors are true eye-catchers within the entire retail park.

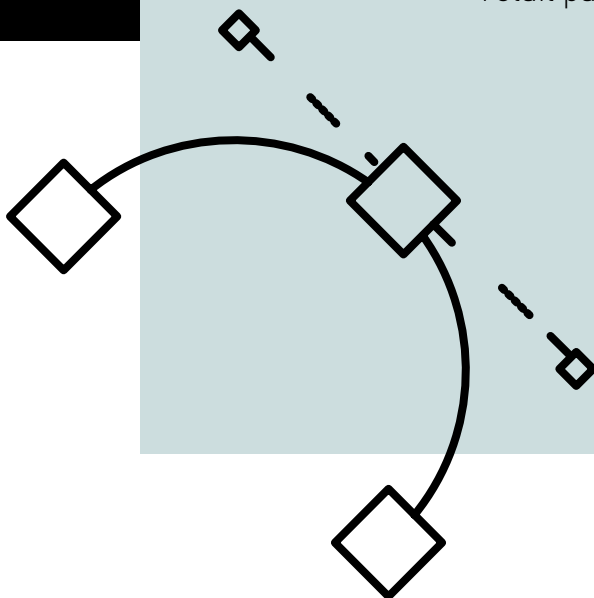

# OUR DESIGN VARIETY CATERS TO EVERY DEMAND

## COLOURS

The look of the door contributes significantly to the appearance of an industrial facility and also perfectly expresses the corporate design. The broad Teckentrup colour spectrum allows for countless door designs. Teckentrup folding doors are galvanised featuring coil coating similar to RAL 9016 (traffic white) or galvanised blank as standard. Optionally also featuring coil coating in RAL of your choice (mineral wool version only).



The brighter the colour, the lower the degree of deformation/strain of the door in direct sunlight.

## GLAZING

Glazing not only lets daylight penetrate the hall, it also provides a view of the outside. Consequently, accidents as a result of poor visibility can be prevented. Plastic or glass single or double glazing is used for folding doors depending on the requirements.



18 mm double glazing, 6 mm laminated safety glass or 21 mm ISO laminated safety glass, with aluminium glass retaining strips.



18 mm double glazing, 6 mm laminated safety glass or 21 mm ISO laminated safety glass, with steel glass retaining strips. New: Category 3 waterproof in heavy rain



6 mm laminated safety glass or 21 mm ISO laminated safety glass, with rubber frame.

## DOOR SOLUTIONS

The divided door leaf allows integration of a door opening for persons across the entire width of the door leaf. Thanks to the application of a push bar or handle this design is also suitable for panic installations. A 4-sided seal guarantees complete, silent closing and simultaneously prevents heat loss.

Alternatively wicket doors with and without thresholds are available with four-sided seals.



Divided door leaf



Wicket door

# DOORS FOR MORE SECURITY

Our folding doors guarantee a high degree of protection and security and are in particular used in large maintenance halls, storage depots, equipment halls or vehicle depots. The robust, flexible and space-saving door design with few parts subject to wear is exceptionally rugged, durable, is almost maintenance-free, and thus highly cost-effective. The use of modern control elements and intelligent accessories ensures additional convenience for daily opening and closing of doors.

- e.g. finger pinch protection
- e.g. lockable basquill
- e.g. screws with pin

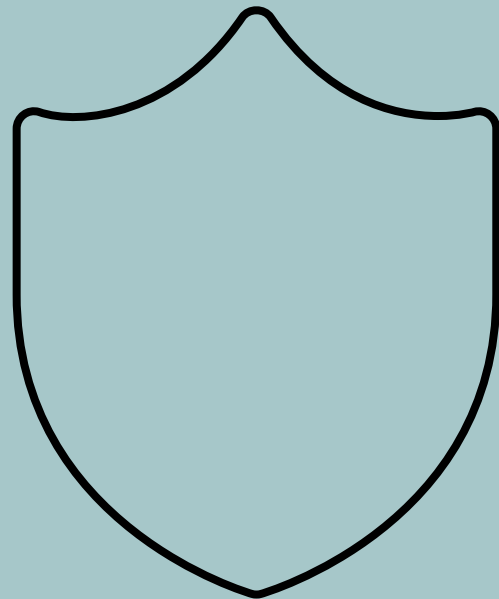



# TECHNOLOGY THAT CONVINCES



Teckentrup folding doors meet valid European security standards as standard. They fulfil EN 13241-1 specifications:

- Mechanical influences
- Integrity
- Heat insulation
- Safety of use
- Wind load
- Sound insulation





### **1** Smooth running characteristics

Doors with up to three leaves per side are guided using only a single castor on the side in the guide rail. Low-wear steel castors guarantee very silent, easy and durable running characteristics.



### **2** Release roller

Depending on the version the door is equipped with a reinforced release roller including guide.



### **3** Easy to operate

The door is securely locked using well designed fittings and spring pretension. The locking bars can be adjusted to enable retrospective adjustment. Robust handles facilitate operation.



### **4** Secured, adjustable hinges

Hinges made of highly strong, galvanised steel have been ideally adapted to the door leaf. Special adjustment screws are used to adjust the leaves at two levels so they are always individually aligned.



### **5** Level door leaf – dampened closing

Individual door leaves are very durable and extremely level. Adjustable rubber dampers are used to ideally align individual leaves with each other to consequently guarantee sealed and silent closing at all times.



### **6** Extremely sealed and durable

The upper seal surrounds the leaf and thus protects it from water damage. The special design of the very strong door leaves does not require welding and thus neither the galvanised layer, nor the priming are tampered with – and this safely protects from corrosion.



### **7** Securely locked door leaves

Folding doors must be secured when open. For this purpose, they can be secured using a drop bolt, fitted on the inside at the bottom. Alternatively: secure the door leaf with a floor-mounted or wall arresting device.



### **8** Frame installation with screw mounting

No welding! Time-saving attachment to masonry using a console that is screwed to the frame and wall. Optionally: decorative plug-on console trim (can be removed if necessary).



### **9** Wicket door without threshold

The visually matching wicket door, without threshold, has been integrated into the door leaf and enables easy access even with small vehicles. The door system remains closed, heat loss is prevented (also for escape routes and emergency access).

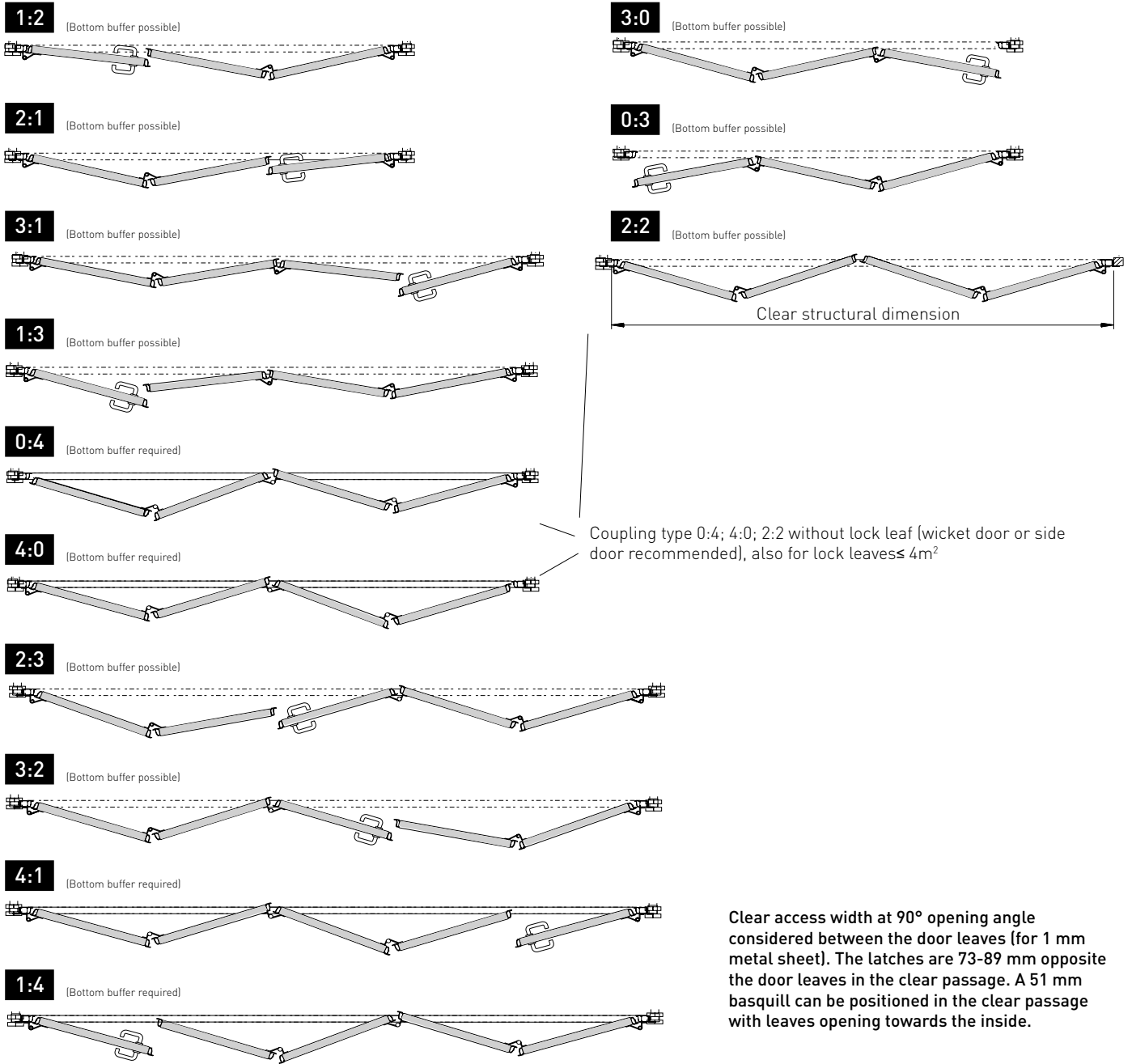

LEAF COUPLING	Clear passage (installed in soffit) At 90 approx.	number of all leaves	Min. RAM width	Max. RAM width	Number of rubber buffers*	Lock leaves
1:2/2:1	Clear structural dimension -424 mm	3	2160	4200	2	■
3:0/0:3	Clear structural dimension -471 mm	3	2114	4274	2	■
1:3/3:1	Clear structural dimension -526 mm	4	2750	5630	4	■
2:2	Clear structural dimension -526 mm	4	2830	5550	4	
0:4/4:0	Clear structural dimension -527 mm	4	2830	5550	6	
2:3/3:2	Clear structural dimension -628 mm	5	3500	6900	6	■
4:1/1:4	Clear structural dimension -628 mm	5	3500	6900	6	■

\*Calculation with lock leaf

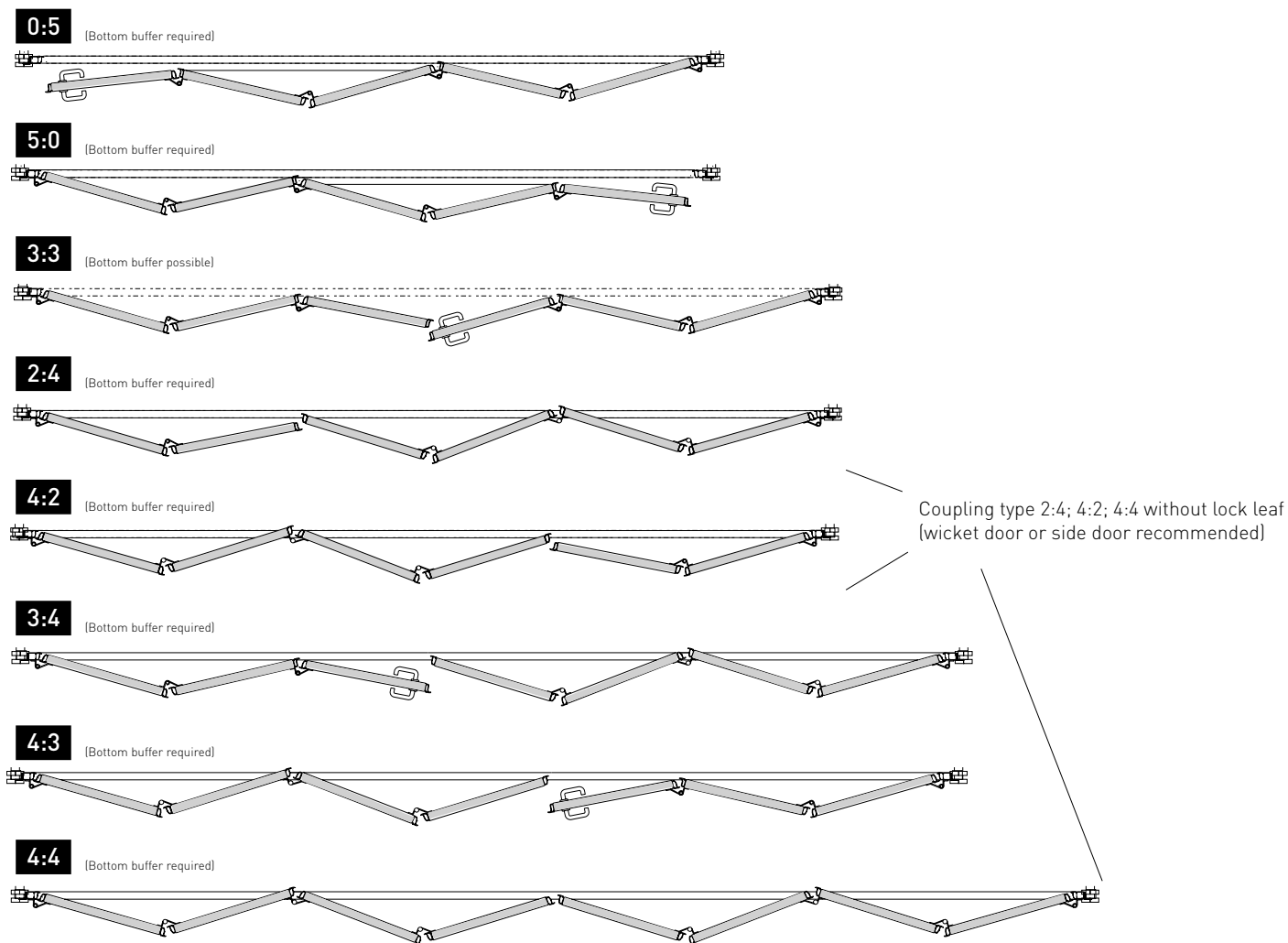

### Additional coupling options:

LEAF COUPLING	Clear passage (installed in soffit) At 90° approx.	number of all leaves	Min. RAM width	Max. RAM width	Number of rubber buffers*	Lock leaves
0:5/5:0	Clear structural dimension - 675 mm	5	3414	7014	8	■
3:3	Clear structural dimension - 730 mm	6	4050	8370	6	■
2:4/4:2/6:0/0:6	Clear structural dimension - 730 mm	6	4170	8250	8	
4:3/3:4	Clear structural dimension - 832 mm	7	4840	9600	8	■
4:4	Clear structural dimension - 934 mm	8	5510	10950	12	
2:0/0:2	Clear structural dimension - 323 mm	2	1490	2850	2	
2:5/5:2/1:6/6:1	Clear structural dimension - 832 mm	7	4840	9600	8	■
3:5/5:3	Clear structural dimension - 934 mm	8	5350	11110	10	■
2:6/6:2	Clear structural dimension - 934 mm	8	5510	10950	10	
3:6/6:3/4:5/5:4	Clear structural dimension - 1036 mm	9	6180	12300	12	■
5:5	Clear structural dimension - 1138 mm	10	6650	13850	14	■
4:6/6:4	Clear structural dimension - 1138 mm	10	6850	13650	14	
5:6/6:5	Clear structural dimension - 1240 mm	11	7520	15000	14	■
6:6	Clear structural dimension - 1342 mm	12	8190	16350	16	

\*Calculation with lock leaf

FE "Teckentrup 50" folding door (installation in and in front of the soffit)

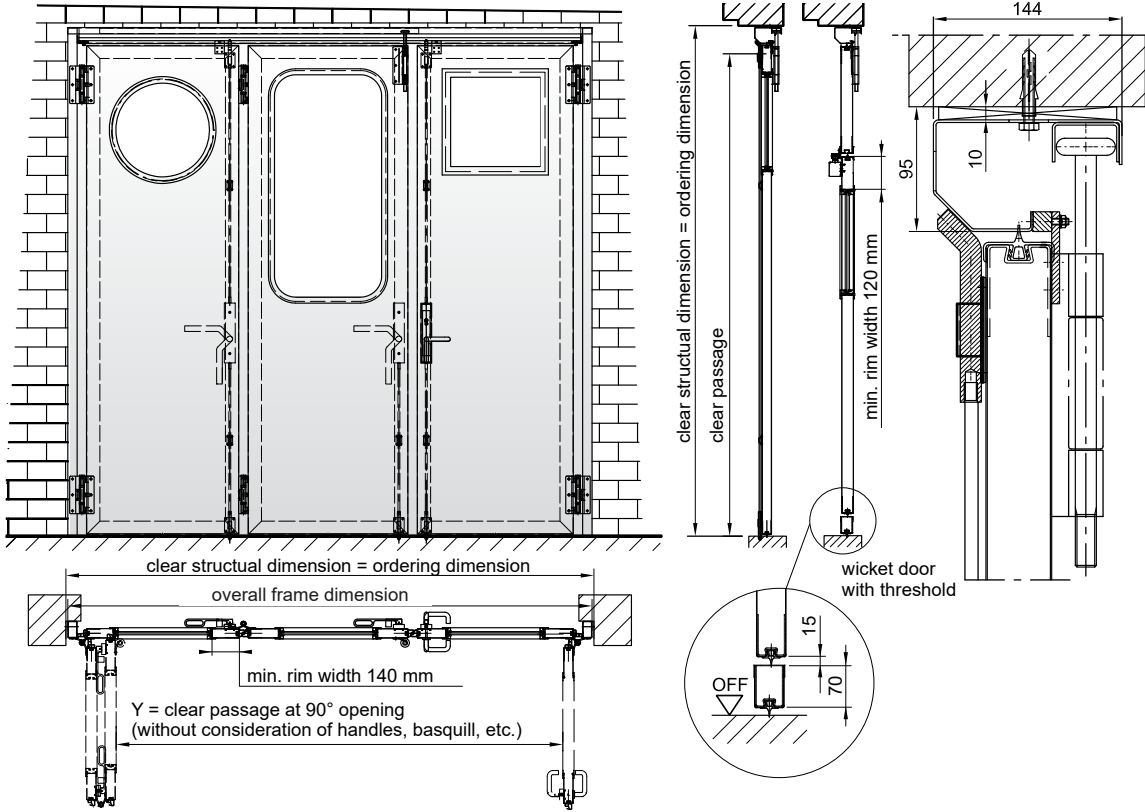

**Installation without headroom** (outward opening shown)  
within and in front of the soffit possible

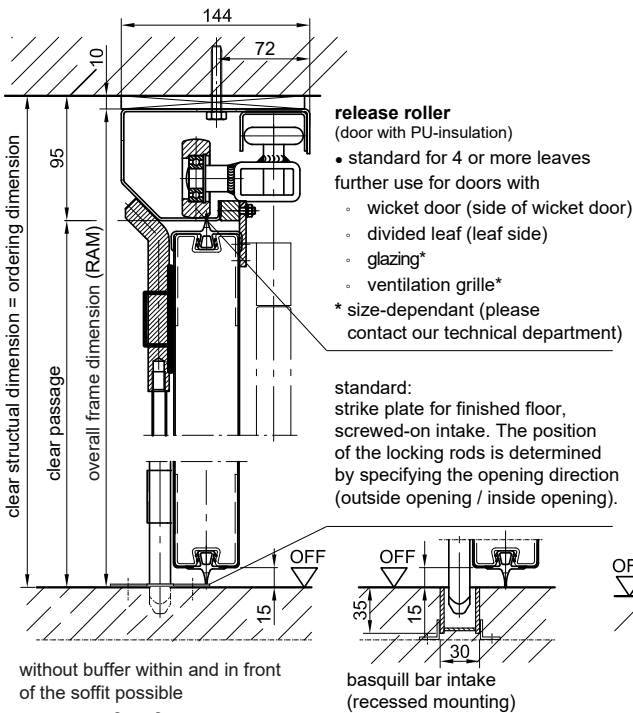

**Installation in front of the soffit**  
(90° outward opening shown)

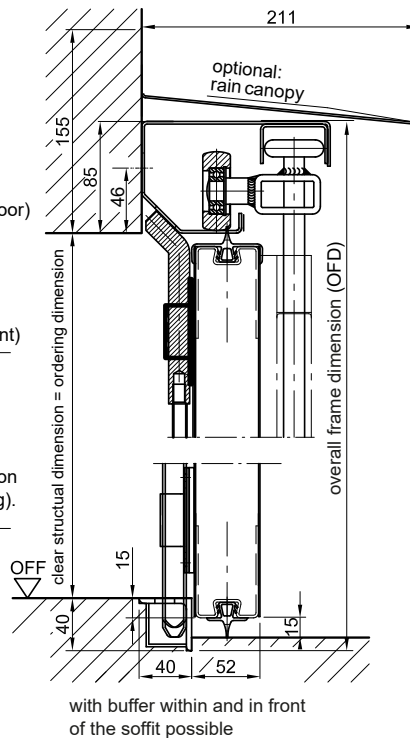

**Installation within the soffit**

clear structural dimension = ordering dimension

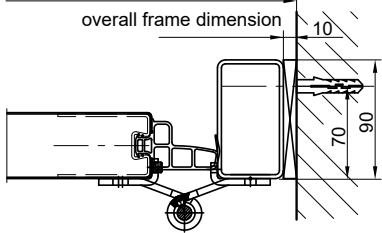

**Installation in front of the soffit, 180° opening**

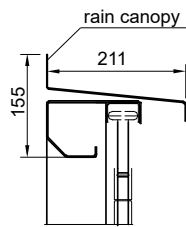

"light version"  
used for door sides  
with 1 guide roller

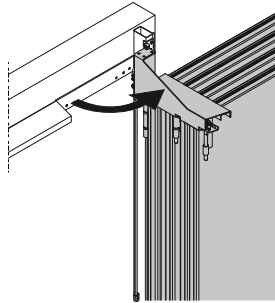

"heavy version"  
used for door sides  
with at least 1 release roller

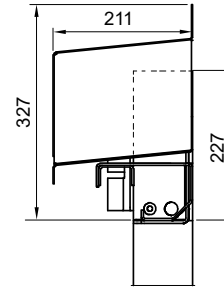

**calculation of dimension X (per side)**

for 180° opening:	leaf	X-dimension
for coupling with 0:	0	= 50/*96
for uneven couplings e.g.:	1; 3; 5	= 104
for even couplings e.g.:	2; 4; 6	= 122
e. g.: coupled 0 : 2 = 50 mm + 122 mm		
coupled 0 : 3 = *96 mm + 104 mm		
coupled 1 : 2 = 104 mm + 122 mm		
* = lock-leaf element 180° opened		

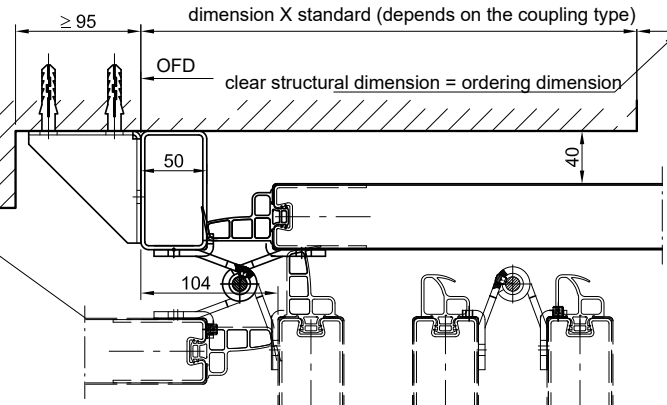

**Installation within the soffit**  
coupled 2 : 1

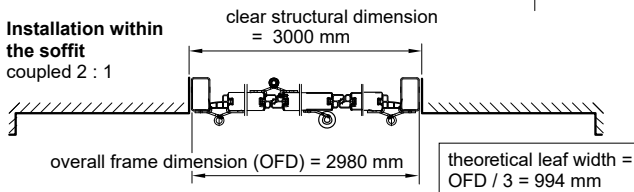

**Installation in front of the soffit**  
coupled 2 : 1

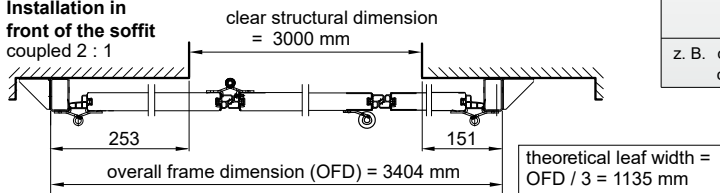

**90° opened**

number of leaves	calculation of dimension X (per side) for 90° opening and sheet thickness		
	bis 1,0 mm:	bis 1,5 mm:	bis 1,75 mm:
von: 0	= 50/96	= 50/96	= 50/96
1	= 151	= 152	= 153
2	= 253	= 255	= 257
3	= 355	= 358	= 361
4	= 457	= 461	= 465
5	= 559	= 564	= 569
6	= 661	= 667	= 673

z. B. coupled 0 : 2: with 1,5 mm sheet thickness = 50 mm + 255 mm  
coupled 0 : 3: with 1,5 mm sheet thickness = 96 mm + 358 mm

**glazing alignment, further alignments possible**

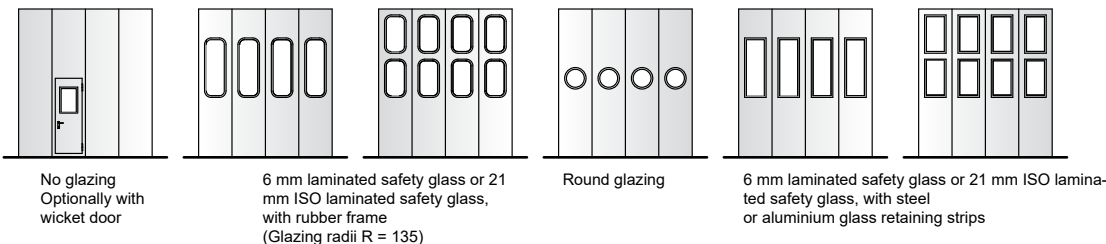

Fire brigade folding door with fire brigade release as per DIN 14092-1

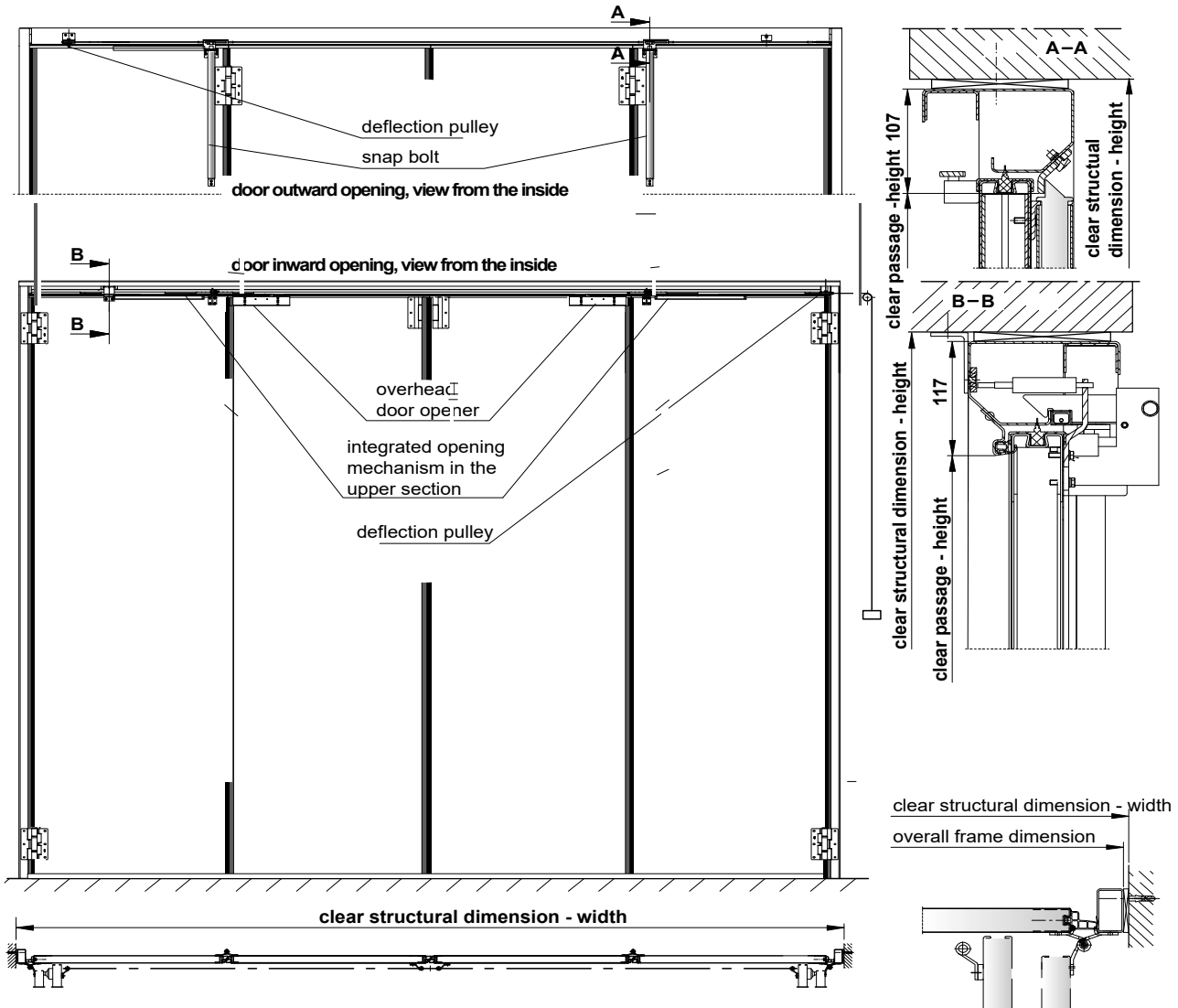

**Fire brigade folding door accessories**

- 1 x pull rope with handle
- 2 x overhead door opener IP 55 (coupling 2:2, opens towards the inside or outside)
- 1 x Gas pressure spring IP 55 (coupling 2:0 or 0:2, opens towards the inside or outside)
- Centre bracket, bottom (1 x for bottom buffer, 2 x without bottom buffer)
- 2 x deflection pulley
- 4 x rubber buffer
- 2 x floor-mounted stop
- 1 x integrated opening mechanism in the upper section

**Technical data**

- Potential couplings 2:2
- Opened using pull rope, manually closed, using catch
- Adjustable opening speed
- 90° opening (180° not possible)
- Opens towards the inside or outside
- Wicket door (version with threshold)

**Technical information**

- Opening speed approx. 6 sec.
- Determined maximum door leaf dimensions for required load capacity Pa of wind classes 1-3:  
 Door surface ≤ 13.2 m<sup>2</sup> with 965Pa load = wind class 3  
 Door surface > 13.2 m<sup>2</sup> ≤ 20.58 m<sup>2</sup> with 620Pa load = wind class 2  
 Door surface > 20.5 m<sup>2</sup> ≤ 30.8 m<sup>2</sup> with 415Pa load = wind class 1

<b>Folding doors</b>			
	<b>FE Teckentrup 50 (manually operated)</b>	<b>FE Teckentrup 50 with drive</b>	<b>FE Teckentrup 50 with fire brigade release</b>
<b>PERFORMANCE CHARACTERISTICS*</b>			
<b>Fire brigade release folding method 2:2 as per DIN 14092-1:2012-04, opens towards the inside/outside</b>	-	-	■/▲
<b>Resistance against wind loads per EN 12424*</b>	Class ± 4 (2500Pa)	Class ± 2	Class ± 3 (≤ 13.2m <sup>2</sup> )
<b>Air permeability (DIN EN 12426) with/without bottom buffer*</b>	Class 3 (<6 m <sup>3</sup> /hm <sup>2</sup> at 50 Pa) Class 4 (<3 m <sup>3</sup> /hm <sup>2</sup> at 50 Pa)	-	-
<b>Heat insulation (DIN EN ISO 12428): U<sub>D</sub> in W/(m<sup>2</sup>K)* (installed 3.5 x 3.5 m door)</b>	PU foam: 1.9 Mineral wool: 1.8 Mineral fibre board 2.0	-	-
<b>Noise insulating (ISO 717-1)*</b>	PU foam: 26 dB Mineral wool: 32 dB	-	-
<b>Water penetration resistance as per EN 12425 with/without bottom buffer*</b>	PU foam: Class 2 (50 Pa), class 3 (120 Pa)	-	-
<b>DOOR SIZES</b>			
<b>Maximum width in mm</b>	16000	4500	5000
<b>Maximum height in mm</b>	5000	4500	5000
<b>ATTACHMENT TYPE</b>			
<b>Installation in the soffit</b>	■	■	■
<b>Installation in front of/behind the soffit</b>	▲	▲	▲
<b>Minimum headroom in mm</b>	85	85	85
<b>Space requirements on the sides</b>	See technical data sheet	See technical data sheet	See technical data sheet
<b>Leaf width in mm</b>	max. 600 - 1320	max. 600 - 1030	max. 600 - 1160
<b>Installation depth in mm</b>	50	50	50
<b>Opening angle 90 or 180 degrees</b>	■/▲	■/-	■/-
<b>DOOR LEAF</b>			
<b>Galvanised metal sheet</b>	■	■	■
<b>Coil coating similar to RAL 9016</b>	■	■	■
<b>Powder-coated RAL of your choice</b>	▲	▲	▲
<b>Hinges: two-part, triple roller steel hinges</b>	■	■	■
<b>Finger pinch protection</b>	■	■	■
<b>WICKET DOOR</b>			
<b>Door height in mm (standard height = 2100 mm)</b>	2100 - 2500	2100 - 2500	2100 - 2500
<b>Door with threshold/without threshold (height)</b>	70 mm /▲	70 mm/-	70 mm/-
<b>DIVIDED LOCK LEAF</b>			
<b>Maximum door height in mm (standard height = 2,100 mm)</b>	2100 - 2500	-	-
<b>FILLINGS</b>			
<b>Mineral fibre board/mineral wool/PU rigid foam</b>	▲/▲/■	▲/▲/■	▲/▲/■
<b>GLAZING TYPES</b>			
<b>18 mm plastic double glazing/scratch-proof</b>	■/▲	■/▲	■/▲
<b>6 mm laminated safety glass/21 mm ISO laminated safety glass</b>	▲/▲	▲/▲	▲/▲
<b>Rounded corners with rubber frame (for laminated safety glass only)</b>	▲	▲	▲
<b>Aluminium GL/steel GL/secured steel GL (GL = glass retaining strips)</b>	▲/■/▲	▲/■/▲	▲/■/▲
<b>GLAZING SHAPES</b>			
<b>Rectangular (dimensions on request)</b>	■	■	■
<b>Square (dimensions on request)</b>	■	■	■
<b>Round (dimensions on request)</b>	▲	▲	▲
<b>ATTACHES TO</b>			
<b>concrete, steel, masonry</b>	■	■	■
<b>Autoclaved aerated concrete walls</b>	▲	▲	▲

\*The achieved classes depend on the door models and equipment.



DESIGN | SECURITY | SERVICE

Professional solutions

We provide customised solutions for your individual requirements. With our door solutions, you can count on more design, security and service.

[WWW.TECKENTRUP.CO.UK](http://WWW.TECKENTRUP.CO.UK)

We are happy to help.

Tel: 01933 448 850

**TECKENTRUP**  
DOOR SOLUTIONS  
[www.samsondoors.co.uk](http://www.samsondoors.co.uk)