

# Teckentrup Security Doors Brochure



EMAIL: [ENQUIRIES@SAMSONDOORS.CO.UK](mailto:ENQUIRIES@SAMSONDOORS.CO.UK)  
TELEPHONE: (01933) 448850  
MON - FRI 8:00AM - 5:00PM

**TECKENTRUP** | PROFESSIONAL

# THE SECURITY DOORS

Teckentrup security doors for all cases



**TECKENTRUP**  
DOOR SOLUTIONS



## Heavy-Duty - Security

Solutions for all Sectors

Pages 04 - 11

## Steel Security doors

"Teckentrup" 62-1/2 SECURE 1

Pages 12 - 13

"Teckentrup" 62-1/2 SECURE 2

Pages 14 - 15

"Teckentrup" 62-1/2 SECURE 3

Pages 16 - 17

"Teckentrup" 62-1/2 SECURE 3+

Pages 18 - 19

"Teckentrup" 62-1/2 SECURE 4

Pages 20 - 21

"Teckentrup" 62-1/2 SECURE A

Pages 22 - 23

"Teckentrup" 62-1/2 SECURE B

Pages 24 - 25

## Design and Installation

For your individual demands

Page 26

Installation Options

Page 27

Technical data

Page 31

MADE  
IN  
GERMANY

# TECKENTRUP DOOR SOLUTIONS

Whether it's development, production or distribution, whether it's about the entire whole or about a small detail, for us, everything revolves around the decisive question: **WHAT IS THE SOLUTION FOR YOU?**

Because we are the specialist for fire protection, smoke protection, sound insulation and security doors, for industrial sectional doors, rolling shutters, folding doors, sliding doors and garage doors.

And we are **"Made in Germany"**. For more than 80 years, we have developed and produced our products exclusively in Germany. More than 900 employees at our locations in Verl and Großzöberitz create our high-quality products for you. All processes, from supply to production to commissioning and delivery, are based on the DIN EN ISO 9001 quality management system.

# COMPREHENSIVE SERVICE

**We provide custom solutions and comprehensive service to our customers, from project planning to installation to operating our products. Take a look for yourself.**

## CROSSRAIL RAILWAY STATIONS, LONDON

Crossrail is the new high frequency, high capacity railway for London and the South East. The Elizabeth line will run from Reading and Heathrow in the west, through 42km of new tunnels under London to Shenfield and Abbey Wood in the east. Expected to serve around 200 million passengers a year, the railway will have 41 stations, of which, 10 are newly built and 30 upgraded.

In this large project Teckentrup supplied the steel doorsets for the railway stations Whitechapel, Liverpool Street Station, Farringdon, & Bond Street.

The key aspects of the project were providing compliant, certified product at large sizes that met the complex specification of pressure, fire, acoustics and security in a single product and the twin door solution development for the extreme acoustic requirements. Overcoming design challenges to achieve the right solution alongside managing the project at such a complex site were further noteworthy achievements.





## AHAUS POLICE STATION

Very robust against “mechanical impacts”, quick to lock, with a hatch and the option of looking into the entire cell from the outside - the requirements profile for a cell door is rather complex. The police station in Ahaus (North Rhine-Westphalia) shows how such high requirements are fulfilled. Since the summer of 2014, the 40,000-head municipality of Ahus on the German/Netherlands border has had a new police station.

The three-storey clinker construction is not only headquarters but also prison cells, and therefore rooms that mean unusual demands on doors: First, the construction elements have to be particularly robust. For that reason, the fitting technology, for instance, is made of robust stainless steel. As protection from the sudden opening of the door, a protection chain is used, and a quick-action lock with a sliding bolt is included in the equipment.

It is also important to be able to look into the cell. Instead of the cumbersome video technology, a spy hole is integrated in the door leaf in Ahaus to this end. The guards therefore have a 175-degree view of the cells. For the cases in which the door is not to be opened at all and the imprisoned person nevertheless needs to be looked after, the “communication hatch” is intended.







Burglary-resistant  
in accordance with  
ENV 1627/EN 1627  
EN1522  
LPS 1175/LPS 2081

# HEAVY-DUTY – SECURITY STEEL SECURITY DOORS AND DOORSETS

**Security and aesthetics are not mutually exclusive. Teckentrup insulated 62mm steel doorsets are heavy-duty products suitable for high traffic and exposed external, high wind locations, yet combine high grade design aesthetics.**

At first sight, they seem rather innocuous. But when push comes to shove, they perform. And even resist armed assailants. This makes our security doors suitable for all risk areas. Our prison cell doors and bullet-proof doors top off our range in the area of danger protection.

## **Core Performance Characteristics**

- EN1627 to RC4, LPS 1175 to SR4 Security Rating D10, LPS 2081 to Security Rating B
- Openings up to 4000mm x 4000mm
- Ballistic and prison versions available
- Polyester Powder Coat finishes in any RAL colour
- Available in a stainless-steel construction and with vision panel options
- Louvre Options
- 108 locking variants for single or multipoint, mechanical, electromechanical and access control locking
- Panic bars and push pads
- 52 cylinder variants
- Alarm contacts
- Vision panels
- Multiple frame profiles





# TECHNICALLY PERFECT – SOLUTIONS FOR ALL SECTORS

## SECURITY HARDWARE PERFORMANCE

Steel security rated doors are designed to withstand physical attack for varying periods of time, with a variety of attack tools. The longer the attack time, and the more aggressive the tools used, the higher the doors' performance rating.

They do not look unusual at first glance, but they are there when things get tough. And they can even keep armed intruders out. Our security doors are thus suitable for all high-risk areas. Our prison cell doors complete our range of doors for risk prevention..

Emergency Exit as  
per EN179

Panic Exit as per  
EN1125

### Uses

- Security rooms in airports and train stations
- Police stations
- Banks, financial institutions
- Court buildings
- Safe rooms
- Police sections at large venues
- Private buildings with high security requirements (including ballistic)
- Prisons and correctional facilities



**Teckentrup steel fire doors and doorsets have been tested to:**

- European Security Standard EN1627 achieving RC2, RC3 & RC4 ratings
- Exova Security Standard STS202 achieving BR1, BR2 & BR3 ratings
- LPS 1175 Security rating A1-D10
- LPS 2081 Security rating A + B
- EN1634-1 achieving 120 minutes fire integrity and 60 minutes fire insulation
- European Standards EN1628 & 1629 for static and dynamic loading
- ISO12567-1 achieving a UD value of 1.1 W/m<sup>2</sup>/K°
- EN12207 for air permeability achieving Class 2/4\* for a single and Class 1/3\* for a double leaf door \* Single point/Multi-point locking
- EN12208 for water tightness achieving Class 7A for a single and Class 6A for a double leaf door
- EN12210 for wind resistance achieving Class 3/5 for a single and Class 1/3 for a double leaf door
- A 62mm insulated door set, fitted with heavy duty 'KO' hinges has been tested to EN1191 for repeated opening and closing to C5 level – 200,000 cycles
- Pressure Load as per EN 12211





# SMART AND MODULAR

The modular system of the  
Teckentrup 62 doors.

## **Fives steps to your objective**

Our 62er modular system has 400,000 combinations for you. However, what is more important is that all of your needs are met: Your dream door. The path there is very simple. First, you define the application area and the associated functionality, such as fire protection. Then we move on to the checklist: How is the rebate to be structured? What type of wall are we working with? What frame best fits your spatial situation? And last but not least: What special equipment is desired?

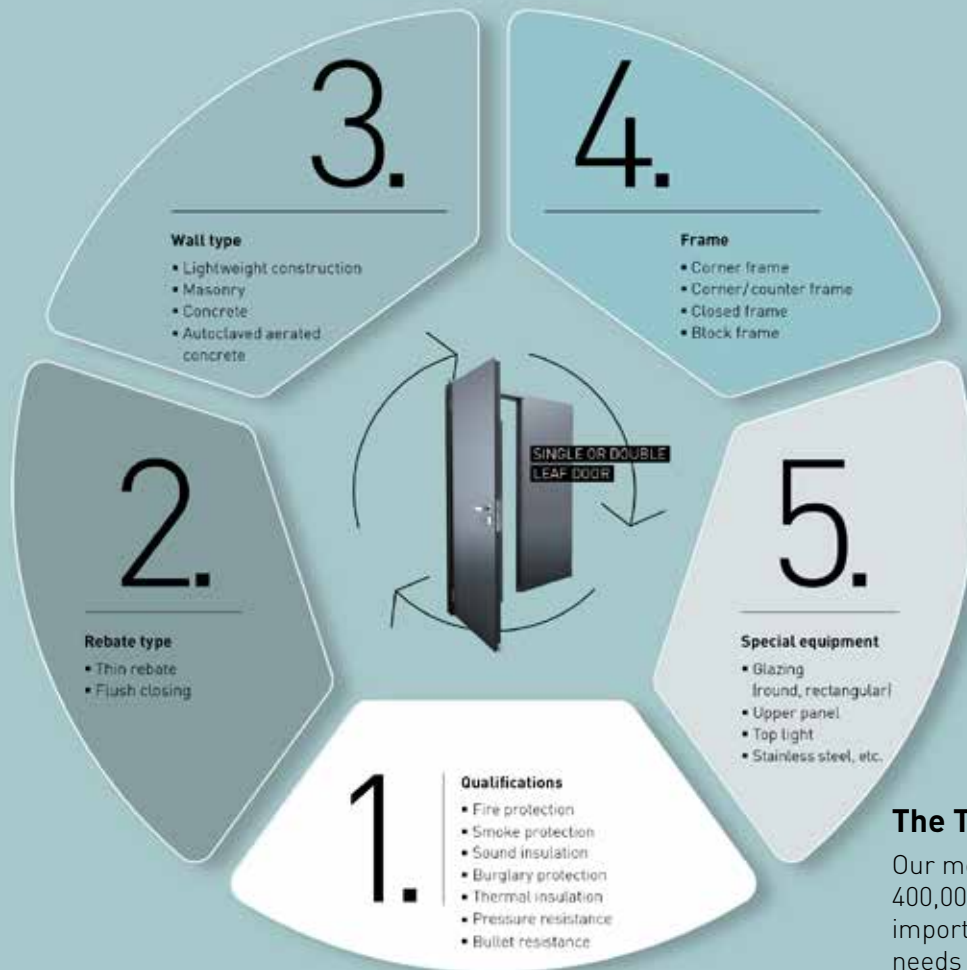

**The Teckentrup 62 modular system**

Our modular system gives you more than 400,000 possible combinations. But most important is the one that meets all your needs - your ideal door.

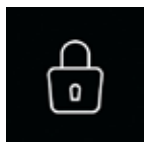

LPS 1175 Issue 8 Security Rating A1 (SR1) to D10 (SR4) LPS 2081 Security Rating A + B



BS EN 12211 pressure 7000Pa max

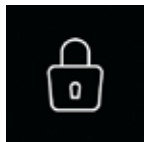

BS EN 1627-1 Security rating RC2, RC3, RC4



BS EN ISO 12567-1 achieving a UD value of 1.1 W/m2/K°



BS EN 1522 Bullet proof rating FB4



BS EN 179 & BS EN 1125 Panic functions



BS EN 1634-1 achieving 120 minutes fire integrity and 60 minutes fire insulation

BS EN 12207 for air permeability achieving Class 2/4\* for a single and Class 1/3\* for a double leaf door \* Single point/Multi-point locking



BS EN 1634-3 Smoke protection S<sub>a</sub> / S<sub>200</sub>

BS EN 12208 for water tightness achieving Class 7A for a single and Class 6A for a double leaf door



BS EN 10140 / EN 717 rating up to 44dB

BS EN 12210 for wind resistance achieving Class 3/5 for a single and Class 1/3 for a double leaf door

A Teckentrup 62 insulated door set, fitted with heavy duty 'KO' hinges has been tested to BS EN 1191 for repeated opening and closing to C5 level - 200,000 cycles

All parameters subject to size restrictions and may require special equipment.



# STEEL SECURITY DOOR

## "TECKENTRUP" 62-1/2 SECURE 1

- 1- AND 2-LEAF
- THIN REBATE
- ALSO IN STAINLESS STEEL
- FOR INDOOR USE
- THERMAL INSULATION 1-LEAF: UD = 1,6 W/(m<sup>2</sup>k) / 2-LEAF: UD = 1,8 W/(m<sup>2</sup>k)

### Size range

Modular dimension, 1-leaf:

Width: 500 – 1375 mm

Height: 500 – 2500 mm

Modular dimension, 2-leaf:

Width: 1000 – 2500 mm

Height: 500 – 2500 mm

### Installation in

- Masonry, min. 115 mm
- Concrete, min. 100 mm
- Clad steel and wooden supports F60

### Additional equipment

Fire resistant up to EI<sub>2</sub>30

Sound insulation:

- 1-leaf: 44dB max. 1375 x 2500 mm

Sound insulation:

- 2-leaf: 38dB max. 2750 x 2750 mm

Pressure load:

- up to max. 2000/1200 Pa<sup>2)</sup>  
(single leaf/double leaf)

### Door leaf

- Double-skinned (thin rebate)
- Door rebated on 3 sides
- Door leaf thickness: 62 mm
- Panel thickness: 1.0 mm
- Security bolt: per leaf at least 1

### Surface

Door leaf and frame galvanised, powder-coated and primed

### Frame

- Corner frame, 2.0 mm thick
- Door 3-leaf with circumferential seal
- Counter frame attached with exposed masonry installation
- Block frame

### Special frame equipment

Counter frame, U frame or block frame

### Special equipment

- Top door closer as per EN 1154
- Anti-panic function pursuant to EN179
- Anti-panic function pursuant to EN 1125 (double panic)



**Fire-resistant**  
as per EN 1634-1  
(DIN 4102)



**Sound-insulated**  
as per EN 10140/  
EN 717-1 up to  
RW 44 dB<sup>1)</sup>



**Burglary-resistant**  
as per EN1627-1  
according to LPS 1175  
Issue 8 Security  
Rating A1

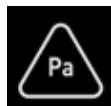

**Pressure-resistant**  
as per BS EN 12211  
pressure 2000 Pa max







# STEEL SECURITY DOOR

## "TECKENTRUP" 62-1/2 SECURE 2

- BULLET-PROOF AS PER DIN EN 1522 (FB4)
- THIN REBATE
- ALSO IN STAINLESS STEEL
- FOR INDOOR USE
- THERMAL INSULATION 1-LEAF: UD = 1,6 W/(m<sup>2</sup>k) / 2-LEAF: UD = 1,8 W/(m<sup>2</sup>k)

### Size range

Modular dimension, 1-leaf:

Width: 500 – 1500 mm

Height: 2000 – 3000 mm

Modular dimension, 2-leaf:

Width: 1284 – 3000 mm

Height: 1967 – 3000 mm

### Installation in

- Masonry, min. 115 mm
- Concrete, min. 100 mm
- Clad steel and wooden supports F60

### Additional equipment

Fire resistant up to E<sub>l</sub> 90

Sound insulation:

- 1-leaf: 37dB max. 3000 x 3000 mm

Sound insulation:

- 2-leaf: 38dB max. 3000 x 3000 mm

Pressure load:

- up to max. 2000/1200 Pa<sup>2)</sup>  
(single leaf/double leaf)

### Door leaf

- Double-skinned (thin rebate)
- Door rebated on 3 sides
- Door leaf thickness: 62 mm
- Panel thickness: 1.0 mm
- Security bolt: per leaf at least 1

### Surface

Door leaf and frame galvanised, powder-coated and primed

### Frame

- Corner frame, 2.0 mm thick
- Door 3-leaf with circumferential seal
- Counter frame attached with exposed masonry installation
- Block frame

### Special frame equipment

Counter frame, U frame or block frame

### Special equipment

- Installed with Mico Tindall security lock (double leaf)
- Installed with KFV security lock (single leaf)
- Three point locking system on single and double leaf
- Top door closer as per EN 1154
- Anti-panic function pursuant to EN179
- Anti-panic function pursuant to EN 1125 (double panic)



**Fire-resistant**  
as per EN 1634-1  
(DIN 4102)



**Sound-insulated**  
as per EN 10140/  
EN 717-1 up to  
RW 38 dB<sup>1)</sup>



**Burglary-resistant**  
as per EN1627-1  
according to LPS 1175  
Issue 8 Security  
Rating A1

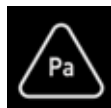

**Pressure-resistant**  
as per BS EN 12211  
pressure 2000 Pa max



# STEEL SECURITY DOOR

## "TECKENTRUP" 62-1/2 SECURE 3

- BULLET-PROOF AS PER DIN EN 1522 (FB4)
- THIN REBATE
- ALSO IN STAINLESS STEEL
- FOR INDOOR USE
- THERMAL INSULATION 1-LEAF: UD = 1,6 W/(m<sup>2</sup>k) / 2-LEAF: UD = 1,8 W/(m<sup>2</sup>k)

### Size range

Modular dimension, 1-leaf:

Width: 500 – 1500 mm  
Height: 2000 – 4167 mm

Modular dimension, 2-leaf:

Width: 1000 – 4134 mm  
Height: 2000 – 4167 mm

### Installation in

- Masonry, min. 115 mm
- Concrete, min. 100 mm
- Clad steel and wooden supports F60

### Additional equipment

Fire resistant up to EI<sub>2</sub>60 / E120 (Certifier)

Sound insulation:

- 1-leaf: 42dB max. 1500 x 3000 mm;  
41dB max. 1750 x 3500 mm

Sound insulation:

- 2-leaf: 41dB max. 3000 x 3000 mm;  
40dB max. 3750 x 3750 mm

Pressure load:

- up to 7000 Pa max<sup>2)</sup>

### Door leaf

- Double-skinned (thin rebate)
- Door rebated on 3 sides
- Door leaf thickness: 62 mm
- Panel thickness: 1.0 mm

### Surface

Door leaf and frame galvanised, powder-coated and primed

### Frame

- Corner frame, 2.0 mm thick
- Door 3-leaf with circumferential seal
- Counter frame attached with exposed masonry installation
- Block frame attached with special SR3 fastenings with M12 VA cylinder head screw

### Special frame equipment

Counter frame, U frame or block frame

### Special equipment

- Installed with Mico Tindall security locking system
- Installed with Surelock McGill security locking system
- Up to five point locking system
- Top door closer as per EN 1154
- Anti-panic function pursuant to EN179
- Anti-panic function pursuant to EN 1125 (double panic)



**Fire-resistant**  
as per EN 1634-1  
(DIN 4102)



**Sound-insulated**  
as per EN 10140/  
EN 717-1 up to  
RW 42 dB<sup>1)</sup>



**Burglary-resistant**  
according to LPS 1175  
Issue 7 Security  
Rating 3<sup>1)</sup>

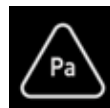

**Pressure-resistant**  
as per BS EN 12211  
pressure 7000Pa max



# STEEL SECURITY DOOR

## "TECKENTRUP" 62-1/2 SECURE 3+

- BULLET-PROOF AS PER DIN EN 1522 (FB4)
- THIN REBATE
- ALSO IN STAINLESS STEEL
- FOR INDOOR USE
- THERMAL INSULATION 1-LEAF: UD = 1,6 W/(m<sup>2</sup>k) / 2-LEAF: UD = 1,8 W/(m<sup>2</sup>k)

### Size range

Modular dimension, 1-leaf:

Width: 500 – 1500 mm

Height: 2000 – 4167 mm

Modular dimension, 2-leaf:

Width: 1000 – 4134 mm

Height: 2000 – 4167 mm

### Installation in

- Masonry, min. 115 mm
- Concrete, min. 100 mm
- Clad steel and wooden supports F60

### Additional equipment

Fire resistant up to EI<sub>2</sub>60 / E 120  
(Certifier)

Sound insulation:

- 1-leaf: 42dB max. 1500 x 3000 mm;  
41dB max. 1750 x 3500 mm

Sound insulation:

- 2-leaf: 41dB max. 3000 x 3000 mm;  
40dB max. 3750 x 3750 mm

Pressure load:

- up to 7000 Pa max<sup>2)</sup>

### Door leaf

- Double-skinned (thin rebate)
- Door rebated on 3 sides
- Door leaf thickness: 62 mm
- Panel thickness: 1.0 mm

### Surface

Door leaf and frame galvanised, powder-coated and primed

### Frame

- Corner frame, 2.0 mm thick
- Door 3-leaf with circumferential seal
- Counter frame attached with exposed masonry installation
- Block frame attached with special SR3 fastenings with M12 VA cylinder head screw

### Special frame equipment

Counter frame, U frame or block frame

### Special equipment

- Installed with Mico Tindall security locking system
- Installed with Surelock McGill security locking system
- Up to five point locking system
- Top door closer as per EN 1154
- Anti-panic function pursuant to EN179
- Anti-panic function pursuant to EN 1125 (double panic)



**Fire-resistant**  
as per EN 1634-1  
(DIN 4102)



**Sound-insulated**  
as per EN 10140/  
EN 717-1 up to  
RW 42 dB<sup>1)</sup>

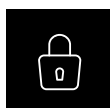

**Burglary-resistant**  
according to LPS 1175  
Issue 7 Security  
Rating 3<sup>1)</sup>

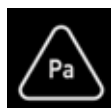

**Pressure-resistant**  
as per BS EN 12211  
pressure 7000Pa max



# STEEL SECURITY DOOR

## "TECKENTRUP" 62-1/2 SECURE 4

- BULLET-PROOF AS PER DIN EN 1522 (FB4)
- THIN REBATE
- ALSO IN STAINLESS STEEL
- FOR INDOOR USE
- THERMAL INSULATION 1-LEAF: UD = 1,6 W/(m<sup>2</sup>k) / 2-LEAF: UD = 1,8 W/(m<sup>2</sup>k)

### Size range

Modular dimension, 1-leaf:

Width: 500 – 1500 mm

Height: 2000 – 4167 mm

Modular dimension, 2-leaf:

Width: 1000 – 4134 mm

Height: 2000 – 4167 mm

### Installation in

- Masonry, min. 115 mm
- Concrete, min. 100 mm
- Clad steel and wooden supports F60

### Additional equipment

Fire resistant up to EI<sub>2</sub>60 / E 120 (Certifier)

Sound insulation:

- 1-leaf: 42dB max. 1500 x 3000 mm;  
41dB max. 1750 x 3500 mm

Sound insulation:

- 2-leaf: 41dB max. 3000 x 3000 mm;  
40dB max. 3750 x 3750 mm

Pressure load:

- up to max 7000 Pa<sup>1)</sup>

### Door leaf

- Double-skinned (thin rebate)
- Door rebated on 3 sides
- Door leaf thickness: 62 mm
- Panel thickness: 1.0 mm or 1.5 mm

### Surface

Door leaf and frame galvanised, powder-coated and primed

### Frame

- Corner frame, 2.0 mm thick
- Door 3-sided with circumferential seal
- Counter frame attached with exposed masonry installation
- Block frame attached with special SR3 fastenings with M12 VA cylinder head screw

### Special frame equipment

Counter frame, U frame or block frame

### Special equipment

- Installed with Mico Tindall security locking system
- Installed with Surelock McGill security locking system
- Up to five point locking system
- Top door closer as per EN 1154
- Anti-panic function pursuant to EN179
- Anti-panic function pursuant to EN 1125 (double panic)



**Fire-resistant**  
as per EN 1634-1  
(DIN 4102)



**Sound-insulated**  
as per EN 10140/  
EN 717-1 up to  
RW 42 dB<sup>1)</sup>



**Burglary-resistant**  
according to LPS 1175  
Issue 8 Security  
Rating D10<sup>1)</sup>

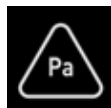

**Pressure-resistant**  
as per BS EN 12211  
pressure 7000Pa max





# STEEL SECURITY DOOR

## "TECKENTRUP" 62-1/2 SECURE A

- THIN REBATE
- ALSO IN STAINLESS STEEL
- FOR INDOOR USE
- THERMAL INSULATION 1-LEAF: UD = 1,6 W/(m<sup>2</sup>k) / 2-LEAF: UD = 1,8 W/(m<sup>2</sup>k)

### Size range

Modular dimension, 1-leaf:

Width: 500 – 1375 mm

Height: 500 – 2500 mm

Modular dimension, 2-leaf:

Width: 1000 – 2500 mm

Height: 500 – 2500 mm

### Installation in

- Masonry, min. 115 mm
- Concrete, min. 100 mm
- Clad steel and wooden supports F60

### Additional equipment

Fire resistant up to EI<sub>2</sub>60 / E120

Sound insulation:

- 1-leaf: 44dB max. 1375 x 2500 mm

Sound insulation:

- 2-leaf: 38dB max. 2750 x 2750 mm

Pressure load:

- up to max 2000/1200 Pa<sup>2)</sup>  
(single leaf /double leaf)

### Door leaf

- Double-skinned (thin rebate)
- Door rebated on 3 sides
- Door leaf thickness: 62 mm
- Panel thickness: 1.0 mm
- Security bolt: per leaf at least 1

### Surface

Door leaf and frame galvanised, powder-coated and primed

### Frame

- Corner frame, 2.0 mm thick
- Door with 3-sided circumferential seal
- Counter frame attached with exposed masonry installation
- Block frame

### Special frame equipment

Counter frame, U frame or block frame

### Special equipment

- Top door closer as per EN 1154
- Anti-panic function pursuant to EN179
- Anti-panic function pursuant to EN 1125 (double panic)



**Fire-resistant**  
as per EN 1634-1  
(DIN 4102)



**Sound-insulated**  
as per EN 10140/  
EN 717-1 up to  
RW 44 dB<sup>1)</sup>



**Burglary-resistant**  
according to LPS 2081  
Issue 1 Security  
Rating A<sup>1)</sup>

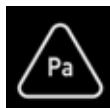

**Pressure-resistant**  
as per BS EN 12211  
pressure 2000Pa max



# STEEL SECURITY DOOR

## "TECKENTRUP" 62-1/2 SECURE B

- BULLET-PROOF AS PER DIN EN 1522 (FB4)
- THIN REBATE
- ALSO IN STAINLESS STEEL
- FOR INDOOR USE
- THERMAL INSULATION 1-LEAF: UD = 1,6 W/(m<sup>2</sup>k) / 2-LEAF: UD = 1,8 W/(m<sup>2</sup>k)

### Size range

Modular dimension, 1-leaf:

Width: 500 – 1500 mm

Height: 2000 – 3000 mm

Modular dimension, 2-leaf:

Width: 1000 – 3000 mm

Height: 2000 – 3000 mm

### Installation in

- Masonry, min. 115 mm
- Concrete, min. 100 mm
- Clad steel and wooden supports F60

### Additional equipment

Fire resistant up to EI<sub>2</sub>90

Sound insulation:

- 1-leaf: 37dB max. 3000 x 3000 mm

Sound insulation:

- 2-leaf: 38dB max. 3000 x 3000 mm

Pressure load:

- up to max 2000/1200 Pa<sup>1)</sup>  
(single leaf /double leaf)

### Door leaf

- Double-skinned (thin rebate)
- Door rebated on 3 sides
- Door leaf thickness: 62 mm
- Panel thickness: 1.0 mm
- Security bolt: per leaf at least 1

### Surface

Door leaf and frame galvanised, powder-coated and primed

### Frame

- Corner frame, 2.0 mm thick
- Door with 3-sided circumferential seal
- Counter frame attached with exposed masonry installation
- Block frame

### Special frame equipment

Counter frame, U frame or block frame

### Special equipment

- Installed with Mico Tindall security lock (double leaf)
- Installed with KFV security lock (single leaf)
- Three point locking system on single and double leaf
- Top door closer as per EN 1154
- Anti-panic function pursuant to EN179
- Anti-panic function pursuant to EN 1125 (double panic)



**Fire-resistant**  
as per EN 1634-1  
(DIN 4102)



**Sound-insulated**  
as per EN 10140/  
EN 717-1 up to  
RW 38dB<sup>1)</sup>



**Burglary-resistant**  
according to LPS 2081  
Issue 1 Security  
Rating B<sup>1)</sup>

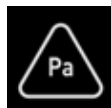

**Pressure-resistant**  
as per BS EN 12211  
pressure 2000 Pa max



# ALWAYS MATCHES YOUR TASTE

Teckentrup doors are delivered with a primer coating in grey-white, similar to RAL 9002. Optional are powder end coatings in accordance with RAL colour map or wooden decorations (technical clarification required).



## SPECIAL ACCENT WITH STAINLESS STEEL

Stainless steel doors are especially dazzling. The representative patterns, matching lever handle sets and handles create a modern, aesthetic room design. Stainless steel doors are also used in areas with special hygienic requirements.



Stainless steel,  
polished  
(240er core)

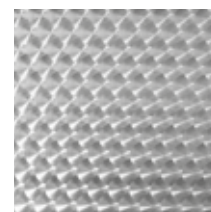

Stainless steel,  
circle-polished  
(marbled)

## HANDING

Our doors are equipped with the most approved single-point and multi-point lockings for high security applications. The lockings offer a robust high security solution for even the harshest environments. Tested and approved on selected single and double doorsets to LPS 1175. Panic Escape functions are also boasted which carry the latest BS EN 179 and BS EN 1125 accreditations.

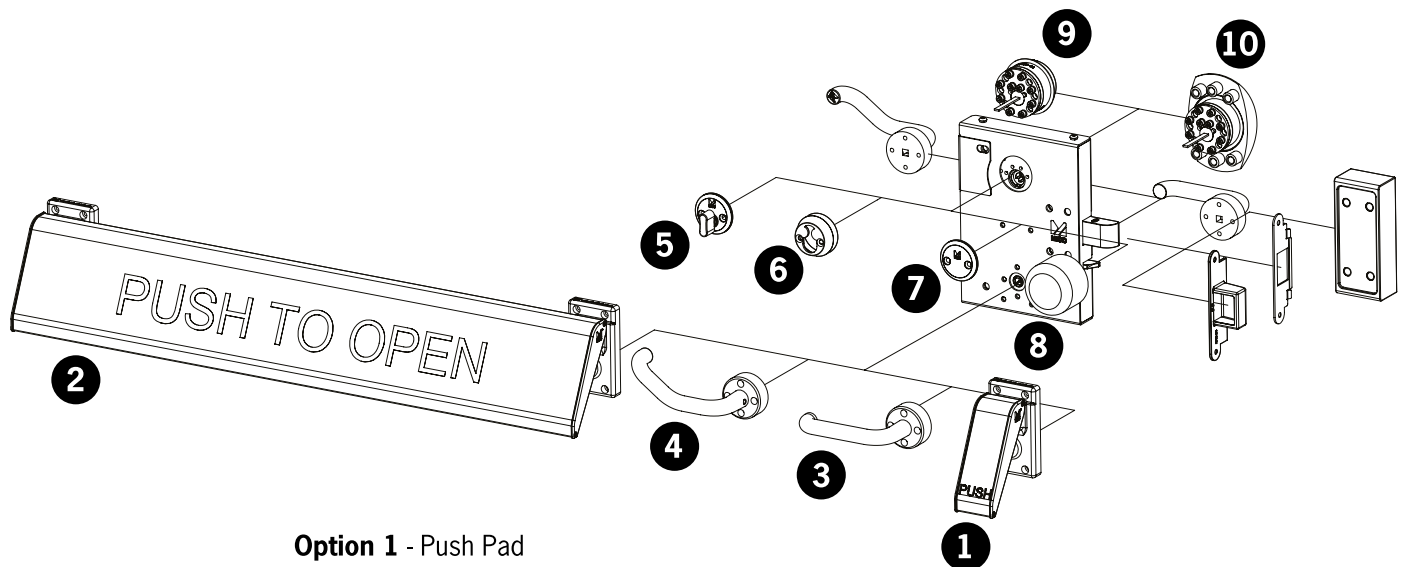
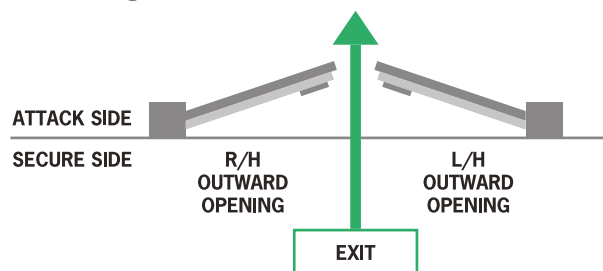

- Option 1** - Push Pad
- Option 2** - Full Width Push Plate
- Option 3** - Lever Handle
- Option 4** - Cranked Lever Handle
- Option 5** - Thumbturn
- Option 6** - Internal Cylinder Ring
- Option 7** - Blind Rose
- Option 8** - Breakdome Thumbturn
- Option 9** - Level 4 Cylinder Guard
- Option 10** - Level 5 Cylinder Guard

## CORNER FRAME

Corner frame for 62er doors, wall plug assembly

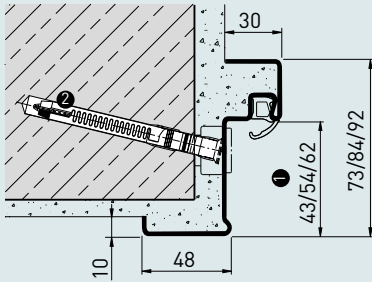

Weld installation with sliding anchor (exposed masonry)

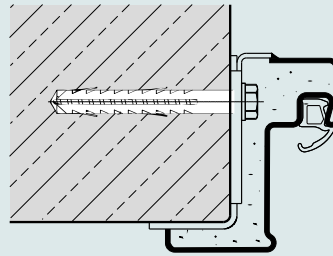

1. Depends on door leaf thickness and rebate construction
2. Installation with frame anchor possible (excluded T60, T90)

Quick and concealed installation with adjustable screws and only one fastening point.



Preferred for use with Secure 1, A, 2, B



# CORNER/COUNTER FRAME

Corner/counter frame for 62 mm doors  
Wall plug installation with slide anchor  
(masonry/concrete)

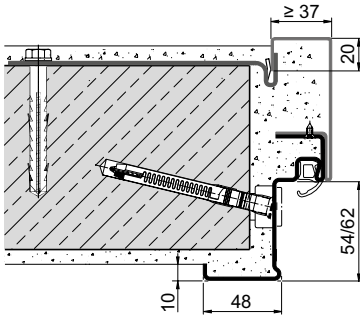

Depends on door leaf thickness and rebate construction

Wall plug and hinged anchor installation (exposed masonry/autoclaved aerated concrete walls)

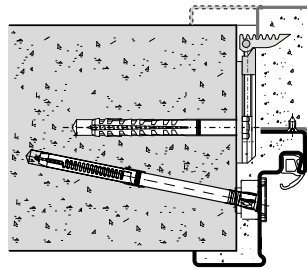

Concealed installation of the counter frame with special fold anchor



Preferred for use with Secure 1, A, 2, B

# BLOCK FRAME

Type 4.1 Wall plug assembly with plaster filling (masonry/autoclaved aerated concrete)

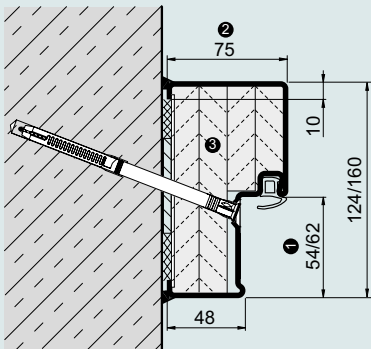

- 1. Depends on door leaf thickness and rebate construction
- 2. For block frame Type 4.2 = 100 mm
- 3. Factory infill optional

Type 4.1 Flush installation (specific fixings for certain levels of security)

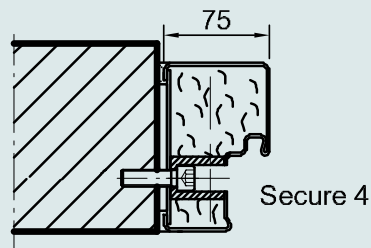
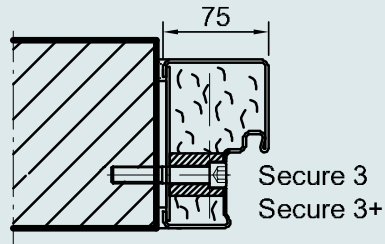

Quick and easy installation of a block frame Type 4.1 with factory infill



Preferred for use with Secure 3, 3+, 4

Main qualification															
DOOR NAME		62-1/2 Secure 1		62-1/2 Secure 2		62-1/2 Secure 3		62-1/2 Secure 3+		62-1/2 Secure 4		62-1/2 Secure A		62-1/2 Secure B	
Number of leaves		Single-leaf	Double-leaf	Single-leaf	Double-leaf	Single-leaf	Double-leaf	Single-leaf	Double-leaf	Single-leaf	Double-leaf	Single-leaf	Double-leaf	Single-leaf	Double-leaf
Product on pages		XX	XX	XX	XX	XX	XX	XX	XX	XX	XX	XX	XX	XX	XX
ADDITIONAL QUALIFICATIONS, STANDARD															
Heat insulation (W/m <sup>2</sup> k)		1,6	1,8	1,6	1,8	1,6	1,8	1,6	1,8	1,6	1,8	1,6	1,8	1,6	1,8
ADDITIONAL QUALIFICATIONS WITH APPROPRIATE EQUIPMENT															
Fire protection		▲	▲	▲	▲	▲	▲	▲	▲	▲	▲	▲	▲	▲	▲
Smoke protection		▲	▲	▲	▲	▲	▲	▲	▲	▲	▲	▲	▲	▲	▲
Sound insulation (dB)		up to 44	up to 37	up to 44	up to 44	42*	41*	42*	41*	42*	41*	up to 44	up to 37	up to 37	up to 38
Anti-burglary characteristics		A1	A1	B3	B3	C5	C5	D5	D5	D10	D10	A	A	B	B
Outdoor use		-	-	-	-	-	-	-	-	-	-	-	-	-	-
Pressure (Pa)		▲	▲	▲	▲	▲	▲	▲	▲	▲	▲	▲	▲	▲	▲
Bullet proof		-	-	▲	-	▲	-	▲	-	▲	-	-	-	▲	-
DOOR LEAF															
Leaf thickness (mm)		62	62	62	62	62	62	62	62	62	62	62	62	62	62
Panel thickness (mm)	primed	1/1.5	1/1.5	1/1.5	1/1.5	1,5	1,5	1,5	1,5	1,5	1,5	1/1.5	1/1.5	1/1.5	1/1.5
	Stainless steel	1	1	1	1	1	1	1	1	1	1	1	1	1	1
Rebate	Thin rebate	■	■	■	■	■	■	■	■	■	■	■	■	■	■
	Thick rebate	-	-	-	-	-	-	-	-	-	-	-	-	-	-
	flush	-	-	-	-	-	-	-	-	-	-	-	-	-	-
Glazing possible		▲	▲	▲	▲	▲	▲	▲	▲	▲	▲	▲	▲	▲	▲
Upper casing/top light possible		-	-	-	-	-	-	-	-	-	-	-	-	-	-
FRAME VARIANTS															
Corner frame		■	■	■	■	■	■	■	■	■	■	■	■	■	■
Counter frame		■	■	■	■	■	■	■	■	■	■	■	■	■	■
Closed frame		■	■	■	■	■	■	■	■	■	■	■	■	■	■
Block frame		■	■	■	■	■	■	■	■	■	■	■	■	■	■
INSTALLATION IN															
Masonry		■	■	■	■	■	■	■	■	■	■	■	■	■	■
Concrete		■	■	■	■	■	■	■	■	■	■	■	■	■	■
Aerated concrete		■	■	■	■	■	■	■	■	■	■	■	■	■	■
Lightweight partition		-	-	-	-	-	-	-	-	-	-	-	-	-	-
BASIC DIMENSION (MM)															
Width	minimum	500	1000	500	1000	500	1000	500	1000	500	1000	500	1000	500	1000
	maximum	1375	2500	1500	3000	1500	4134	1500	4134	1500	4134	1375	2500	1500	3000
Height	minimum	500	500	2000	2000	2000	2000	2000	2000	2000	2000	500	500	2000	2000
	maximum	2500	2500	3000	3000	4167	4167	4167	4167	4167	4167	2500	2500	3000	3000
Max. total height with upper casing		-	-	-	-	-	-	-	-	-	-	-	-	-	-

\* 3000 - 3750 mm height, 42 db, single leaf, 41 db, double leaf

**TECKENTRUP** | PROFESSIONAL



DESIGN | SECURITY | SERVICE

Professional solutions

Subject to technical changes. 01/08/20 (GB) The product images in this brochure are to be regarded as examples. The fitted products therefore do not necessarily correspond to the reference offers. No. 300630

We are happy to help.

**TECKENTRUP**  
DOOR SOLUTIONS

# Samson

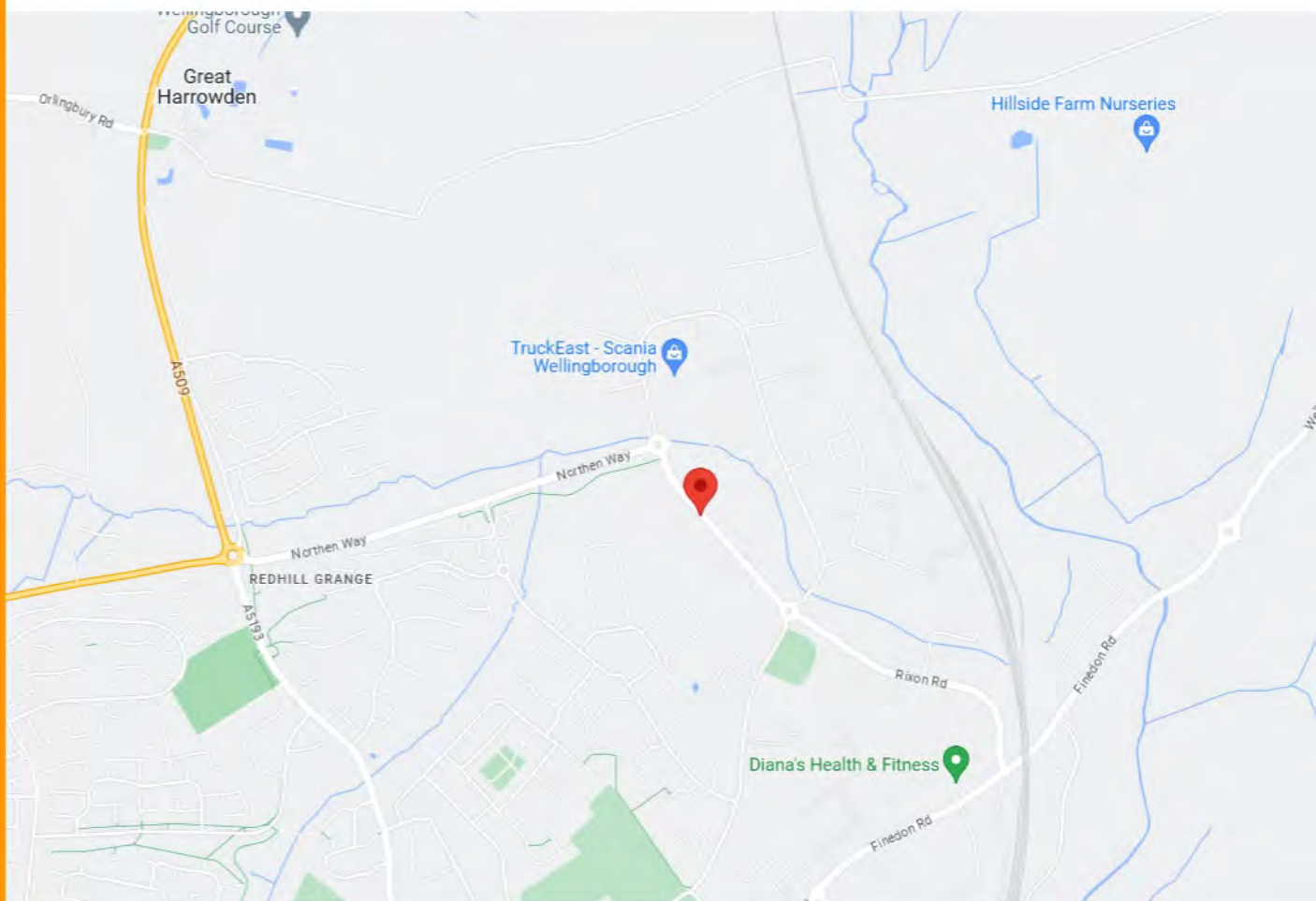

**29-31 STEWARTS ROAD  
WELLINGBOROUGH  
NORTHAMPTONSHIRE  
NN8 4RJ**

**EMAIL: ENQUIRIES@SAMSONDOORS.CO.UK  
TELEPHONE: (01933) 448850  
MON - FRI 8:00AM - 5:00PM**

**SAMSON**

