

Folding arm awning with gear box drive or electric drive

ENGLISH

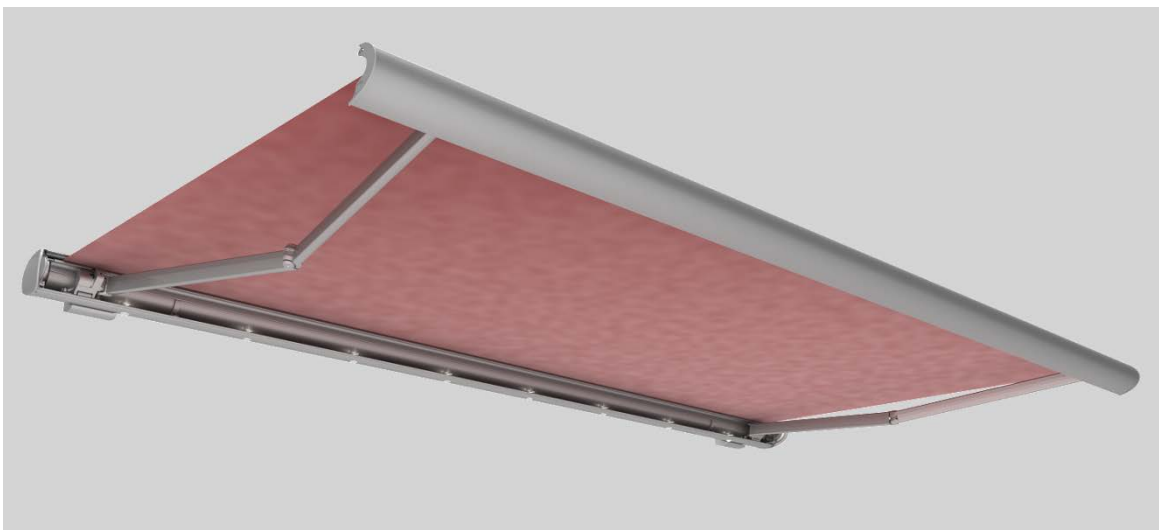

Important guidelines for the end user.

Please read these instructions and observe their contents and warnings before commencing any assembly work.



116542

Contents

1	Reading the Maintenance Instructions and Directions for Use.....	3
1.1	Warnings	3
1.2	Tips and recommendations	3
1.3	Illustrations	3
1.4	Instructions requiring action	3
2	Safety notes	4
2.1	Fundamental safety notes	4
2.1.1	Operation	4
2.1.2	Use in winds	4
2.1.3	Explanation of wind resistance classes	5
2.1.4	Use in rain.....	6
2.1.5	Use in ice and snow.....	6
2.1.6	Obstacles.....	6
2.1.7	Automatic controls	6
2.1.8	Operation during loss of power	6
2.1.9	Checking and monitoring the awning	7
2.2	Intended use.....	7
2.3	Improper use	7
3	Product description.....	8
3.1	Schematic diagram.....	8
3.2	Description of construction and function	8
4	Cleaning	9
4.1	Remove any foliage or foreign bodies.....	9
4.2	Clean the powder-coated aluminium parts.....	9
4.2.1	Saltwater areas	9
4.2.2	In non-saltwater areas.....	9
5	Maintenance.....	10
5.1	Lubricate all moving parts.....	10
5.2	Spare parts.....	10
6	Adjusting the inclination.....	10
7	Rectifying errors/malfunctions.....	11
7.1	Troubleshooting.....	11
8	Conversions or retrofits.....	11
9	Disassembly and disposal.....	11
10	Noise level.....	11



1 Reading the Maintenance Instructions and Directions for Use

Read the Maintenance Instructions and Directions for Use before using the awning for the first time. For personal safety, it is important that these instructions are complied with. Non-compliance means the manufacturer does not carry any liability.

All instructions and directions for use supplied with the awning must be kept by the customer and passed on to the new owner if the awning is sold on.

1.1 Warnings

The warnings differentiate between personal injury and damage to property. The signal word "Danger" is used for personal injury, and "Caution" for property damage.

 DANGER	Immediate danger to life and limb!
 CAUTION	Immediate danger to product and environment!

1.2 Tips and recommendations

	Highlights tips and information that make for correct use of the product.
-----------------------------------------------------------------------------------	---------------------------------------------------------------------------

1.3 Illustrations

Notes on item numbers can be found in the text in parentheses, e.g. (1).

1.4 Instructions requiring action

Instructions requiring action are written in bold print. If the instruction requiring action consists of several individual steps, these have been numbered in the order in which they are to be carried out, e.g. :

1.	Clean the awning
	1. Clean aluminium parts. 2. Clean the awning fabric.

2 Safety notes

2.1 Fundamental safety notes



DANGER

Personal injury

Risk of personal injury due to improper use of the awning.

Please read and observe the safety notes contained in this section.



CAUTION

Product and property damage

Risk of damage to the product and property due to improper use of the awning.

Please read and observe the safety notes contained in this section.

2.1.1 Operation

It must be assured that no children or people unable to properly assess the risks of improper or incorrect use should be able to operate the awning. Remote controls must be kept out of reach of children.

The installation and setting instructions supplied separately by the manufacturer of the motor, switches and controls must also be observed.

2.1.2 Use in winds

The awning complies with the requirements of the wind resistance class shown on the CE declaration of conformity printed in the Assembly Instructions. The wind resistance class achieved after installation of the awning is heavily dependent on the type and number of fixings used as well as the installation surface involved.

The awning may only be used up to the wind resistance class specified by the company fitting the awning. This may deviate from the wind resistance class stated by the manufacturer.

2.1.3 Explanation of wind resistance classes

Wind resistance class 0



Wind resistance class 0 equates (in accordance with DIN EN 13561) either to a level of performance that is not required or has not been measured, or to a product that does not meet the requirements of Class 1. The awning must never be used in windy conditions.

Wind resistance class 1



The awning may only remain open until winds have reached force 4.

Definition acc. to the Beaufort scale: light breeze, light wind
Wind moves small tree branches and twigs, lifts dust and loose paper
Wind speed 20-27 km/h = 5.5-7.4 m/s

Wind resistance class 2



The awning may only remain open until winds have reached force 5.

Definition acc. to the Beaufort scale: fresh breeze, fresh wind
Small trees in leaf begin to sway;
whitecaps form at sea.
Wind speed 28-37 km/h = 7.5-10.4 m/s

Wind resistance class 3

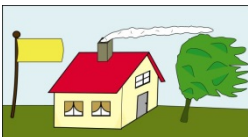

The awning may only remain open until winds have reached force 6.

Definition acc. to Beaufort scale: strong breeze
Larger tree branches move, umbrellas are hard to hold, telegraph masts whistle in the wind
Wind speed 38-48 km/h = 10.5-13.4 m/s

Source: German Met Office (DWD) - Offenbach

2.1.4 Use in rain

If the awning is pitched at less than 25% = 14°, measured from a horizontal position, it must not be opened during rainfalls. There is a risk of water pooling in the awning fabric which could result in damage to the awning.

2.1.5 Use in ice and snow

The awning must not be opened in snowfalls or when there is a risk of frost. There is a risk that the awning could be damaged.

The automatic controls must be switched off if there is a risk of frost.

2.1.6 Obstacles

The space needed for the awning to open must always be kept clear. There is risk of people being trapped there.

2.1.7 Automatic controls

An open awning must never be left unattended when open. The automatic controls may fail under extreme conditions (e.g. loss of power, defects, sudden storms). There is a risk that the awning could be damaged or crash down.

Our recommendation: if you vacate the area, switch the awning from automatic to manual control and leave the awning retracted.

If there is a risk of frost, the awning must be switched from automatic to manual control to prevent it from opening automatically. The unit must not be used in frosty conditions or if there is a risk of frost.

2.1.8 Operation during loss of power

A motorised awning cannot close if there is no power. In very windy areas where losses in power are common, consider using a manual emergency device (not included with all models). The manual emergency device must be installed at a height of no more than 1.80 metres. If there is a risk of frost, the awning must be switched from automatic to manual control to prevent it from opening automatically.

The unit must not be used in frosty conditions or if there is a risk of frost.

In an emergency, if the awning's built-in motor fails and a gale or storm is impending, the awning can be retracted using ropes or lashing belts as a makeshift solution. In this instance, wrap a rope or lashing belt around the centre joints of the awning arms and then tighten until the awning is securely closed. The folding arms must also be secured to the awning frame to prevent them from swinging out. Roll up the overhanging cloth and tie it to the awning. The aim here is to give the wind as little area to work with as possible.

2.1.9 Checking and monitoring the awning

For personal safety, it is important that these safety notes are complied with and kept in a safe place.

- The performance of a product depends on how it is assembled and installed.
- Check the awning system for signs of wear or damage.
- On motorised systems, check the electrical cables and leads for damage.
- Do not use units that are in need of repair.
- Monitor the awning when it opens and retracts and keep people clear of the area until the awning has fully opened or retracted.
- The assembly work may only be performed by trained personnel.

Guidelines for units with automatic controls

- When performing maintenance or installation work on the covered area of the awning, disconnect the awning from the power supply.

2.2 Intended use

Awnings are designed to open in order to shade exposed areas from undesired sun. Failure to use the awning as intended may result in severe danger.

Alterations, such as attaching items or conversions, not envisaged by weinor may only be carried out with the manufacturer's written consent.

Additional loads on the awning caused by hanging objects from it or by anchoring ropes may result in damage or cause the awning to fall and are therefore not permissible.

2.3 Improper use

Only use original spare parts on the awning. Only use the awning as a sun protection device. Never affix/hang heavy objects to/from the awning. Never open the awning or allow it to be opened in winds stronger than wind class 2.

3 Product description

3.1 Schematic diagram

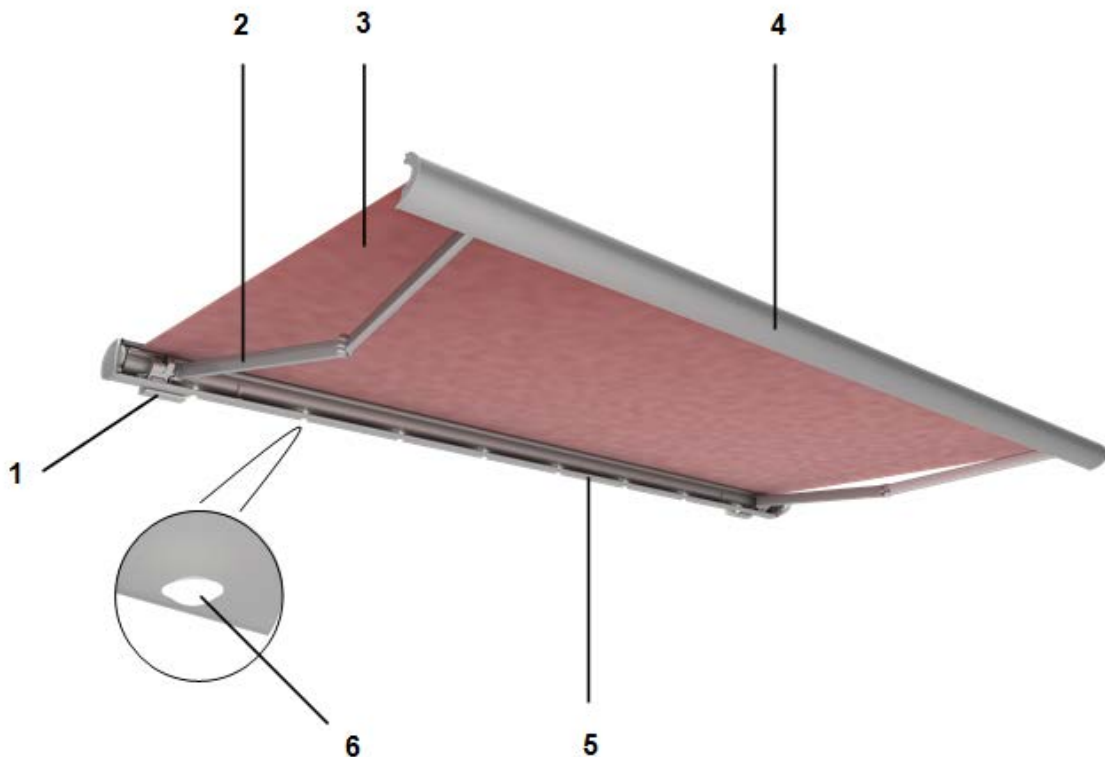

Figure 1: Schematic diagram of Opal Design II/ Opal Design II LED

1	Wall bracket	4	Drop profile
2	Spring-tensionend arm	5	Support profile
3	Fabric	6	LED spotlight

3.2 Description of construction and function

The weinor Opal Design II/ Opal Design II LED is a cassette awning with a fabric that opens to protect against the sun. It can be tilted to an angle of between 5° and 40° as desired.

The weinor Opal Design II LED has integrated LED spotlights inside the cassette to create welcoming outdoor lighting. Space has been left at the openings on the housing for the LED spotlights to allow water to escape. The cables are suitably splash-protected.

Only high-quality, rust-free materials are used in the weinor Opal Design II. The profiles are made of extruded aluminium. All connecting parts, such as screws, are made of stainless steel.

4 Cleaning

DANGER

Personal injury

There is a risk of motorised awnings being activated unintentionally.

- ▶ **Disconnect the awning from the power supply (e.g. by disconnecting the fuse) before doing any cleaning work.**
- ▶ **If awnings are operated by several users, a priority locking device must be activated (controlled interruption of the power supply from outside), making it impossible to open or retract the awning at all.**

4.1 Remove any foliage or foreign bodies

Foliage and other foreign bodies lying on the awning fabric and the awning housing must be removed immediately. There is a risk that the awning could be damaged or crash down.

4.2 Clean the powder-coated aluminium parts

4.2.1 Saltwater areas

CAUTION

Product damage

In saltwater areas, there is a distinct possibility that salt may disperse or accumulate on the product.

- ▶ **Wash off any salt deposits at regular intervals or as required, but no less than twice a year.**

Recommendation: call in a specialist company to do the work for you.

This is a good way to protect the aluminium parts and their surface from being corroded by salty water.

4.2.2 In non-saltwater areas

Clean the aluminium parts at least once a year, and even more often if heavily soiled. To clean, use clean water and add a few drops of pH-neutral or very slightly alkaline detergent.

5 Maintenance

DANGER

Personal injury

The safe and risk-free use of the awning can only be guaranteed if the product is checked and serviced on a regular basis.

- ▶ **Observe the maintenance requirements and maintenance intervals.**
- ▶ **Inspect the awning at regular intervals for signs of wear and tear or damage to the awning fabric and frame.**
- ▶ **Check the awning at regular intervals for signs of damage to the cables.**
- ▶ **Do not use units in need of repair. Ensure people keep clear of any dangerous areas.**
- ▶ **Should you detect any damage, contact a specialist retailer or dealer or a suitable service company to carry out the repairs.**



Carry out maintenance and care tasks as required, once every spring, or whenever the awning has not been in use for a long time. Performing these tasks will extend the service life of your awning system.

Our recommendation: call in a specialist company to carry out the necessary maintenance and care work.

5.1 Lubricate all moving parts

CAUTION

Product damage

Use greases, sprays or liquids that contain elements of teflon, PTFE or comparable agents. For best effects, use a water- and dirt-repellent lubricant.

- ▶ **The manufacturer's guidelines must be observed.**
- ▶ **Do not use lubricants that corrode plastics.**

Lubricating points (X)

- Flange sleeves in upper arm insert

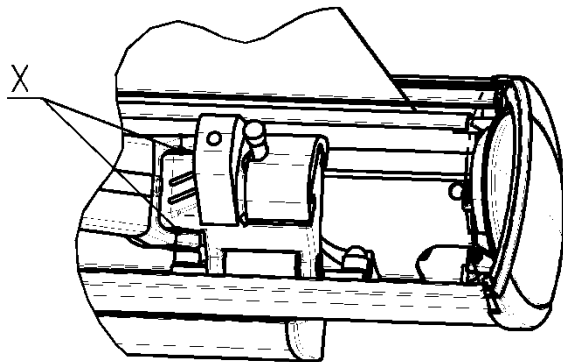

5.2 Spare parts

Only spare parts approved by weinor may be used:

6 Adjusting the inclination

Permissible range of adjustment: Opal Design II 5° to 40°, with a projection >351 cm and pitch of 7° - 40°. We recommend setting all awnings to an angle of more than 5°. To adjust the angle of inclination, open the awning and slightly lift the arm in question to reduce the strain.

7 Rectifying errors/malfunctions

Our recommendation: defects should only be repaired by your specialist retailer or partner.

Please bear in mind that defects that are not repaired properly will compromise the safety of your awning system.

You should therefore call your specialist retailer or dealer immediately. Your specialist local retailer or dealer will gladly provide you with swift, qualified advice. To help you troubleshoot, a few errors are listed below.

7.1 Troubleshooting

Error	Cause	Remedy
<ul style="list-style-type: none"> Motor not running 	<ul style="list-style-type: none"> No power Motor incorrectly connected Motor is too warm and has been shut down by the thermo protector 	<ul style="list-style-type: none"> Connect to the mains Connect to the mains (authorised personnel only) Wait approx. 15 to 20 minutes until the motor has cooled down
<ul style="list-style-type: none"> Squeaking 	<ul style="list-style-type: none"> Bearing surfaces not lubricated 	<ul style="list-style-type: none"> Maintenance and care (fitter)

8 Conversions or retrofits

Your awning can only be converted or retrofitted to a limited extent.

The following conversions are possible:

- Replace fabric
- Wind support

Your awning can also be retrofitted with automatic controls, e. g. with sun and rain sensors. Contact your local dealer for more details, who will be happy to advise you.

9 Disassembly and disposal

Although this product does not contain any materials which pose a risk or danger to the environment, the awning parts should nevertheless be disposed of properly. When dismantling and disposing of the awning, fully slacken or secure the tensioned parts (e.g. folding arms) to prevent them from opening or extending automatically. A suitably qualified company should be engaged to perform this task.

10 Noise level

When installed, the awning's noise level has been measured at below 70 dB(A).

The Weinor logo consists of a white lowercase 'we' followed by a white dot above the 'i', and the lowercase 'nor' in a bold, sans-serif font, all set against a red square background.

weinor GmbH & Co. KG
Mathias-Brüggen-Straße 110
50829 Cologne (Germany)
www.weinor.com
Hotline: +49(0)221/5 97 09-214
Fax: +49(0)221/5 97 09-898